

Contents

	Page
D-Sub adapter	40.02
Han® Split Hood	40.04
Cable entry protection with metric cable entries	40.06
Cable entry protection with Pg cable entries	40.08
Coding for Hoods/Housings and inserts	40.11
PE Multiple ground connection	40.12
Han® Docking frame	40.14
Grip frame	40.16
Ground terminal	40.18
Clamps	40.19
Special insert fixing screws	40.21
Screws	40.23
Locking levers	40.24
Protection covers	40.25
Gaskets, seals	40.26

Number of contacts

9 - 50



D-Sub adapters for Han A® hoods/housings

Identification	Size	Part number	D-Sub size	Drawing	Dimensions in mm								
Plastic adapter for 1 x D-Sub ¹⁾	10 A	09 20 000 9932	9										
	10 A	09 20 000 9928	15										
	10 A	09 20 000 9929	25		<table border="1"> <thead> <tr> <th>Size</th> <th>D-Sub</th> <th>c</th> </tr> </thead> <tbody> <tr> <td>10 A</td> <td>15</td> <td>33.3</td> </tr> <tr> <td>10 A</td> <td>25</td> <td>47</td> </tr> </tbody> </table>	Size	D-Sub	c	10 A	15	33.3	10 A	25
Size	D-Sub	c											
10 A	15	33.3											
10 A	25	47											
Range of delivery: 1 adapter 4 fixing screws for adapter 2 fixing screws for D-Sub connector													
Metal adapter for 1 x D-Sub ¹⁾	10 A	09 20 000 9925	25										
	16 A		37										
Range of delivery: 1 adapter 4 fixing screws for adapter 2 fixing screws for D-Sub connector													

Accessories

40
02

¹⁾ only for standard D-Sub, not for HD D-Sub

Stock items in bold type

Number of contacts

9 - 50



D-Sub adapters for Han® B hoods/housings

Identification	Size	Part number	D-Sub size	Drawing	Dimensions in mm																																
Plastic adapter for 1 x D-Sub ¹⁾	6 B	09 30 000 9965	9	<p>① Mounting in housing: character A visible ② Mounting in hood: character T visible</p> <table border="1"> <thead> <tr> <th>Size</th> <th>D-Sub</th> <th>a</th> <th>b</th> <th>c</th> </tr> </thead> <tbody> <tr> <td>6 B</td> <td>9</td> <td>44</td> <td>51.5</td> <td>25</td> </tr> <tr> <td>6 B</td> <td>15</td> <td>44</td> <td>51.5</td> <td>33.3</td> </tr> <tr> <td>10 B</td> <td>25</td> <td>57</td> <td>64.5</td> <td>47</td> </tr> <tr> <td>16 B</td> <td>37</td> <td>77.5</td> <td>85</td> <td>63.5</td> </tr> <tr> <td>16 B</td> <td>50</td> <td>77.5</td> <td>85</td> <td>61.1</td> </tr> </tbody> </table>	Size	D-Sub	a	b	c	6 B	9	44	51.5	25	6 B	15	44	51.5	33.3	10 B	25	57	64.5	47	16 B	37	77.5	85	63.5	16 B	50	77.5	85	61.1	6 B	09 30 000 9966	15
	Size	D-Sub	a		b	c																															
	6 B	9	44		51.5	25																															
	6 B	15	44		51.5	33.3																															
	10 B	25	57		64.5	47																															
16 B	37	77.5	85	63.5																																	
16 B	50	77.5	85	61.1																																	
10 B	09 30 000 9967	25																																			
16 B	09 30 000 9968	37																																			
16 B	09 30 000 9969	50																																			
Range of delivery: 1 adapter 4 fixing screws for adapter 2 fixing screws for D-Sub connector																																					
Plastic adapter for 2 x D-Sub ¹⁾	6 B	09 30 000 9970	2 x 9	<p>① Mounting in housing: character A visible ② Mounting in hood: character T visible</p> <table border="1"> <thead> <tr> <th>Size</th> <th>D-Sub</th> <th>a</th> <th>b</th> <th>c</th> </tr> </thead> <tbody> <tr> <td>6 B</td> <td>9</td> <td>44</td> <td>51.5</td> <td>15</td> </tr> <tr> <td>6 B</td> <td>15</td> <td>44</td> <td>51.5</td> <td>33.3</td> </tr> <tr> <td>10 B</td> <td>25</td> <td>57</td> <td>64.5</td> <td>47</td> </tr> <tr> <td>16 B</td> <td>37</td> <td>77.5</td> <td>85</td> <td>63.5</td> </tr> <tr> <td>16 B</td> <td>50</td> <td>77.5</td> <td>85</td> <td>61.1</td> </tr> </tbody> </table>	Size	D-Sub	a	b	c	6 B	9	44	51.5	15	6 B	15	44	51.5	33.3	10 B	25	57	64.5	47	16 B	37	77.5	85	63.5	16 B	50	77.5	85	61.1	6 B	09 30 000 9971	2 x 15
	Size	D-Sub	a		b	c																															
	6 B	9	44		51.5	15																															
	6 B	15	44		51.5	33.3																															
	10 B	25	57		64.5	47																															
16 B	37	77.5	85	63.5																																	
16 B	50	77.5	85	61.1																																	
10 B	09 30 000 9972	2 x 25																																			
16 B	09 30 000 9973	2 x 37																																			
16 B	09 30 000 9974	2 x 50																																			
Range of delivery: 1 adapter 4 fixing screws for adapter 4 fixing screws for D-Sub connector																																					

¹⁾ only for standard D-Sub, not for HD D-Sub

Features

- Compatible with Han® housings, bulkhead mounting, with 2 levers, standard panel cut out
- Allows the entry of pre-assembled cables into a switch cabinet
- Use of identification strips is possible
- No special tools required for assembly
- Standard screw driver (5 x 1 mm) necessary to open split hood

Technical characteristics

Split Hood

Material	polycarbonate
Flammability acc. to UL 94	V 0
Limiting temperatures	-40 °C ... +125 °C
Cable entries	3, 4
Degree of protection in locked position with correct grommet	IP 54 when mounted vertically in the longitudinal direction
Max. cable diameter	3 ... 16
Locking cycles of bulkhead mounted housings	≥ 50
Locking cycles of split hood halves	≥ 10

Cable entry glands

Material	Thermoplastic rubber, UL listed
Limiting temperatures	-40 °C ... +125 °C
Colour	black

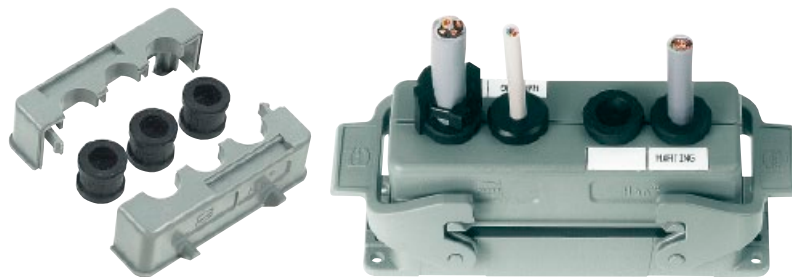

with up to 4 cable entries

Identification	Size	Part number	Drawing	Dimensions in mm												
Split Hood for 3 cable entries for 4 cable entries Range of delivery: 2 split hood halves Cable entry glands order separately	16 B 24 B	09 30 016 0408 09 30 024 0408														
Housings bulkhead mounting 	16 B 24 B	09 30 016 0301 09 30 024 0301	<table border="1"> <thead> <tr> <th>Size</th> <th>a</th> <th>b</th> <th>Panel cut out</th> </tr> </thead> <tbody> <tr> <td>16 B</td> <td>103</td> <td>113</td> <td>82 x 35</td> </tr> <tr> <td>24 B</td> <td>130</td> <td>140</td> <td>108 x 35</td> </tr> </tbody> </table>	Size	a	b	Panel cut out	16 B	103	113	82 x 35	24 B	130	140	108 x 35	
Size	a	b	Panel cut out													
16 B	103	113	82 x 35													
24 B	130	140	108 x 35													
Identification	cable Ø	Part number	Drawing	Dimensions in mm												
Cable entry glands from Ø 10 mm upwards additional strain relief can be provided by cable ties (max. width 8 mm) for ASI cable	3...4 4...5 5...6 6...7 7...8 8...9 9...10 10...11 11...12 12...13 13...14 14...15 15...16 -	09 00 000 5351 09 00 000 5352 09 00 000 5353 09 00 000 5354 09 00 000 5355 09 00 000 5356 09 00 000 5357 09 00 000 5358 09 00 000 5359 09 00 000 5360 09 00 000 5361 09 00 000 5362 09 00 000 5363 09 00 000 5364														
blind grommet	-	09 00 000 5350														
Identification strips order separately 20 pieces in one block 9 mm width / 20 mm length	-	09 33 000 9982														

Accessories

Identification Part number M Drawing Dimensions in mm

Cable entry protection
with metric cable entries (IP 68)
metal



19 00 000 5080 20
19 00 000 5081 20
19 00 000 5082 20
19 00 000 5084 20
19 00 000 5090 25
19 00 000 5091 25

19 00 000 5092 25
19 00 000 5094 32
19 00 000 5095 32

19 00 000 5096 32
19 00 000 5097 40
19 00 000 5098 40
19 00 000 5099 40

19 00 000 5086 50

SW	E	Outer cable \varnothing	Nm
22	24.4	5 ... 9 mm	10
22	24.4	5 ... 9 mm	10
		6 ... 12 mm	
22	24.4	6 ... 12 mm	10
24	26.5	10 ... 14 mm	10
30	33.5	9 ... 16 mm	15
30	33.5	9 ... 16 mm	15
		13 ... 18 mm	
30	33.5	13 ... 18 mm	15
40	44	13 ... 20 mm	15
40	44	13 ... 20 mm	15
		18 ... 25 mm	
40	44	18 ... 25 mm	15
50	55	20 ... 26 mm	20
50	55	22 ... 32 mm	20
50	55	20 ... 26 mm	20
50	55	22 ... 32 mm	20
57	60	32 ... 38 mm	24

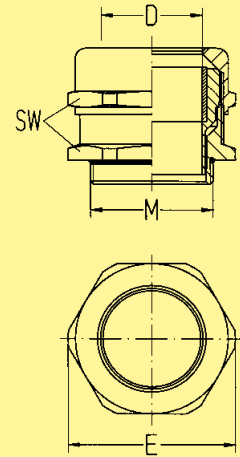

thermoplastic



19 00 000 5180 20
19 00 000 5182 20
19 00 000 5184 20
19 00 000 5190 25
19 00 000 5192 25
19 00 000 5194 32
19 00 000 5196 32
19 00 000 5197 40
19 00 000 5198 40

24	26.4	5 ... 9 mm	8
24	26.4	6 ... 12 mm	8
27	29.8	10 ... 14 mm	10
33	33.5	9 ... 16 mm	15
33	36.5	13 ... 18 mm	15
42	46.8	13 ... 20 mm	15
42	46.8	18 ... 25 mm	15
53	58.8	20 ... 26 mm	15
53	58.8	22 ... 32 mm	15

EMC clamp
with metric cable entries (IP 68)





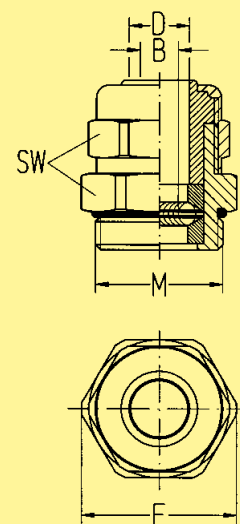

19 62 000 5080 20
19 62 000 5081 20
19 62 000 5082 20
19 62 000 5084 20
19 62 000 5090 25
19 62 000 5092 25
19 62 000 5094 32
19 62 000 5096 32
19 62 000 5097 40
19 62 000 5098 40



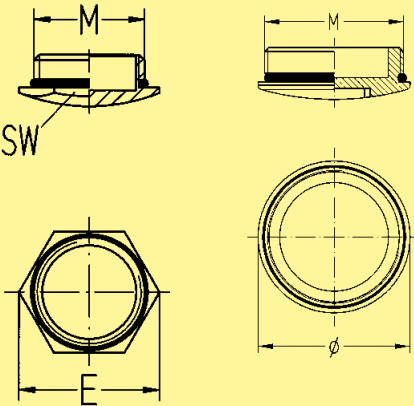

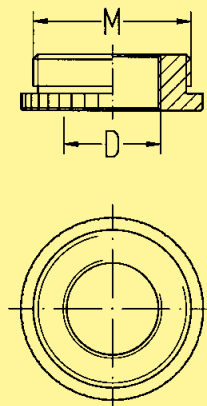
SW	E	cabl- \varnothing D	shield- \varnothing B
22	24.4	6.5 ... 9.5	3.5 ... 8.5
22	24.4	4 ... 6.5	2.5 ... 6.5
22	24.4	7 ... 10.5	6.5 ... 10.5
22	24.4	9 ... 13	6.5 ... 10.5
22	31.2	6.5 ... 9.5	3 ... 8
28	31.2	9 ... 13	4.8 ... 8
35	38.5	11.5 ... 15.5	8 ... 13.5
35	38.5	14 ... 18	9 ... 14.5
43	47.3	17 ... 20.5	15 ... 20
43	47.3	20 ... 25	15 ... 20

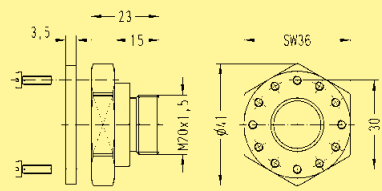
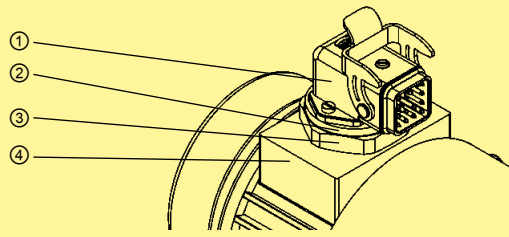



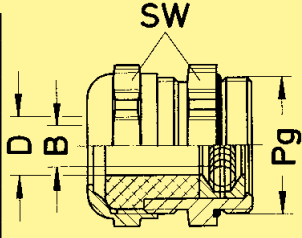
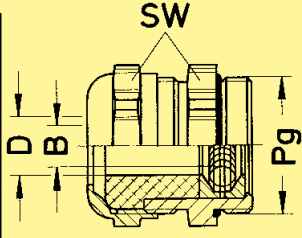

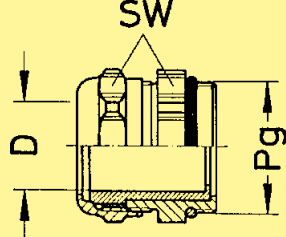
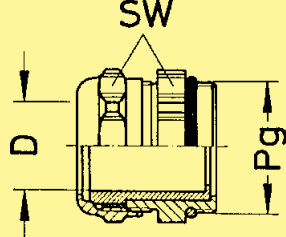

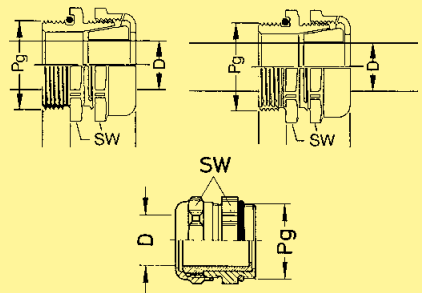
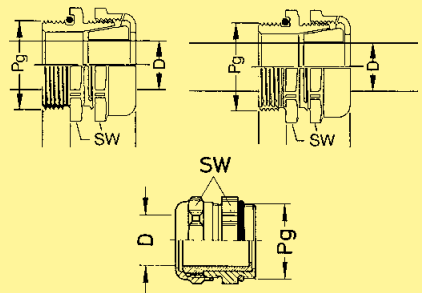

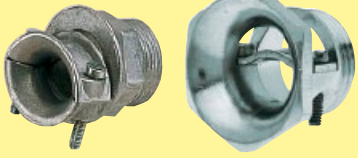

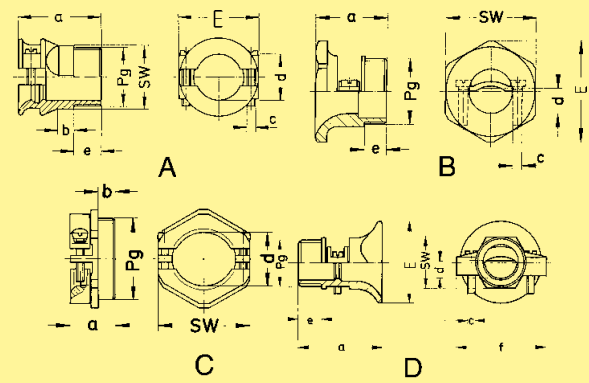

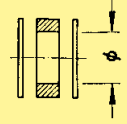

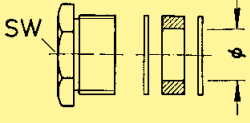

Accessories

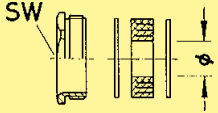
Identification	Part number	M	Drawing	Dimensions in mm											
Blanking piece for metric cable entries metal		19 00 000 5070	20	<table border="1"> <thead> <tr> <th>SW</th> <th>E</th> </tr> </thead> <tbody> <tr> <td>22</td> <td>25.4</td> </tr> <tr> <td>28</td> <td>32.3</td> </tr> <tr> <td>35</td> <td>40.4</td> </tr> <tr> <td>44</td> <td>50.8</td> </tr> </tbody> </table>	SW	E	22	25.4	28	32.3	35	40.4	44	50.8	
		SW	E												
		22	25.4												
		28	32.3												
	35	40.4													
	44	50.8													
19 00 000 5071	25														
19 00 000 5072	32														
19 00 000 5073	40														
19 00 000 5172	32	<table border="1"> <thead> <tr> <th>∅</th> </tr> </thead> <tbody> <tr> <td>35</td> </tr> <tr> <td>46.2</td> </tr> </tbody> </table>	∅	35	46.2										
∅															
35															
46.2															
19 00 000 5173	40														
Reducers for metric cable entries metal		19 00 000 5060	20	<table border="1"> <thead> <tr> <th>D</th> </tr> </thead> <tbody> <tr> <td>16</td> </tr> <tr> <td>20</td> </tr> <tr> <td>25</td> </tr> </tbody> </table>	D	16	20	25							
		D													
		16													
20															
25															
19 00 000 5067	32														
19 00 000 5068	32														
Adapter Han® 3 A for motor connection		19 20 000 9962	20	 <p>sample for mounting:</p>  <ul style="list-style-type: none"> ① Han® 3 A housing, bulkhead mounting ② sealing ③ adapter ④ housing for motor applications 											

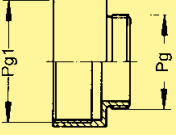
Cable entry protection with Pg cable entries

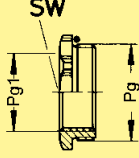

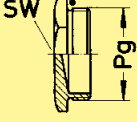

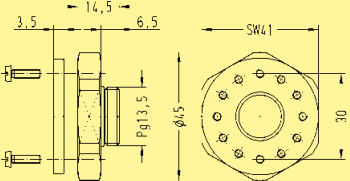

Identification	Part number	Pg	Drawing	Dimensions in mm																																																															
EMC clamp with Pg cable entries (IP 68) 	09 62 000 5023	11	<table border="1"> <thead> <tr> <th>SW</th> <th>cablе-Ø D</th> <th>shield-Ø B</th> </tr> </thead> <tbody> <tr><td>20</td><td>4 ... 6.5</td><td>2.5 ... 6.5</td></tr> <tr><td>20</td><td>6.5 ... 9.5</td><td>3.5 ... 8.5</td></tr> <tr><td>22</td><td>8 ... 10.5</td><td>6.5 ... 10.5</td></tr> <tr><td>22</td><td>6.5 ... 9.5</td><td>2.5 ... 6.5</td></tr> <tr><td>22</td><td>9 ... 13</td><td>6.5 ... 10.5</td></tr> <tr><td>24</td><td>6.5 ... 9.5</td><td>3.5 ... 8</td></tr> <tr><td>24</td><td>9 ... 13</td><td>4.5 ... 8</td></tr> <tr><td>30</td><td>11.5 ... 15.5</td><td>9.5 ... 13.5</td></tr> <tr><td>30</td><td>14 ... 18</td><td>10.5 ... 14.5</td></tr> <tr><td>40</td><td>17 ... 20.5</td><td>15 ... 20</td></tr> <tr><td>40</td><td>20 ... 25</td><td>15 ... 20</td></tr> <tr><td>50</td><td>24 ... 28</td><td>18 ... 25.5</td></tr> <tr><td>50</td><td>27 ... 32</td><td>24 ... 31</td></tr> </tbody> </table> 	SW	cablе-Ø D	shield-Ø B	20	4 ... 6.5	2.5 ... 6.5	20	6.5 ... 9.5	3.5 ... 8.5	22	8 ... 10.5	6.5 ... 10.5	22	6.5 ... 9.5	2.5 ... 6.5	22	9 ... 13	6.5 ... 10.5	24	6.5 ... 9.5	3.5 ... 8	24	9 ... 13	4.5 ... 8	30	11.5 ... 15.5	9.5 ... 13.5	30	14 ... 18	10.5 ... 14.5	40	17 ... 20.5	15 ... 20	40	20 ... 25	15 ... 20	50	24 ... 28	18 ... 25.5	50	27 ... 32	24 ... 31																						
	SW	cablе-Ø D		shield-Ø B																																																															
	20	4 ... 6.5		2.5 ... 6.5																																																															
	20	6.5 ... 9.5		3.5 ... 8.5																																																															
	22	8 ... 10.5		6.5 ... 10.5																																																															
	22	6.5 ... 9.5		2.5 ... 6.5																																																															
	22	9 ... 13		6.5 ... 10.5																																																															
	24	6.5 ... 9.5		3.5 ... 8																																																															
	24	9 ... 13		4.5 ... 8																																																															
	30	11.5 ... 15.5		9.5 ... 13.5																																																															
	30	14 ... 18		10.5 ... 14.5																																																															
	40	17 ... 20.5		15 ... 20																																																															
	40	20 ... 25		15 ... 20																																																															
	50	24 ... 28		18 ... 25.5																																																															
	50	27 ... 32		24 ... 31																																																															
09 62 000 5024	11																																																																		
09 62 000 5025	11																																																																		
09 62 000 5003	13.5																																																																		
09 62 000 5004	13.5																																																																		
09 62 000 5005	16																																																																		
09 62 000 5006	16																																																																		
09 62 000 5007	21																																																																		
09 62 000 5008	21																																																																		
09 62 000 5009	29																																																																		
09 62 000 5010	29																																																																		
09 62 000 5011	36																																																																		
09 62 000 5012	36																																																																		
Universal cable gland Pg (IP 68) Metal 	09 00 000 5080	11	<table border="1"> <thead> <tr> <th>Colour</th> <th>SW</th> <th>cablе-Ø D</th> </tr> </thead> <tbody> <tr><td>grey</td><td>20</td><td>5 ... 8</td></tr> <tr><td>black</td><td>20</td><td>6.5 ... 9.5</td></tr> <tr><td>green</td><td>20</td><td>7 ... 10.5</td></tr> <tr><td>black</td><td>22</td><td>6.5 ... 9.5</td></tr> <tr><td>green</td><td>22</td><td>7 ... 10.5</td></tr> <tr><td>red</td><td>22</td><td>9 ... 13</td></tr> <tr><td>black</td><td>24</td><td>6.5 ... 9.5</td></tr> <tr><td>green</td><td>24</td><td>7 ... 10.5</td></tr> <tr><td>red</td><td>24</td><td>9 ... 13</td></tr> <tr><td>white</td><td>24</td><td>11.5 ... 15.5</td></tr> <tr><td>green</td><td>30</td><td>7 ... 10.5</td></tr> <tr><td>red</td><td>30</td><td>9 ... 13</td></tr> <tr><td>white</td><td>30</td><td>11.5 ... 15.5</td></tr> <tr><td>blue</td><td>30</td><td>14 ... 18</td></tr> <tr><td>blue</td><td>40</td><td>14 ... 18</td></tr> <tr><td>brown</td><td>40</td><td>17 ... 21</td></tr> <tr><td>orange</td><td>40</td><td>20 ... 25</td></tr> <tr><td>light yellow</td><td>40</td><td>24 ... 28</td></tr> <tr><td>light blue</td><td>50</td><td>29 ... 34</td></tr> <tr><td>pink</td><td>50</td><td>32 ... 36</td></tr> </tbody> </table> 	Colour	SW	cablе-Ø D	grey	20	5 ... 8	black	20	6.5 ... 9.5	green	20	7 ... 10.5	black	22	6.5 ... 9.5	green	22	7 ... 10.5	red	22	9 ... 13	black	24	6.5 ... 9.5	green	24	7 ... 10.5	red	24	9 ... 13	white	24	11.5 ... 15.5	green	30	7 ... 10.5	red	30	9 ... 13	white	30	11.5 ... 15.5	blue	30	14 ... 18	blue	40	14 ... 18	brown	40	17 ... 21	orange	40	20 ... 25	light yellow	40	24 ... 28	light blue	50	29 ... 34	pink	50	32 ... 36	
	Colour	SW		cablе-Ø D																																																															
	grey	20		5 ... 8																																																															
	black	20		6.5 ... 9.5																																																															
	green	20		7 ... 10.5																																																															
	black	22		6.5 ... 9.5																																																															
	green	22		7 ... 10.5																																																															
	red	22		9 ... 13																																																															
	black	24		6.5 ... 9.5																																																															
	green	24		7 ... 10.5																																																															
	red	24		9 ... 13																																																															
	white	24		11.5 ... 15.5																																																															
	green	30		7 ... 10.5																																																															
	red	30		9 ... 13																																																															
	white	30		11.5 ... 15.5																																																															
	blue	30		14 ... 18																																																															
	blue	40		14 ... 18																																																															
	brown	40		17 ... 21																																																															
	orange	40		20 ... 25																																																															
	light yellow	40		24 ... 28																																																															
	light blue	50		29 ... 34																																																															
	pink	50		32 ... 36																																																															
	09 00 000 5081	11																																																																	
	09 00 000 5082	11																																																																	
	09 00 000 5083	13.5																																																																	
	09 00 000 5084	13.5																																																																	
	09 00 000 5085	13.5																																																																	
09 00 000 5086	16																																																																		
09 00 000 5087	16																																																																		
09 00 000 5088	16																																																																		
09 00 000 5089	16																																																																		
09 00 000 5090	21																																																																		
09 00 000 5091	21																																																																		
09 00 000 5092	21																																																																		
09 00 000 5093	21																																																																		
09 00 000 5094	29																																																																		
09 00 000 5095	29																																																																		
09 00 000 5096	29																																																																		
09 00 000 5097	29																																																																		
09 00 000 5098	36																																																																		
09 00 000 5099	36																																																																		
Cable entry protection with Pg cable entries (IP 68) Accessories 	09 00 000 5183	11	<table border="1"> <thead> <tr> <th>SW</th> <th>cablе-Ø D</th> </tr> </thead> <tbody> <tr><td>21</td><td>7 ... 12</td></tr> <tr><td>24</td><td>7 ... 12</td></tr> <tr><td>33</td><td>13 ... 18</td></tr> </tbody> </table> 	SW	cablе-Ø D	21	7 ... 12	24	7 ... 12	33	13 ... 18																																																								
	SW	cablе-Ø D																																																																	
	21	7 ... 12																																																																	
	24	7 ... 12																																																																	
33	13 ... 18																																																																		
Metal																																																																			
Thermoplastic																																																																			
Thermoplastic																																																																			

Identification	Part number	Pg	Drawing	Dimensions in mm																																																																																																																	
Special cable clamp metal version with bell-mouth cable fitting and strain relief for standard hoods/housings  brass with strain relief  thermoplastic with bell-mouth cable fitting and strain relief 	09 00 000 5101	11	<table border="1"> <thead> <tr> <th>Style</th> <th>SW</th> <th>E</th> <th>a</th> <th>c</th> <th>d</th> <th>e</th> <th>f</th> </tr> </thead> <tbody> <tr> <td>Style A</td> <td>19</td> <td>23</td> <td>26.6</td> <td>M3</td> <td>6 ... 11</td> <td>9</td> <td></td> </tr> <tr> <td>Style B</td> <td>28</td> <td>31.5</td> <td>22</td> <td>M3</td> <td>9 ... 14</td> <td>6.5</td> <td></td> </tr> <tr> <td>Style B</td> <td>30</td> <td>33.5</td> <td>23</td> <td>M3</td> <td>10 ... 16</td> <td>6.5</td> <td></td> </tr> <tr> <td>Style A</td> <td>30</td> <td>37</td> <td>39.5</td> <td>M4</td> <td>13.5 ... 21</td> <td>12</td> <td></td> </tr> <tr> <td>Style A</td> <td>41</td> <td>50</td> <td>49</td> <td>M5</td> <td>19 ... 29</td> <td>13</td> <td></td> </tr> <tr> <td>Style C</td> <td>52</td> <td></td> <td>25.3</td> <td></td> <td>25 ... 31</td> <td>9.5</td> <td></td> </tr> <tr> <td>Style C</td> <td>59</td> <td></td> <td>26.3</td> <td></td> <td>31 ... 43</td> <td>10</td> <td></td> </tr> <tr> <td>Style D</td> <td>19</td> <td>33</td> <td>35</td> <td>M3</td> <td>6 ... 11</td> <td>9</td> <td>35</td> </tr> <tr> <td>Style D</td> <td>22</td> <td>36</td> <td>36.5</td> <td>M3</td> <td>7.5 ... 14</td> <td>10</td> <td>39</td> </tr> <tr> <td>Style D</td> <td>24</td> <td>38</td> <td>40</td> <td>M4</td> <td>10 ... 16</td> <td>10</td> <td>45</td> </tr> <tr> <td>Style D</td> <td>30</td> <td>46</td> <td>47.5</td> <td>M4</td> <td>12.5 ... 21</td> <td>12</td> <td>51</td> </tr> <tr> <td>Style D</td> <td>41</td> <td>60</td> <td>55.5</td> <td>M5</td> <td>17 ... 29</td> <td>13</td> <td>64</td> </tr> <tr> <td>Style D</td> <td>50</td> <td>76</td> <td>62</td> <td>M5</td> <td>20.5 ... 36</td> <td>13</td> <td>72</td> </tr> </tbody> </table> 	Style	SW	E	a	c	d	e	f	Style A	19	23	26.6	M3	6 ... 11	9		Style B	28	31.5	22	M3	9 ... 14	6.5		Style B	30	33.5	23	M3	10 ... 16	6.5		Style A	30	37	39.5	M4	13.5 ... 21	12		Style A	41	50	49	M5	19 ... 29	13		Style C	52		25.3		25 ... 31	9.5		Style C	59		26.3		31 ... 43	10		Style D	19	33	35	M3	6 ... 11	9	35	Style D	22	36	36.5	M3	7.5 ... 14	10	39	Style D	24	38	40	M4	10 ... 16	10	45	Style D	30	46	47.5	M4	12.5 ... 21	12	51	Style D	41	60	55.5	M5	17 ... 29	13	64	Style D	50	76	62	M5	20.5 ... 36	13	72	09 00 000 5102	13.5
	Style	SW		E	a	c	d	e	f																																																																																																												
	Style A	19		23	26.6	M3	6 ... 11	9																																																																																																													
	Style B	28		31.5	22	M3	9 ... 14	6.5																																																																																																													
	Style B	30		33.5	23	M3	10 ... 16	6.5																																																																																																													
	Style A	30		37	39.5	M4	13.5 ... 21	12																																																																																																													
	Style A	41		50	49	M5	19 ... 29	13																																																																																																													
	Style C	52			25.3		25 ... 31	9.5																																																																																																													
	Style C	59			26.3		31 ... 43	10																																																																																																													
	Style D	19		33	35	M3	6 ... 11	9	35																																																																																																												
	Style D	22		36	36.5	M3	7.5 ... 14	10	39																																																																																																												
	Style D	24		38	40	M4	10 ... 16	10	45																																																																																																												
	Style D	30		46	47.5	M4	12.5 ... 21	12	51																																																																																																												
	Style D	41		60	55.5	M5	17 ... 29	13	64																																																																																																												
	Style D	50		76	62	M5	20.5 ... 36	13	72																																																																																																												
	09 00 000 5103	16																																																																																																																			
	09 00 000 5104	21																																																																																																																			
	09 00 000 5106	29																																																																																																																			
09 00 000 5196	36																																																																																																																				
09 00 000 5197	42																																																																																																																				
09 00 000 5165	11																																																																																																																				
09 00 000 5166	13.5																																																																																																																				
09 00 000 5167	16																																																																																																																				
09 00 000 5168	21																																																																																																																				
09 00 000 5169	29																																																																																																																				
09 00 000 5170	36																																																																																																																				
Multiple seal 	09 00 000 5027	11	<table border="1"> <thead> <tr> <th>cable-Ø D</th> </tr> </thead> <tbody> <tr> <td>6.5 ... 12</td> </tr> <tr> <td>6.5 ... 13.5</td> </tr> <tr> <td>6.5 ... 16</td> </tr> <tr> <td>9 ... 20</td> </tr> <tr> <td>17 ... 28</td> </tr> <tr> <td>23 ... 34</td> </tr> </tbody> </table> 	cable-Ø D	6.5 ... 12	6.5 ... 13.5	6.5 ... 16	9 ... 20	17 ... 28	23 ... 34	09 00 000 5028	13.5																																																																																																									
	cable-Ø D																																																																																																																				
	6.5 ... 12																																																																																																																				
	6.5 ... 13.5																																																																																																																				
	6.5 ... 16																																																																																																																				
	9 ... 20																																																																																																																				
	17 ... 28																																																																																																																				
23 ... 34																																																																																																																					
09 00 000 5029	16																																																																																																																				
09 00 000 5030	21																																																																																																																				
09 00 000 5031	29																																																																																																																				
09 00 000 5032	36																																																																																																																				

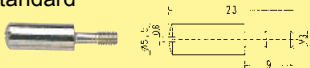
Identification	Part number	Pg	Drawing	Dimensions in mm																				
Cable gland (IP 65) Thermoplastic with normal seal 	grey 09 00 000 5164 black 09 00 000 5185	11 11	<table border="1"> <thead> <tr> <th>SW</th> <th> cable-Ø D</th> </tr> </thead> <tbody> <tr> <td>19</td> <td>10 ... 12</td> </tr> <tr> <td>19</td> <td>10 ... 12</td> </tr> </tbody> </table>	SW	cable-Ø D	19	10 ... 12	19	10 ... 12															
SW	cable-Ø D																							
19	10 ... 12																							
19	10 ... 12																							
Cable gland (IP 65) Metal with multiple seal 	09 00 000 5013 09 00 000 5014 09 00 000 5015 09 00 000 5016 09 00 000 5017 09 00 000 5018 09 00 000 5019	11 13.5 16 21 29 36 42	<table border="1"> <thead> <tr> <th>SW</th> <th> cable-Ø D</th> </tr> </thead> <tbody> <tr> <td>18</td> <td>6.5 ... 12</td> </tr> <tr> <td>20</td> <td>6.5 ... 13.5</td> </tr> <tr> <td>22</td> <td>6.5 ... 16</td> </tr> <tr> <td>28</td> <td>9 ... 20</td> </tr> <tr> <td>37</td> <td>17 ... 28</td> </tr> <tr> <td>47</td> <td>23 ... 34</td> </tr> <tr> <td>54</td> <td>29 ... 40</td> </tr> </tbody> </table>	SW	cable-Ø D	18	6.5 ... 12	20	6.5 ... 13.5	22	6.5 ... 16	28	9 ... 20	37	17 ... 28	47	23 ... 34	54	29 ... 40					
SW	cable-Ø D																							
18	6.5 ... 12																							
20	6.5 ... 13.5																							
22	6.5 ... 16																							
28	9 ... 20																							
37	17 ... 28																							
47	23 ... 34																							
54	29 ... 40																							
Increasers for Pg cable entries Metal 	09 00 000 5050 09 00 000 5051 09 00 000 5052 09 00 000 5053 09 00 000 5054 09 00 000 5055 09 00 000 5056	11 13.5 16 21 29 36 42	<table border="1"> <thead> <tr> <th>Pg1</th> </tr> </thead> <tbody> <tr> <td>11</td> </tr> <tr> <td>13.5</td> </tr> <tr> <td>16</td> </tr> <tr> <td>21</td> </tr> <tr> <td>29</td> </tr> <tr> <td>36</td> </tr> <tr> <td>42</td> </tr> <tr> <td>48</td> </tr> </tbody> </table>	Pg1	11	13.5	16	21	29	36	42	48												
Pg1																								
11																								
13.5																								
16																								
21																								
29																								
36																								
42																								
48																								
Reducers for Pg cable entries Metal 	09 00 000 5060 09 00 000 5061 09 00 000 5062 09 00 000 5063 09 00 000 5064 09 00 000 5065 09 00 000 5066 09 00 000 5067 09 00 000 5068	11 11 13.5 13.5 16 21 21 29 29	<table border="1"> <thead> <tr> <th>SW</th> <th>Pg1</th> </tr> </thead> <tbody> <tr> <td>20</td> <td>7</td> </tr> <tr> <td>20</td> <td>9</td> </tr> <tr> <td>22</td> <td>9</td> </tr> <tr> <td>22</td> <td>11</td> </tr> <tr> <td>24</td> <td>13.5</td> </tr> <tr> <td>30</td> <td>13.5</td> </tr> <tr> <td>30</td> <td>16</td> </tr> <tr> <td>40</td> <td>16</td> </tr> <tr> <td>40</td> <td>21</td> </tr> </tbody> </table>	SW	Pg1	20	7	20	9	22	9	22	11	24	13.5	30	13.5	30	16	40	16	40	21	
SW	Pg1																							
20	7																							
20	9																							
22	9																							
22	11																							
24	13.5																							
30	13.5																							
30	16																							
40	16																							
40	21																							
Blanking piece for Pg cable entries Metal 	09 00 000 5070 09 00 000 5071 09 00 000 5072 09 00 000 5073 09 00 000 5074 09 00 000 5075	11 13.5 16 21 29 36	<table border="1"> <thead> <tr> <th>SW</th> </tr> </thead> <tbody> <tr> <td>20</td> </tr> <tr> <td>22</td> </tr> <tr> <td>24</td> </tr> <tr> <td>30</td> </tr> <tr> <td>40</td> </tr> <tr> <td>50</td> </tr> </tbody> </table>	SW	20	22	24	30	40	50														
SW																								
20																								
22																								
24																								
30																								
40																								
50																								
Adapter Han® 3 A for motor connection 	09 20 000 9962	13.5		see also page 40.07																				

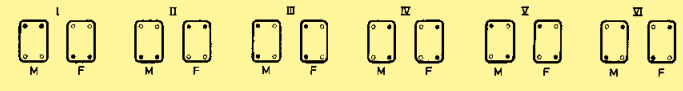
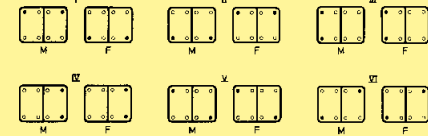
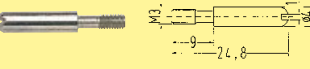
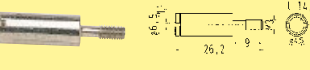
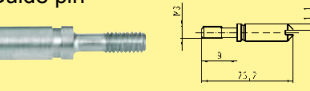
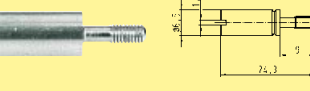
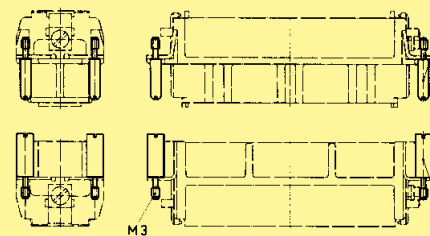
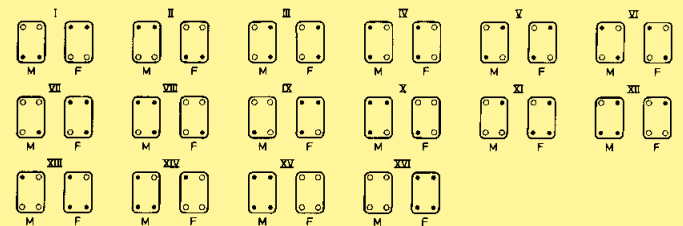
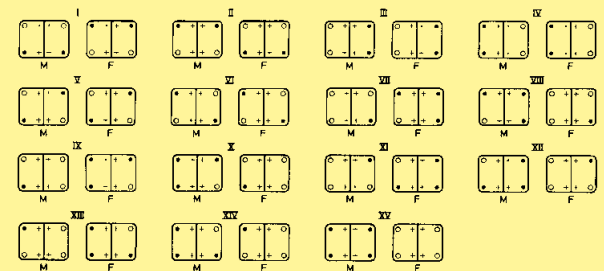
Stock items in bold type

Accessories

Identification	Part number	Drawing	Dimensions in mm
<p>Coding system with code pins</p> <p>standard </p> <p>Han-Modular® </p>	<p>09 30 000 9901¹⁾</p> <p>09 14 000 9901¹⁾</p>	<p>for hoods/housings with one insert/one frame</p>  <p>for hoods/housings with the inserts/two frames</p>  <p>• Code pin ○ Normal mounting screw</p> <p>M - Male insert F - Female insert</p>	
<p>Coding system with guide pins/bushes</p> <p>standard</p> <p>Guide pin </p> <p>Guide bushing </p> <p>Han-Modular®</p> <p>Guide pin </p> <p>Guide bushing </p>	<p>09 33 000 9908¹⁾</p> <p>09 33 000 9909¹⁾</p> <p>09 14 000 9908¹⁾</p> <p>09 14 000 9909¹⁾</p>	<p>This system is used to guard against angled coupling and decoupling of the connector. The maximum permitted angle according to DIN EN 175 301-801 is $\pm 5^\circ$ (longitudinally).</p>  <p>for hoods/housings with one insert/one frame</p>  <p>for hoods/housings with the inserts/two frames</p>  <p>• Guide pin ○ Bush + Normal mounting screw</p> <p>M - Male insert F - Female insert</p>	
<p>Coding pins</p> <p>for Han E®, Han® EE, Han® Q 5/0, Han® Q 8/0 </p> <p>for Han D®, Han DD® with loss of contact </p>	<p>09 33 000 9954</p> <p>09 33 000 9915</p>	<p>Use of the coding pin prevents incorrect mating to other connectors of the same type. The male pin should be omitted from the opposing cavity in the male insert.</p> 	

¹⁾ Order 4 pieces for one connector

Features

- 3 PE terminations
- Screws with ± head
- Self lifting washer
- Suitable for use with all inserts of the Han® 6 B to 24 B size (except Han® ESS-inserts)
- Suitable in hood high construction

Technical characteristics

Termination points	3
Termination wire gauge	0.5 ... 2.5 mm ²
- mm ²	AWG 20 ... 14
- AWG	
Material	copper alloy
Surface	nickel
Contact resistance	≤ 3 mΩ

Applications

The PE-multiple ground connection may be used to terminate three PE-wires on one connector.
Each PE-wire can be terminated and removed separately (acc. VDE 0113 DIN EN 60204 Pt. 14.1.1).

Features

- Suitable for all inserts of the series Han® B, Han E®, Han® ES, Han DD®, Han-Com® and Han-Modular®
- Ideal for applications in the field of transportation, as well as in the printing industry
- Due to the floating system of the docking frame the PE connection of the mounting base has to be installed separately
- Inserts are protected against mechanical damage

Technical characteristics

Material	
Docking frame	stainless steel
Fixing screws	steel, zinc-plated
Pull-in-range	
x-axis	± 1.5 mm
y-axis	± 1.5 mm
Mechanical working life	
- mating cycles	500



Identification

Han® Docking frame

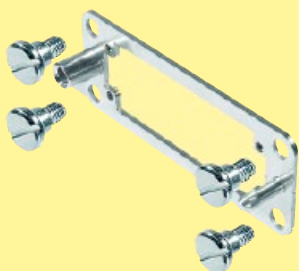

Size

Part number

Drawing

Dimensions in mm

6 B

09 30 006 1701

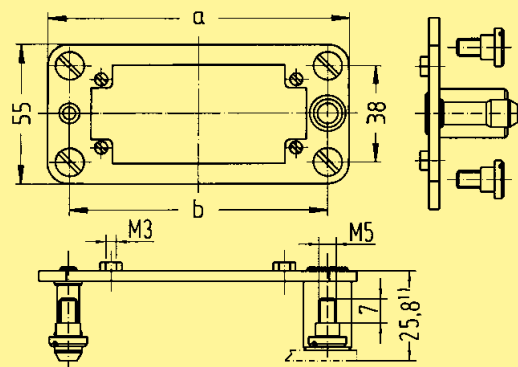

Distance for electrical and F.O. contacts max. 27 mm; for pneumatic contacts max. 26.5 mm

10 B

09 30 010 1701

16 B

09 30 016 1701

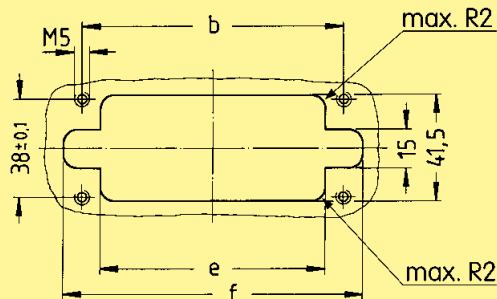

24 B

09 30 024 1701

Size	a	b	e	f
6 B	86	69	54.5	84
10 B	99	82	67.5	97
16 B	119.5	102.5	88	117.5
24 B	146	129	114.5	144

Range of delivery:

1 frame

4 cheese head shoulder screws to fix the docking frame

Features

- Grip frame suitable for Han® 64 D, Han® 108 DD, Han® 24 E/ES/ESS, Han® 46 EE
- Multiple shield connections via grip frame
- Cable can be fixed with clamps or cable tie

Technical characteristics

Grip frame	
Material	metal
Surface	8 µm Zn
Adapter	
Material	zinc die-cast
Surface	5 µm Ni over 8 µm Cu



Application

The grip frame can be used for termination of several shielded cables to be fixed on one connector.



Identification	Size	Part number	Drawing	Dimensions in mm
Ground terminal steel, zinc plated for Han E®, Han® EE and Han DD® in housings and hoods, high construction and Han-Snap®	6 B	09 00 000 5206		
	10 B	09 00 000 5207		
	16 B	09 00 000 5208		
	24 B	09 00 000 5210		
	24 B	09 00 000 5280		
Range of delivery: Ground terminal frame with M4 screws for fixing at insert				
PE terminal steel, zinc plated for Han-Modular® in housings bulkhead mounting and hoods high construction	24 B	09 00 000 5209		

Accessories

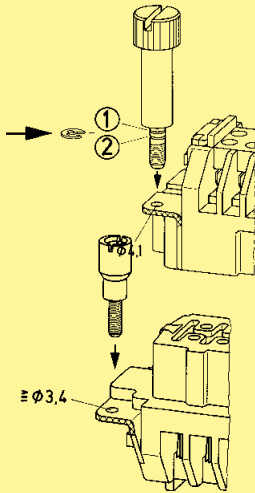
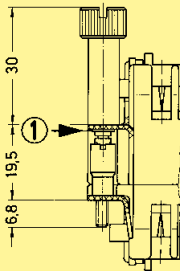
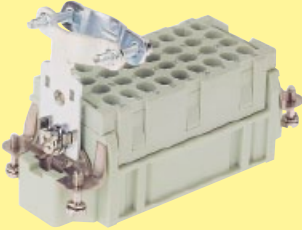
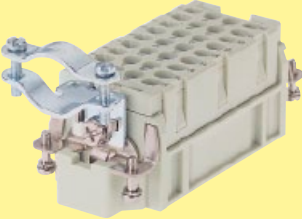
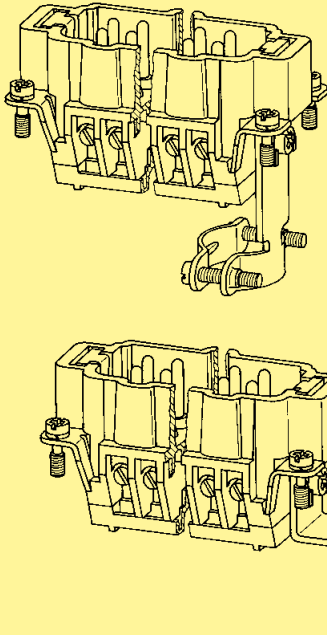

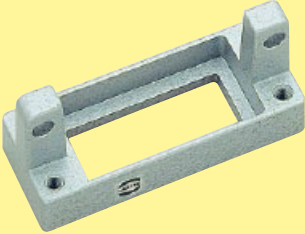
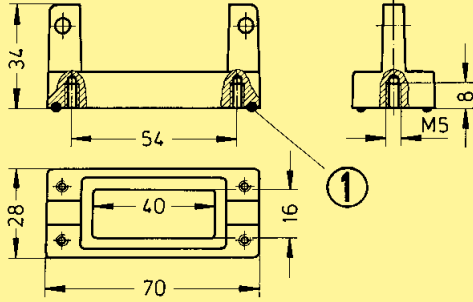
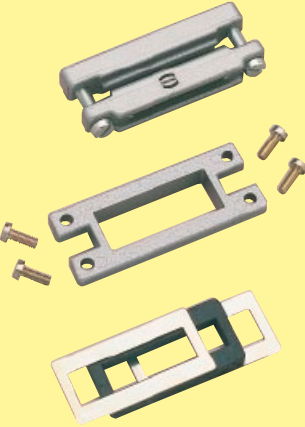
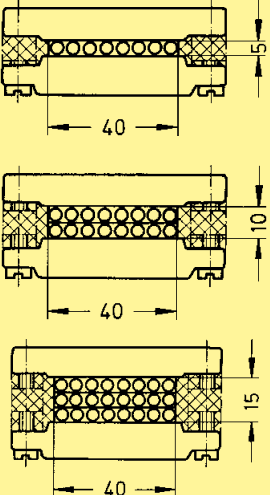

Identification	Part number	Drawing	Dimensions in mm			
<p>Clamps</p> <p>for ground terminals</p>	<p>09 00 000 5341</p> <p>09 00 000 5342</p>	<table border="1"> <thead> <tr> <th data-bbox="726 336 853 380">cable Ø</th> </tr> </thead> <tbody> <tr> <td data-bbox="726 380 853 593">5</td> </tr> <tr> <td data-bbox="726 593 853 828">10</td> </tr> </tbody> </table>	cable Ø	5	10	
cable Ø						
5						
10						
<p>Locking element with cord</p> <p>for Han® 10/16/24 B housings bulk-head mounting with Han-Easy Lock® double levers</p>  <p>for Han® 10/16/24 B with double metal levers</p>	<p>09 30 000 9986</p> <p>09 30 000 9987</p>		<p>① Length 120 mm</p>			

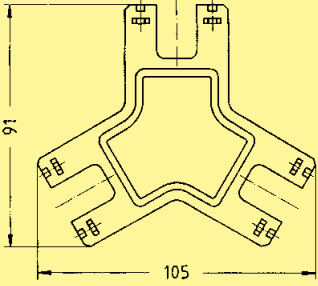
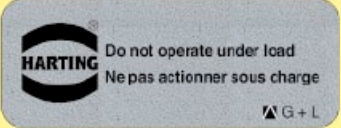





Identification	Part number	Drawing	Dimensions in mm
<p>Special insert fixing screws Screw pin</p>  <p>Bush</p> 	<p>09 33 000 9910¹⁾</p> <p>09 33 000 9912¹⁾</p>	 <p>Mounting example</p> 	<p>When using inserts without hoods or housings and requiring a locking facility this system is suitable for all rectangular connectors of the Han® series. For each connector we recommend two screw pins and two bushes as shown which are fitted diagonally to the inserts instead of the ordinary fixing screws. Holes for fixing to be drilled as shown.</p>
<p>Straight cable clamp fitting straight</p>  <p>angled</p>  <p>Range of delivery: Cable clamp fitting with 2 screws M3 Fixing screw M4 with washer</p>	<p>09 00 000 5340</p> <p>09 00 000 5339</p>	 <p>Clamping range of strain relief clamp: 9...19 mm</p>	<p>When using inserts without hoods or housings and requiring a strain relief this system is suitable for all rectangular connectors of series Han DD®, Han® 40-64 D, Han E® / Han® ES, Han® HsB, Han Hv E® / Han® Hv ES, Han® EE, Han® K 8/24. Fitted at the opposite end to the PE-termination.</p>

¹⁾ Order 2 pieces for one connector



Identification	Part number	Drawing	Dimensions in mm
<p>Bracket for flat cable for separate mounting</p> 	<p>09 00 000 5325</p>	 <p>① O-Ring seal</p>	
<p>Set of seals with strain relief clamp</p> 	<p>09 00 000 5315 for 1 flat cable</p> <p>09 00 000 5316 for 2 flat cables</p> <p>09 00 000 5317 for 3 flat cables</p>		
<p>Frame for custom test adapters</p> <p>Mounting example</p> 	<p>09 38 000 9901</p>		
<p>Label according to CSA-approval</p> 	<p>09 30 000 9958</p>	<p>When supplying connectors for use at more than 30 V subject to CSA-approval we recommend that the label is fixed in close proximity to the installed connectors. Dimensions: 56 x 18 mm Part No. comprises 50 labels per sheet.</p>	

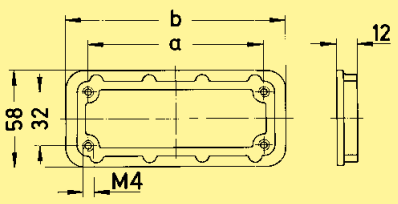

Accessories

Identification		Size	Part number	Drawing	Dimensions in mm
Contact screw for Han® 3 A, 4 A, Staf®, for PE in Han® Q 5/0, Q 7/0		M3	09 30 000 9997		
PE screw for Han A®, Han® 15, 25 D for Han E® etc. for Han-Com®, Han® HsB for Han-Modular® hinged frames		M3.5 M4 M5 M3 M4	09 20 000 9919 09 33 000 9925 09 33 000 9926 09 14 000 9953 09 14 000 9954		
Fixing screws standard for Han® 3 A for Han® 3 A IP 65/67 for Han-Compact®		M3 M3 M3 ST 2.9x9.5 F-H	09 16 000 9903 09 20 000 9995 09 20 000 9918 09 12 000 9921		
Locking screw for Han® HPR for Han® 6/10/16/24 HPR for Han® 3 A for Han® 48 HPR		M6 M4 M6	09 40 000 9932 09 40 000 9929 09 40 000 9937		
Toggle locking screw for Han® HPR for Han® 6/10/16/24 HPR for Han® 3 HPR		-	09 40 000 9931 09 40 000 9933		

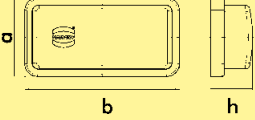
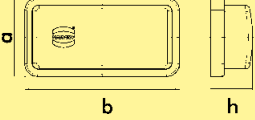

Identification	Size	Part number	Drawing	Dimensions in mm															
Locking levers Thermoplastic for Han® 3 A 	3 A	grey 09 00 000 5241																	
	3 A	black 09 00 000 5242																	
Han-Easy Lock® single levers 	10 A	09 00 000 5224																	
	16 A	09 00 000 5225																	
	6 B	09 00 000 5222																	
	10 B	09 00 000 5228																	
	16 B	09 00 000 5229																	
	24 B	09 00 000 5230																	
Han-Easy Lock® double levers 	10/16/ 24 B	09 00 000 5221																	
	32 A	09 00 000 5223																	
	32 B	09 00 000 5231																	
Mounting frames for standard hoods/housings 	6 B	09 40 000 9921	 <table border="1"> <thead> <tr> <th>Size</th> <th>a</th> <th>b</th> </tr> </thead> <tbody> <tr> <td>6 B</td> <td>70</td> <td>96</td> </tr> <tr> <td>10 B</td> <td>83</td> <td>109</td> </tr> <tr> <td>16 B</td> <td>103</td> <td>129</td> </tr> <tr> <td>24 B</td> <td>130</td> <td>156</td> </tr> </tbody> </table>	Size	a	b	6 B	70	96	10 B	83	109	16 B	103	129	24 B	130	156	
Size	a	b																	
6 B	70	96																	
10 B	83	109																	
16 B	103	129																	
24 B	130	156																	
	10 B	09 40 000 9922																	
	16 B	09 40 000 9923																	
	24 B	09 40 000 9924																	
Bearing pedestal for Han® 10 A, 16 A, 32 A, 6 B, 10 B, 16 B, 24 B 	-	09 30 000 9964																	

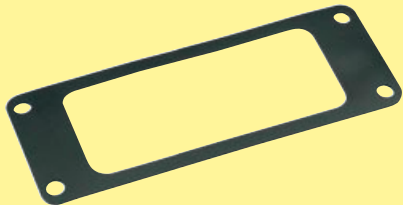
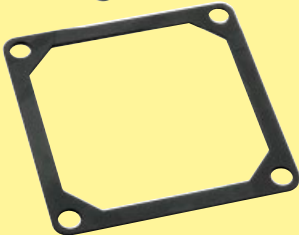
Accessories

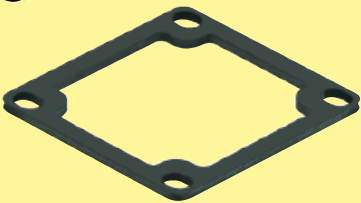
Identification	Size	Part number	Drawing	Dimensions in mm																																				
Cover for bearing pedestal Metal 	6 B	09 30 006 5403																																						
	10 B	09 30 010 5404																																						
	16 B	09 30 016 5404																																						
	24 B	09 30 024 5404																																						
	Thermoplastic 	10 A			09 20 010 5410																																			
		16 A			09 20 016 5410																																			
		6 B			09 30 006 5410																																			
		10 B			09 30 010 5410																																			
		16 B			09 30 016 5410																																			
		24 B			09 30 024 5410																																			
Dust protection cover for Han® B housings 	10 B	09 30 010 5406		<table border="1"> <thead> <tr> <th>Size</th> <th>a</th> <th>b</th> <th>h</th> </tr> </thead> <tbody> <tr> <td>10 B</td> <td>45.2</td> <td>74.8</td> <td>18</td> </tr> <tr> <td>16 B</td> <td>45.2</td> <td>95.3</td> <td>18</td> </tr> <tr> <td>24 B</td> <td>45.2</td> <td>121.8</td> <td>18</td> </tr> <tr> <td>3 A</td> <td>27.8</td> <td>45.7</td> <td>12.5</td> </tr> <tr> <td>6 B</td> <td>55</td> <td>93.2</td> <td>29</td> </tr> <tr> <td>10 B</td> <td>55</td> <td>106.2</td> <td>29</td> </tr> <tr> <td>16 B</td> <td>55</td> <td>126.2</td> <td>29</td> </tr> <tr> <td>24 B</td> <td>55</td> <td>153.2</td> <td>29</td> </tr> </tbody> </table>	Size	a	b	h	10 B	45.2	74.8	18	16 B	45.2	95.3	18	24 B	45.2	121.8	18	3 A	27.8	45.7	12.5	6 B	55	93.2	29	10 B	55	106.2	29	16 B	55	126.2	29	24 B	55	153.2	29
	Size	a			b	h																																		
	10 B	45.2			74.8	18																																		
	16 B	45.2			95.3	18																																		
	24 B	45.2			121.8	18																																		
	3 A	27.8			45.7	12.5																																		
	6 B	55			93.2	29																																		
	10 B	55			106.2	29																																		
	16 B	55			126.2	29																																		
	24 B	55			153.2	29																																		
16 B	09 30 016 5406																																							
24 B	09 30 024 5406																																							
for Han® HPR housings 	3 A	09 40 003 5406																																						
	6 B	09 40 006 5406																																						
	10 B	09 40 010 5406																																						
	16 B	09 40 016 5406																																						
	24 B	09 40 024 5406																																						

Identification	Size	Material NBR	Material FPM
L-seal for hoods cable to cable 	6 B	09 30 000 9936	
	10 B	09 30 000 9935	
	16 B	09 30 000 9934	
	24 B	09 30 000 9933	
Gasket    	Modular Compact	09 14 000 9940	
	3 A	09 20 000 9991	09 37 000 9912
	10 A	09 20 000 9992	
	16 A	09 20 000 9993	
	32 A	09 20 000 9994	
	Han-Drive®	09 30 000 9903	
	6 B	09 30 000 9801	09 37 000 9946
	10 B	09 30 000 9802	09 37 000 9947
	16 B	09 30 000 9803	09 37 000 9948
	24 B	09 30 000 9804	09 37 000 9949
	48 B	09 30 000 9996	
	3 HPR	09 40 000 9980	

Accessories

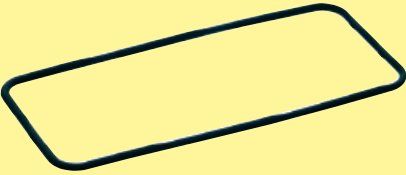
Identification	Size	Material NBR	Material FPM
L-seal for hoods cable to cable 	6 B	09 30 000 9936	
	10 B	09 30 000 9935	
	16 B	09 30 000 9934	
	24 B	09 30 000 9933	
Profile seal 	3 A	09 70 000 9991	09 21 000 9906
	10 A	09 20 000 9996	
	16 A	09 20 000 9997	
	6 B	09 30 000 9941	
	10 B	09 30 000 9942	
	16 B	09 30 000 9943	
	24 B	09 30 000 9944	
	48 B	09 30 000 9995	
O-ring-sealing for Han® HPR 	3 HPR	09 40 000 9910	
	6 HPR	09 40 000 9911	
	10 HPR	09 40 000 9912	
	16 HPR	09 40 000 9913	
	24 HPR	09 40 000 9914	

