

ULTRA RT5/6 and RT6 Gimbal LED



Recessed Downlight Kit



The SYLVANIA ULTRA RT5/6 is a 5" and 6" compatible LED recessed downlight kit creating high performing white light and is optimized for new construction and retrofit applications. Installation is done quickly and easily in most standard 5" or 6" Insulated Ceiling (IC) housings, Airtight (AT) housings and non-IC housings. The adjustable gimbal features a smooth travel from nadir to a 30° tilt, making it suitable for slanted ceilings and wall wash. The gimbal's friction blade design allows the downlight to be installed in any position within the housing aperture and the 360° horizontal rotation capability of the gimbal head offers easy aiming and adjustment.

Dimming

The SYLVANIA ULTRA RT Series recessed downlight kits are dimmable to 10% with standard 120V electronic low voltage dimmers (recommended), incandescent or magnetic low voltage dimmers. In some cases, standard incandescent dimmers require a minimum load of typically >40 watts on the circuit for full range dimming performance (four LED modules). For dimming with digital (smart) multi-location dimmers or when dimming fewer than four LED modules, electronic low-voltage (ELV) dimmers are required (some ELV dimmers need a neutral connection in the wallbox).

Application Information

Applications

- Healthcare
- Hospitality
- Office
- Property Management
- Residential
- Retail

Key Features & Benefits

- Lumen package:
 - 700 lumens
 - 900 lumens
 - 1200 lumens
- Replacement for up to 100W incandescent lamps
- RT5/6 fits into most 5" and 6" recessed downlight fixtures
- CCT: 2700K/3000K/4000K/5000K
- CRI: 90 and >80 CRI option
- Beam angle: 80°
- Dimmable down to 10%
- 50,000 hour life (L₇₀)
- Suitable for indoor and outdoor dry, damp and wet locations (Only applies to non-Gimbal types)
- Reduces energy consumption up to 84%
- 120V input voltage
- Lasts up to 25 times longer than incandescent lamps
- No warm-up time, instant-on with full light output and stable lamp to lamp color
- CEC compliant product meets California Title 24 fixture requirements for high efficacy luminaire
- Integrated white trim, white baffle reflector socket adaptor (included) for direct replacement
- Adjustable Gimbal feature (30° tilt and 360° rotation)

Quality of Light

The SYLVANIA ULTRA RT Series provides excellent color rendering (82+ and 90 CRI option), and a selection of color temperatures (2700K, 3000K, 4000K and 5000K). LEDs have virtually no UV or infrared radiation to damage or fade furnishings, art or other objects.

Optical Design

Optical design efficiently directs light output in an 80° beam angle with low glare.

Accessories

Assorted color retrofit trims, GU24 socket adaptor, push wire adaptor, retrofit band.

Product Offering

Lumen Output	Wattage	Color Temperature	CRI
700	10	2700K, 3000K, 4000K, 5000K	Up to 84
700	12	2700K, 3000K, 4000K	90
900	13	2700K, 3000K	Up to 84
1200	16	2700K, 3000K, 4000K	82

Specifications and Certifications



Specification Data

Catalog #	Type
Project	
Comments	
Prepared by	

Specifications

Energy Data

Minimum Starting Temp: -40°F (-40°C)
EMI/RFI: FCC Title 47 CFR, Part 15, Class B
Sound Rating: <24dBA
Input Voltage: 120V
Power Factor: >0.90
Input Frequency: 60Hz

THD: <20%

Input Power: 10W, 12W, 13W & 16W

Input Current: 0.08A & 0.1A

Maximum Ambient Operating Temperature (Insulated Ceiling or Non-Insulated Ceiling): 104°F (40°C)

Lighting Data

Lumen Output: 700, 900 & 1200

Color

Correlated Color Temperature (CCT): 2700K, 3000K, 4000K, 5000K

Color Rendering Index (CRI): Up to 90

Ordering Information

Item Number	Ordering Abbreviation	Recessed Housing	Replaced Incandescent Wattage	Nominal Wattage (W)	Delivered Light Output (lm)	Color Temperature	CRI	R9	Avg. Rated Life (hrs)*
73394	LED/RT/5/6/700/827/FL80	5 in. and 6 in.	65W	10	700	2700K	84	15	50,000
71707	LED/RT6/700/830/FL80	6 in.	65W	10	700	3000K	84	15	50,000
73395	LED/RT5/6/700/830/FL80	5 in. and 6 in.	65W	10	700	3000K	84	15	50,000
73157	LED/RT/5/6/700/840/FL80	5 in. and 6 in.	65W	10	700	4000K	83	15	50,000
73159	LED/RT/5/6/700/850/FL80	5 in. and 6 in.	65W	10	700	5000K	83	15	50,000
72578	LED/RT5/6/700/927/FL80/CEC**	5 in. and 6 in.	65W	12	700	2700K	90	50	50,000
72579	LED/RT5/6/700/930/FL80/CEC**	5 in. and 6 in.	65W	12	700	3000K	90	50	50,000
72593	LED/RT5/6/700/940/FL80/CEC**	5 in. and 6 in.	65W	12	700	4000K	90	50	50,000
73396	LED/RT/5/6/900/827/FL80	5 in. and 6 in.	75W	13	900	2700K	82	15	50,000
73397	LED/RT/5/6/900/830/FL80	5 in. and 6 in.	75W	13	900	3000K	84	15	50,000
73466	LED/RT/5/6/G/900/827/FL80RP	5 in. and 6 in.	75W	13	900	2700K	84	15	50,000
73467	LED/RT/5/6/G/900/830	5 in. and 6 in.	75W	13	900	3000K	84	15	50,000
73498	LED/RT/5/6/1200/827	5 in. and 6 in.	100W	16	1200	2700K	82	15	50,000
73499	LED/RT/5/6/1200/830	5 in. and 6 in.	100W	16	1200	3000K	82	15	50,000
73500	LED/RT5/6/1200/840	5 in. and 6 in.	100W	16	1200	4000K	82	15	50,000

* LED lamp life is defined as the number of hours when 50% of an average group of identical lamps reached 70% of its initial lumens.

** Ships with GU24 base, medium base adaptor sold separately.

Ordering Guide

LED	RT6	G	900	8	30	CEC
LED	Product Name: RT6 6=fits 6" housing 5/6=fits 5" and 6" housing	Gimbal	Light Output 900 lm	CRI >80	Color Temperature 3000K	CEC compliant, ships with a GU24 base

Energy Savings

Basic Product Description	LED Lumens	LED Life	Traditional Lamp Types	Lumens	Life	Watts Saved With RT6	RT6 Energy Savings*	RT6 Life Benefit
RT5/6 10W	700	50,000	Incandescent 65WBR30	640	2000	55	\$302	25X
RT5/6 13W	900	50,000	Incandescent 75WBR40	935	2000	62	\$341	25X
RT5/6 16W	1200	50,000	Incandescent 100WBR40	1,600	2000	84	\$462	25X

* Based on \$0.11/kWh over 50,000 hours life.

Application Information

Application Notes

- Operating temperature range between -40°F and 104°F (-40°C and 40°C).
- Suitable for indoor and outdoor dry, damp and wet locations (Both Gimbal and non-Gimbal).
- Suitable for dimmers or in housings controlled by a dimmer. For a list of compatible dimmers, please refer to www.sylvania.com/RT6.
- Not intended for use with emergency light fixtures or exit lights.
- For use in housings that can structurally support a lamp weighing one pound.
- RT5/6 designed to install in standard 5" and 6" insulated and non-insulated housings.
- RT6 designed to install in standard 6" insulated and non-insulated housings. For a list of compatible housings, please refer to www.sylvania.com/RT6.
- For detailed warranty information, please refer to www.sylvania.com/RT6.

Assembly Diagram

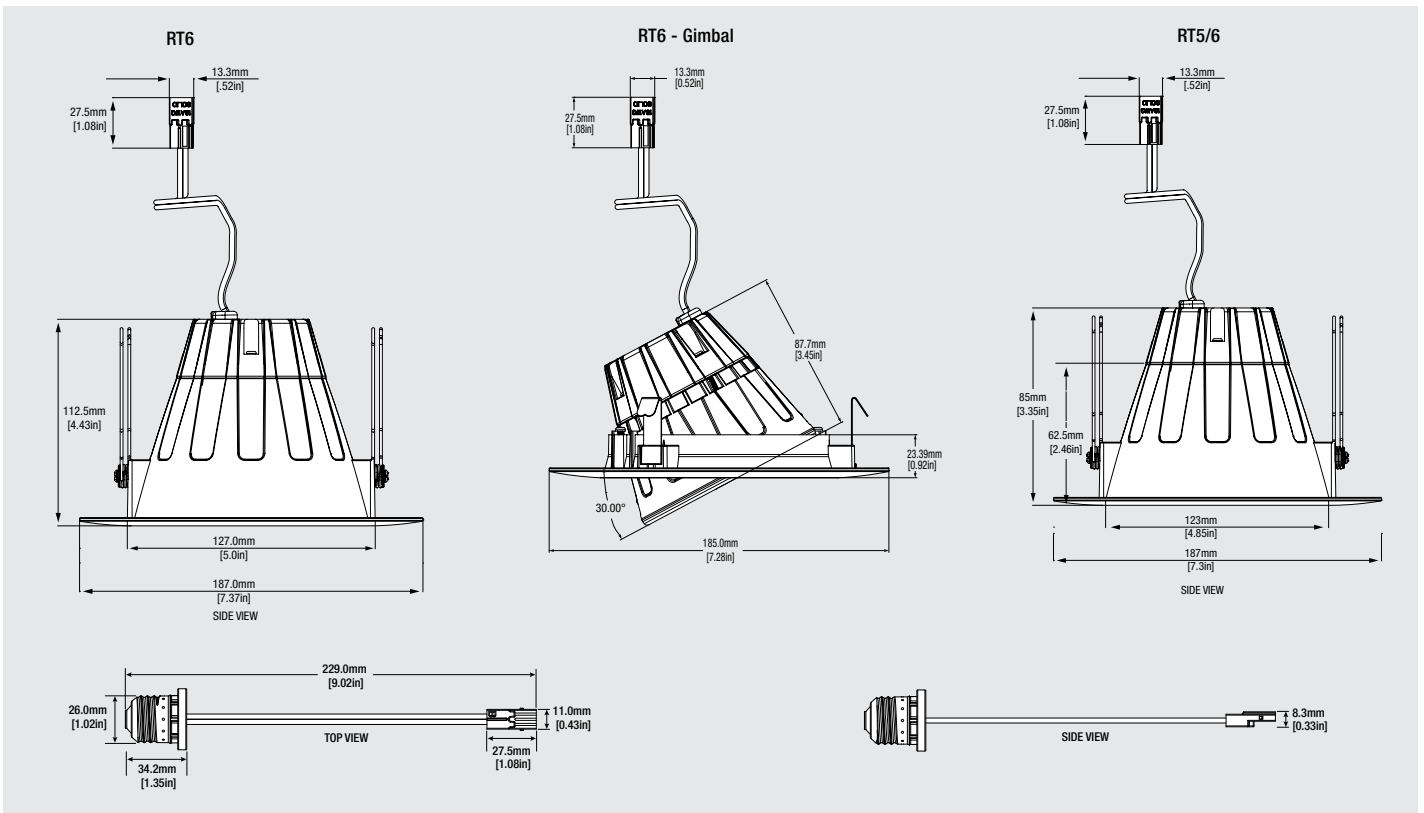

Accessories

Socket Adaptor

- 75105 LED/ADAPTOR/GU24 (sold separately)
- 75096 LED/ADAPTOR/MEDBASE (sold separately)

Push Wire Adaptor

- 75107 LED/ADAPTOR/PUSHWIRE (sold separately)

Retrofit Band (For 6" housing models Progress Lighting P87-AT and Lightolier 1104IC)

- 70663 RT6/RETROFITBAND (sold separately)

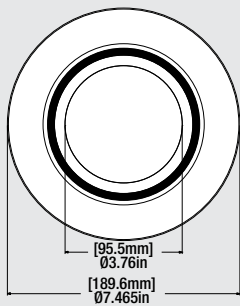
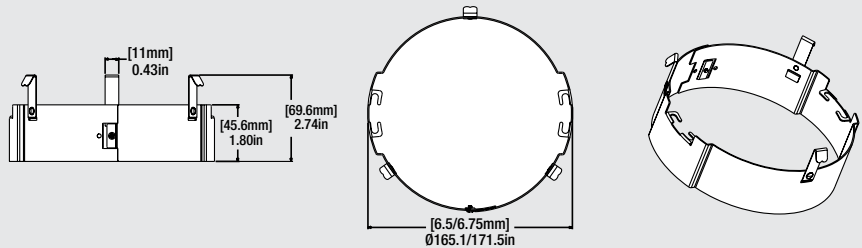

RT6 Retrofit Trim (For non-Gimbal RT6 only, can not be used with Gimbal or with RT5/6)

- | | | |
|-------|--------------------|--|
| 70709 | RT6/TRIM/ORBZ | One Tone: Bronze Trim & Bronze Reflector |
| 70710 | RT6/TRIM/SN | One Tone: Satin Nickel Trim & Satin Nickel Reflector |
| 75108 | RT6/TRIM/DKBZ | One Tone: Dark Bronze Trim & Dark Bronze Reflector |
| 70711 | RT6/TRIM/BLKBAFFLE | Two Tone: White Trim & Black Baffle Reflector |
| 70712 | RT6/TRIM/WHTBAFFLE | Two Tone: White Trim & White Baffle Reflector |
| 70715 | RT6/TRIM/ALZAK | Two Tone: White Trim & Alzak Reflector |

RT5/6 Retrofit Trim (For non-Gimbal only, can be used with RT5/6 and RT6)

- | | |
|-------|------------------|
| 75095 | RT/5/6/TRIM/DKBZ |
| 75097 | RT/5/6/TRIM/BLK |
| 75098 | RT/5/6/TRIM/ORBZ |
| 75099 | RT/5/6/TRIM/SN |

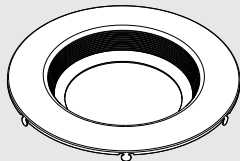

75097



70709/75098



70712



70711



70710/75099



70715

Photometric Information

ULTRA RT6 700

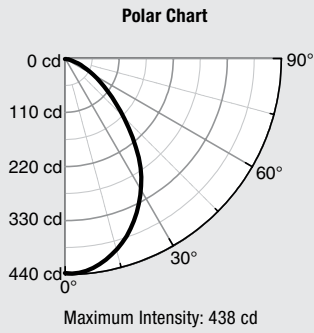

Illuminance at Distance

Distance (ft)	Illuminance		Beam Diameter	
	Edge	Center	V	H
2 ft	26.0 fc	109.5 fc	3.2 ft	3.2 ft
4 ft	6.5 fc	27.4 fc	6.4 ft	6.4 ft
6 ft	2.9 fc	12.2 fc	9.6 ft	9.6 ft
8 ft	1.6 fc	6.8 fc	12.8 ft	12.3 ft
10 ft	1.0 fc	4.4 fc	16.1 ft	16.1 ft
12 ft	0.7 fc	3.0 fc	19.3 ft	19.3 ft

Vert. Spread: 77.6° Horiz. Spread: 77.5°

Zonal Lumen Distribution

Zone	Lumens	% Fixture
0-30	305.6	41.3
0-40	462.6	62.5
0-60	668.3	90.3
60-90	71.5	9.7
0-90	739.8	100.0
90-180	0.0	0.0
0-180	739.8	100.0

Spacing to Mounting Height Ratio

Spacing Criteria (0-180°)	1.04
Spacing Criteria (90-270°)	1.08
Spacing Criteria (Diagonal)	1.12

ULTRA RT6 900

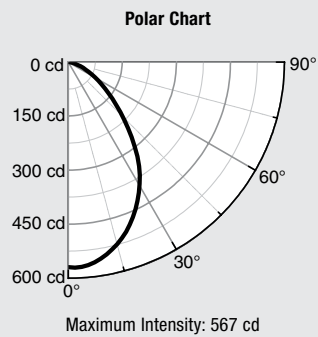

Illuminance at Distance

Distance (ft)	Illuminance		Beam Diameter	
	Edge	Center	V	H
2 ft	35.0 fc	141.8 fc	3.1 ft	3.1 ft
4 ft	8.8 fc	35.4 fc	6.2 ft	6.1 ft
6 ft	3.9 fc	15.8 fc	9.3 ft	9.2 ft
8 ft	2.2 fc	8.9 fc	12.4 ft	12.3 ft
10 ft	1.4 fc	5.7 fc	15.5 ft	15.4 ft
12 ft	1.0 fc	3.9 fc	18.6 ft	18.4 ft

Vert. Spread: 75.5° Horiz. Spread: 75.1°

Zonal Lumen Distribution

Zone	Lumens	% Fixture
0-30	393.6	43.2
0-40	589.4	64.7
0-60	828.9	91.0
60-90	81.7	9.0
0-90	910.6	100.0
90-180	0.0	0.0
0-180	910.6	100.0

Spacing to Mounting Height Ratio

Spacing Criteria (0-180°)	1.02
Spacing Criteria (90-270°)	1.04
Spacing Criteria (Diagonal)	1.10

ULTRA RT6 1200

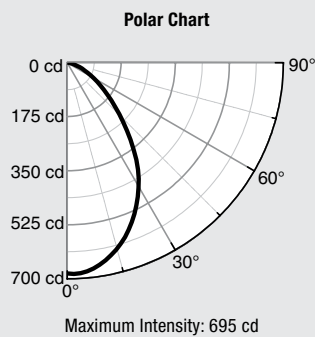

Illuminance at Distance

Distance (ft)	Illuminance		Beam Diameter	
	Edge	Center	V	H
2 ft	38.4 fc	171 fc	3.4 ft	3.4 ft
4 ft	9.6 fc	42.8 fc	6.7 ft	6.7 ft
6 ft	4.3 fc	19 fc	10.4 ft	10.4 ft
8 ft	2.4 fc	10.7 fc	13.4 ft	13.4 ft
10 ft	1.5 fc	6.8 fc	16.8 ft	16.8 ft
12 ft	1.1 fc	4.8 fc	20.1 ft	20.1 ft

Zonal Lumen Distribution

Zone	Lumens	% Fixture
0-30	503.0	39.0
0-40	61.0	61.0
0-60	1163.0	91.0
0-90	1275.0	100.0
90-180	0.0	0.0
0-180	1275.0	100.0

Spacing to Mounting Height Ratio

Spacing Criteria (0-180°)	1.14
Spacing Criteria (90-270°)	1.14
Spacing Criteria (Diagonal)	1.18

OSRAM

Americas Headquarters

OSRAM SYLVANIA Inc.

100 Endicott Street

Danvers, MA 01923 USA

Phone 1-800-LIGHTBULB (1-800-544-4828)

www.sylvania.com

SYLVANIA is a registered trademark of OSRAM SYLVANIA Inc.
ENERGY STAR is a registered trademark of the U.S. Government.
Specifications subject to change without notice.

