

**PLEASE CHECK WWW.MOLEX.COM FOR LATEST PART INFORMATION**

**Part Number:** [0003061092](#)  
**Status:** **Active**  
**Overview:** Standard .062" Pin and Socket Power Connectors  
**Description:** 1.57mm Diameter Standard .062" Pin and Socket Receptacle Housing, 9 Circuits, without Mounting Ears

**Documents:**

[3D Model](#) [Packaging Specification PK-1625-003-001 \(PDF\)](#)  
[Drawing \(PDF\)](#) [RoHS Certificate of Compliance \(PDF\)](#)  
[Product Specification PS-02-06-001 \(PDF\)](#)

**Agency Certification**

CSA LR19980  
 UL E29179

**General**

Product Family Crimp Housings  
 Series [1625](#)  
 Application Power, Wire-to-Wire  
 Comments Polarized to Mating Part  
 Overview [Standard .062" Pin and Socket Power Connectors](#)  
 Product Name Standard .062"  
 UPC 800753615571

**Physical**

Breakaway No  
 Circuits (maximum) 9  
 Circuits Detail 3x3  
 Color - Resin Natural  
 Flammability 94V-2  
 Gender Receptacle  
 Glow-Wire Compliant No  
 Keying to Mating Part None  
 Lock to Mating Part Yes  
 Material - Resin Nylon  
 Net Weight 2.194/g  
 Number of Rows 3  
 Packaging Type Bag  
 Panel Mount No  
 Pitch - Mating Interface 3.68mm  
 Pitch - Termination Interface 3.68mm  
 Polarized to Mating Part Yes  
 Stackable No  
 Temperature Range - Operating -40°C to +105°C

**Electrical**

Current - Maximum per Contact 5.0A

**Solder Process Data**

Lead-freeProcess Capability N/A

**Material Info**

Engineering Number 1625-9R1

**Reference - Drawing Numbers**

Packaging Specification PK-1625-003-001  
 Product Specification PS-02-06-001  
 Sales Drawing SD-1625-9\*

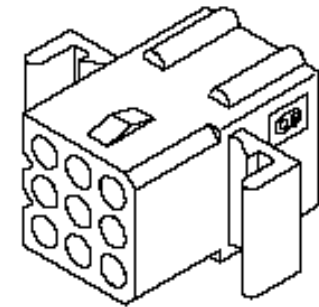

Series image - Reference only

**EU ELV**

**Not Relevant**

**EU RoHS**

**Compliant**

**REACH SVHC**

Not Contained Per  
 -ED/01/2017 (12  
 January 2017)

**Halogen-Free**

**Status**

**Low-Halogen**

**Need more information on product environmental compliance?**

Email [productcompliance@molex.com](mailto:productcompliance@molex.com)  
 Please visit the [Contact Us](#) section for any non-product compliance questions.

China ROHS Green Image  
 ELV Not Relevant  
 RoHS Phthalates Not Contained

**Search Parts in this Series**

[1625 Series](#)

**Mates With**

[03-06-2091](#) , [03-06-2092](#)

**Use With**

Female Crimp Terminals [1561](#) , [4559](#) , [4529](#) , [2190](#) , [2189](#) , [1787](#) , [1855](#) . Male Crimp Terminals [1560](#) , [1786](#) , [1854](#) . [1778](#) Male PC Tail Terminals. [1779](#) Female PC Tail Terminals

This document was generated on 04/19/2017

**PLEASE CHECK [WWW.MOLEX.COM](http://WWW.MOLEX.COM) FOR LATEST PART INFORMATION**