

ISM 868 MHz Ceramic Antenna

Ground cleared under antenna, clearance area 10.80 mm x 8.25 mm. Pulse Part Number: W3013

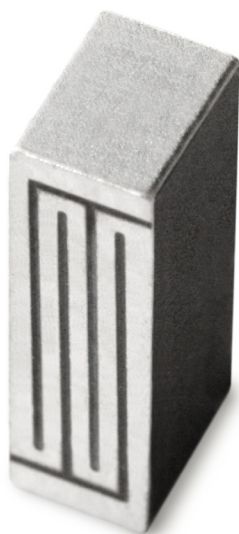

Features

- Omni directional radiation
- Low profile
- Compact size W x L x H (10 x 3.2 x 4 mm)
- Low weight (600 mg)
- Lead free materials
- Fully SMD compatible
- Lead free soldering compatible
- Tape and reel packing
- RoHS Compliant Product

Applications

- ISM 868 Band

Electrical specifications @ +25 °C

Note: Electrical characteristics depend on test board (GP) size and antenna positioning on GP and Ground Clearance area size.

ISM 868 – 870 MHz

Typical performance (test board size 100 x 37 mm, PWB ground clearance area 10.80 mm x 8.25)

Frequency Range [MHz]	Linear Max Gain [dBi]	Efficiency [%] / [dB]	Return loss min. [dB]	Impedance [Ω]	Operating Temperature [°C]
868 – 870	1.4 (Peak) 1.4 (Band edges)	65 / -1,9 (peak) 65 / -1,9 (band edges)	-10	50	-40 to +85

Pulse Finland Oy

Takatie 6
90440 Kempele, Finland
Tel: +358 207 935 500
Fax: +358 207 935 501

www.pulseeng.com/antennas



ISM 868 MHz Ceramic Antenna

Ground cleared under antenna, clearance area 10.80 mm x 8.25 mm. Pulse Part Number: W3013

Terminal Configuration

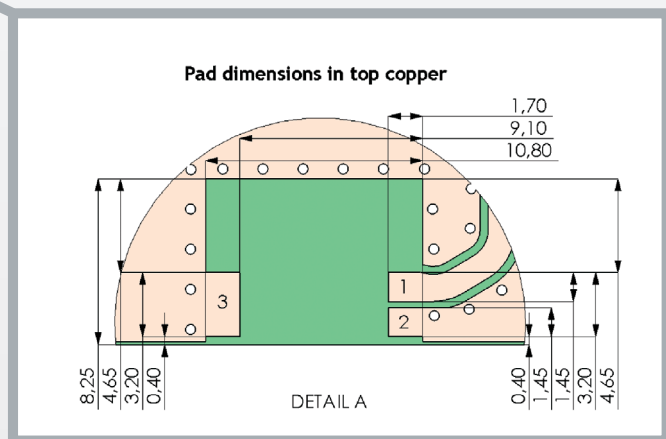
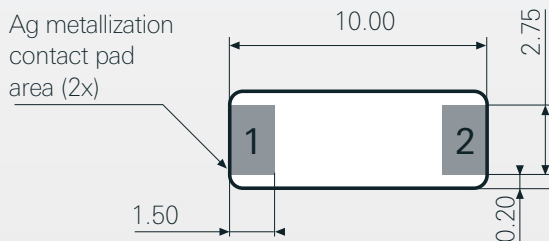
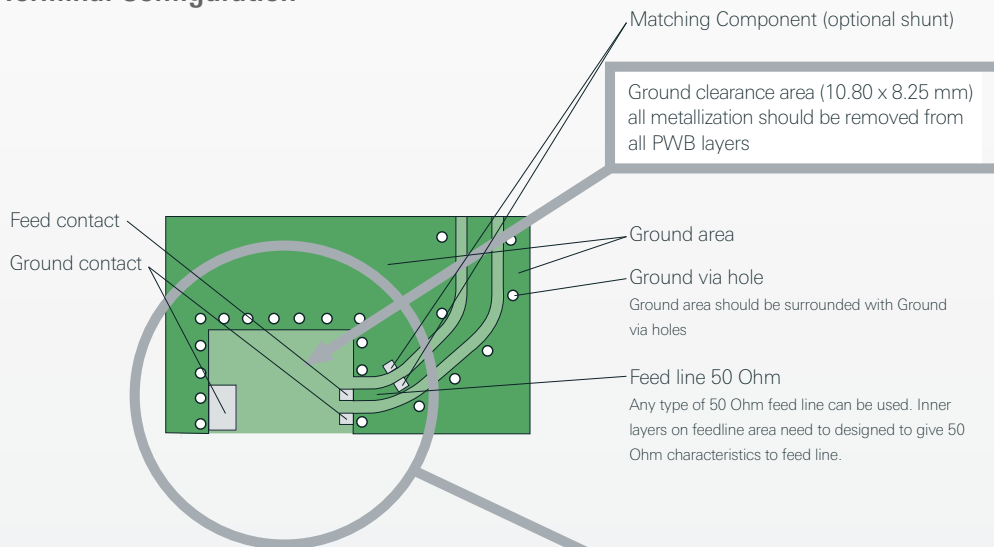

Antenna features

No.	Terminal name	Terminal Dimensions
1	Feed / GND	1.5 x 2.75 mm
2	Feed / GND	1.5 x 2.75 mm

Antenna is symmetrical.
Either of terminals 1 or 2 can be feed / GND

PWB features

No.	Terminal name	Terminal Dimensions
1	Feed	1,7 x 1,45 mm
2	GND	1,7 x 1,45 mm
3	GND	1,7 x 3,20 mm

Pulse Finland Oy

Takatie 6
90440 Kempele, Finland
Tel: +358 207 935 500
Fax: +358 207 935 501
www.pulseeng.com/antennas



ISM 868 MHz Ceramic Antenna

Ground cleared under antenna, clearance area 10.80 mm x 8.25 mm. Pulse Part Number: W3013

Typical Electrical Characteristics (T=25 °C)

Measured on the 100 x 37mm test board with 8.2 pF matching capacitor.

Typical Return Loss S11/ impedance

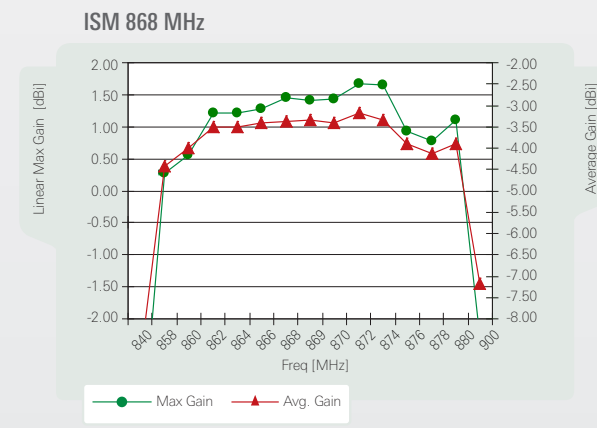
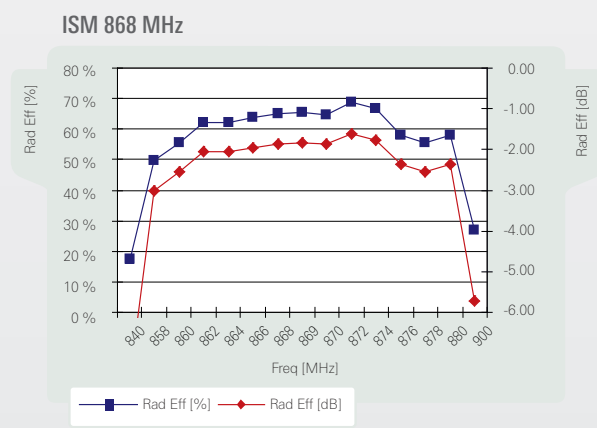
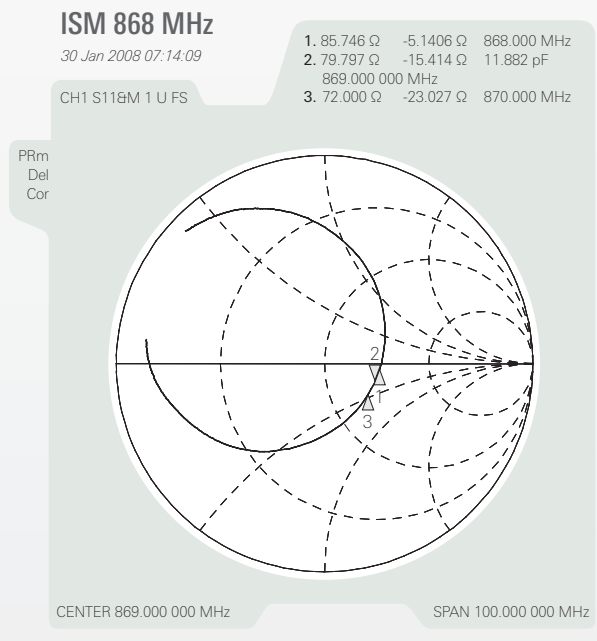
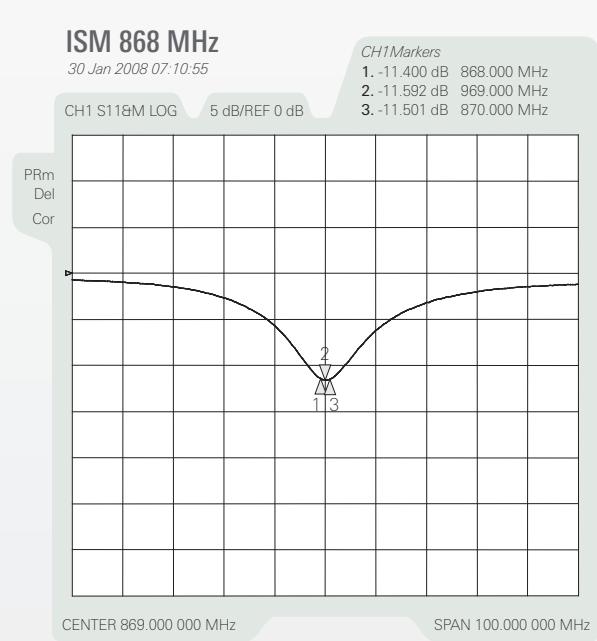

ISM 868 MHz Ceramic Antenna

Ground cleared under antenna, clearance area 10.80 mm x 8.25 mm. Pulse Part Number: W3013

2,4 GHz Typical Free space Radiation Patterns

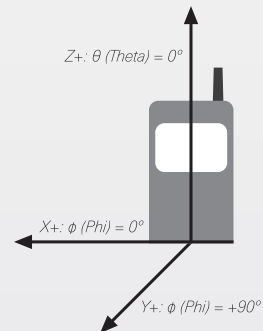
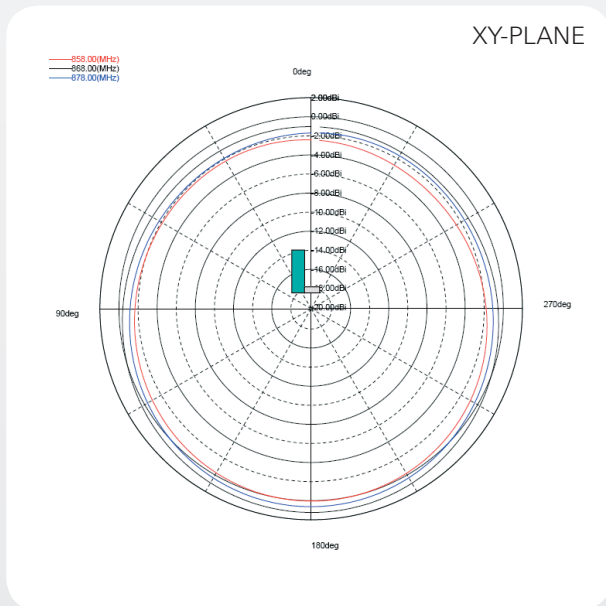
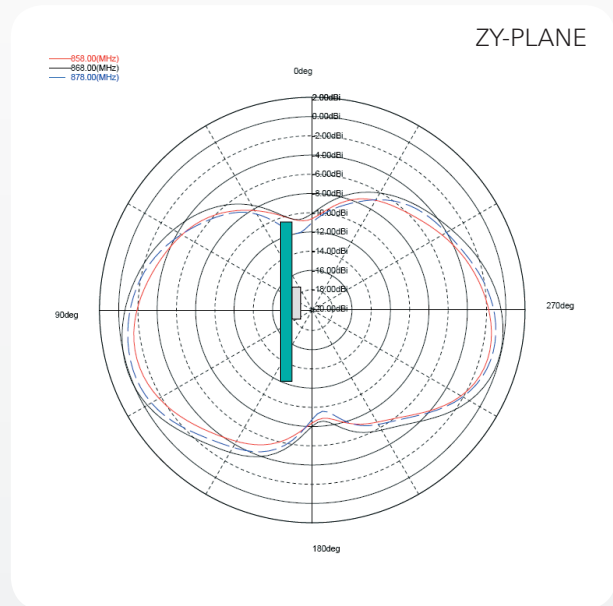
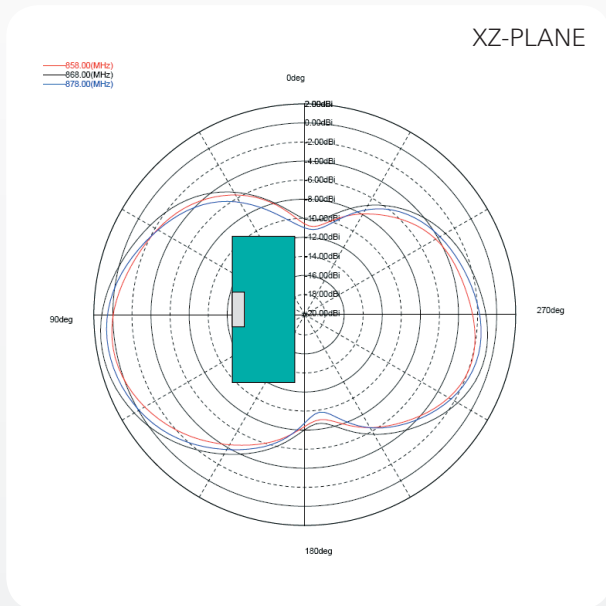

Pulse Finland Oy

Takatie 6
90440 Kempele, Finland
Tel: +358 207 935 500
Fax: +358 207 935 501

www.pulseeng.com/antennas



ISM 868 MHz Ceramic Antenna

Ground cleared under antenna, clearance area 10.80 mm x 8.25 mm. Pulse Part Number: W3013

Packing form

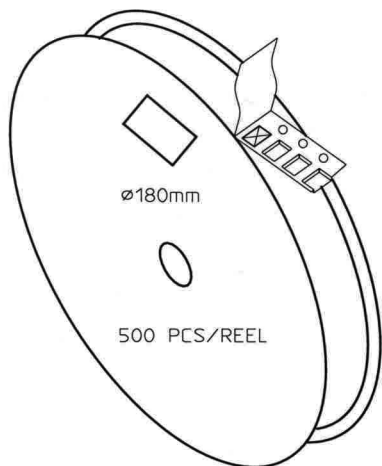

CARRIER TAPE H85-00158
width=24,00 depth=4.15
COVER TAPE H85-00159
width=21.20

LENGTH OF TAPE:

- Leader section: min 350 mm before component section
- Trailer section: min 40 mm after component section.

Empty part cavities at leader and trailer section of the tape must be sealed with top cover tape.

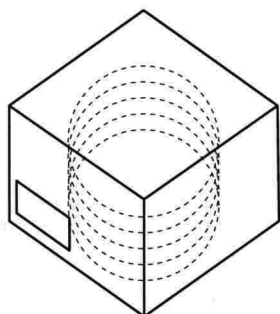

- BOX H85-00128 (182x182x125) 1 pcs
- LABEL 1 pcs/BOX
- REEL H85-00160 (D180, W28) 4 pcs
- REEL LABEL 1 pcs/REEL

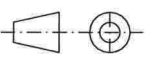
MATERIAL					
HANDLINGS					
		RATIO	DRWN	160107 PeHa	H
			DGNER		G
PRODUCT H90-OY800-F01P01			CHKD		F
			APPRD		E
			APPRD BY		D
					C
					B
DENOMINATION PACKING FORM					A
			VERSION		MOD/DATE/NAME

Pulse Finland Oy

Takatie 6
90440 Kempele, Finland
Tel: +358 207 935 500
Fax: +358 207 935 501
www.pulseeng.com/antennas

