

SCM Series

Series-Connected SuperCapacitor Modules

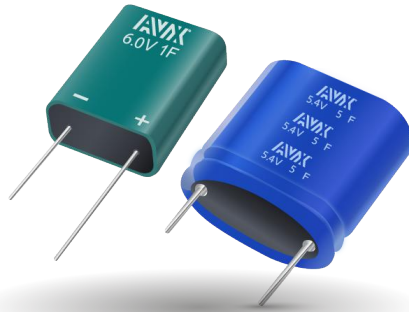

This new series of electrochemical, double-layer, series-connected supercapacitor modules offers excellent pulse power handling characteristics based on the combination of very high capacitance and very low ESR. Used by themselves or in conjunction with primary or secondary batteries, they provide extended back up time, longer battery life, and provide instantaneous power pulses as needed. Offers great solutions to hold up, energy harvesting, pulse power applications, and battery replacement.

FEATURES

- High Pulse Power Capability
- Low ESR
- Low Leakage Current
- Plastic, Moisture Resistant Version

APPLICATIONS

- Camera Flash Systems
- Energy Harvesting
- GSM/GPRS Pulse Applications
- UPS/Industrial
- Wireless Alarms
- Remote Metering
- Scanners
- Toys and Games

HOW TO ORDER

SCM	R	14	C	474	M	R	B	A	0
Series SuperCap Module	Diameter Q = 6.3mm R = 8mm / 9.5mm** S = 10mm T = 12.5mm U = 16mm	Case Length Two digits represent case length in mm	Voltage Code C = 5.0V D = 5.4V F = 5.5V G = 7.5V H = 6.0V J = 8.1V L = 9.0V	Capacitance Code 1st two digits represent significant figures 3rd digit represents multiplier (number of zeros to follow)	Tolerance M = ±20% S = +30% / -10%	Package/Lead Format R = Shrink Wrap/Radial S = Plastic/Radial	Package B = Bulk T = Tray*	Balancing A = Unbalanced B = Passive Balanced	Lead Orientation 0 = Straight Leads 1 = Bent Leads*

*Inquire about availability
**Plastic/Radial version

QUALITY INSPECTION

Parts are tested for life cycle, high temperature load life, temperature characteristics, vibration resistance, and humidity characteristics. See pages 2-5 for more information.

TERMINATION

These supercapacitors are compatible with hand soldering, as well as reflow and wave soldering processes, so long as appropriate precautions are followed. See page 11 for more information.



For RoHS compliant products, please select correct termination style.

5.4V SCM Series



Series-Connected SuperCapacitor Modules

AVX Part Number	Diameter (mm)	Length (mm)	Rated Capacitance (F)	Capacitance Tolerance	Rated Voltage (V)	Rated Temperature (°C)	DCL Max @ 72 Hrs (µA)	ESR Max @ 1000 Hz (mΩ)	ESR Max @ DC (mΩ)	Peak Current (A)	Power Density (W/kg)	Max Energy (Wh)	Energy Density (Wh/kg)
Shrink Wrap / Radial													
SCMQ14C474MRBA0	6.3	14	0.47	±20%	5.0/4.2*	65/85*	2	400	1000	0.80	2143	0.0016	1.17
SCMQ14C474MRTA0	6.3	14	0.47	±20%	5.0/4.2*	65/85*	2	400	1000	0.80	2143	0.0016	1.17
SCMQ14D474MRBB0	6.3	14	0.47	±20%	5.4/4.6*	65/85*	6	400	1000	0.86	2499	0.0019	1.36
SCMQ14D474MRTB0	6.3	14	0.47	±20%	5.4/4.6*	65/85*	6	400	1000	0.86	2499	0.0019	1.36
SCMR14C474MRBA0	8	14	0.47	±20%	5.0/4.2*	65/85*	2	300	1000	0.80	1429	0.0016	0.78
SCMR14D474MRBB0	8	14	0.47	±20%	5.4/4.6*	65/85*	6	300	1000	0.86	1666	0.0019	0.91
SCMR18C105MRBA0	8	18	1	±20%	5.0/4.2*	65/85*	6	200	720	1.45	1667	0.0035	1.39
SCMR18D105MRBB0	8	18	1	±20%	5.4/4.6*	65/85*	10	200	720	1.57	1944	0.0041	1.62
SCMR22C155MRBA0	8	22	1.5	±20%	5.0/4.2*	65/85*	10	190	580	2.01	1669	0.0052	1.68
SCMR22D155MRBB0	8	22	1.5	±20%	5.4/4.6*	65/85*	15	190	580	2.17	1946	0.0061	1.96
SCMS22C255MRBA0	10	22	2.5	±20%	5.0/4.2*	65/85*	20	140	360	3.29	1852	0.0087	1.93
SCMS22D255MRBB0	10	22	2.5	±20%	5.4/4.6*	65/85*	25	140	360	3.55	2113	0.0101	2.20
SCMT22C505MRBA0	12.5	22	5	±20%	5.0/4.2*	65/85*	25	100	150	7.14	2740	0.0174	2.38
SCMT22D505MRBB0	12.5	22	5	±20%	5.4/4.6*	65/85*	30	100	150	7.71	3069	0.0203	2.66
SCMT32C755MRBA0	12.5	32	7.5	±20%	5.0/4.2*	65/85*	65	70	160	8.52	1953	0.0260	2.71
SCMT32D755MRBB0	12.5	32	7.5	±20%	5.4/4.6*	65/85*	70	70	160	9.20	2209	0.0304	3.07

*with appropriate voltage derating operating temperature can be extended to 85°C

OPERATING TEMPERATURE RANGE

-40°C to +65°C @ 5.4V Balanced, 5.0V Unbalanced

-40°C to +85°C @ 4.6V Balanced, 4.2V Unbalanced

QUALIFICATION TEST SUMMARY

Test	Test Method	Parameter	Limits
Life Cycle	Capacitors are cycled between rated voltage and half-rated voltage under constant current at +25°C for 500,000 cycles	Capacitance Change ESR Appearance	≤30% of initial value ≤2 times initial value No remarkable defects
High Temperature Load Life	Temperature: +65°C Voltage: Rated Voltage Test Duration: 2,000 hours	Capacitance Change ESR Appearance	≤30% of initial value ≤2 times initial value No remarkable defects
Storage Temperature Characteristics	Storage Duration: 1 year No Load Temperature: +25°C	Capacitance Change ESR Appearance	≤30% of initial value ≤2 times initial value No remarkable defects
Vibration Resistance	Amplitude: 1.5mm Frequency: 10 ~ 55Hz Direction: X, Y, Z for 2 hours each	Capacitance Change ESR Appearance	≤30% of initial value ≤2 times initial value No remarkable defects
Humidity	Voltage: Rated Voltage RH: 90% Temperature: +60°C Test Duration: 1,500 hours	Capacitance Change ESR Appearance	≤30% of initial value ≤2 times initial value No remarkable defects

6.0V SCM Series

Series-Connected SuperCapacitor Modules



AVX Part Number	Diameter (mm)	Length (mm)	Rated Capacitance (F)	Capacitance Tolerance	Rated Voltage (V)	Rated Temperature (°C)	DCL Max @ 72 Hrs (µA)	ESR Max @ 1000 Hz (mΩ)	ESR Max @ DC (mΩ)	Peak Current (A)	Power Density (W/kg)	Max Energy (Wh)	Energy Density (Wh/kg)
Shrink Wrap / Radial													
SCMQ14F474MRBA0	6.3	14	0.47	±20%	5.5	65	6	500	3000	0.54	864	0.0020	1.41
SCMQ14H474SRBB0	6.3	14	0.47	+30%/-10%	6.0	65	7	500	3000	0.59	1029	0.0024	1.68
SCMR14F474MRBA0	8	14	0.47	±20%	5.5	65	6	380	1720	0.71	1005	0.0020	0.94
SCMR14H474MRBB0	8	14	0.47	±20%	6.0	65	7	380	1720	0.78	1196	0.0024	1.12
SCMR18F105MRBA0	8	18	1	±20%	5.5	65	6	250	720	1.60	2017	0.0042	1.68
SCMR18H105MRBB0	8	18	1	±20%	6.0	65	12	250	720	1.74	2400	0.0050	2.00
SCMR22F155MRBA0	8	22	1.5	±20%	5.5	65	12	200	560	2.24	2091	0.0063	2.03
SCMR22H155MRBB0	8	22	1.5	±20%	6.0	65	18	200	560	2.45	2488	0.0075	2.42
SCMS22F255MRBA0	10	22	2.5	±20%	5.5	65	24	180	340	3.72	2373	0.0105	2.33
SCMS22H255MRBB0	10	22	2.5	±20%	6.0	65	30	180	340	4.05	2762	0.0125	2.72
SCMS32F505MRBA0	10	32	5	±20%	5.5	65	30	120	150	7.86	3580	0.0210	3.11
SCMS32H505MRBB0	10	32	5	±20%	6.0	65	36	120	150	8.57	4235	0.0250	3.68
SCMT22F505MRBA0	12.5	22	5	±20%	5.5	65	30	120	150	7.86	3176	0.0210	2.76
SCMT32F755MRBA0	12.5	32	7.5	±20%	5.5	65	78	90	120	10.86	3151	0.0315	3.28
SCMT32H755MRBB0	12.5	32	7.5	±20%	6.0	65	85	90	120	11.84	3600	0.0375	3.75
SCMU33F156MRBB0	16	33	15	±20%	5.5	65	70	35	50	23.57	3946	0.0630	3.43
Plastic / Radial													
SCMR14F474MSBA0	9.5	16	0.47	±20%	5.5	65	3	380	1720	0.71	541	0.0020	0.51
SCMR14H474MSBB0	9.5	16	0.47	±20%	6.0	65	7	380	1720	0.78	644	0.0024	0.60
SCMR18F105MSBA0	9.5	20	1	±20%	5.5	65	7	250	720	1.60	1096	0.0042	0.91
SCMR18H105MSBB0	9.5	20	1	±20%	6.0	65	12	250	720	1.74	1304	0.0050	1.09
SCMR22F155MSBA0	9.5	24	1.5	±20%	5.5	65	12	200	560	2.24	1179	0.0063	1.15
SCMR22H155MSBB0	9.5	24	1.5	±20%	6.0	65	18	200	560	2.45	1403	0.0075	1.36

OPERATING TEMPERATURE RANGE

-40°C to +65°C

QUALIFICATION TEST SUMMARY

Test	Test Method	Parameter	Limits
Life Cycle	Capacitors are cycled between rated voltage and half-rated voltage under constant current at +25°C for 500,000 cycles	Capacitance Change ESR Appearance	≤30% of initial value ≤2 times initial value No remarkable defects
High Temperature Load Life	Temperature: +65°C Voltage: Rated Voltage Test Duration: 2,000 hours	Capacitance Change ESR Appearance	≤30% of initial value ≤2 times initial value No remarkable defects
Storage Temperature Characteristics	Storage Duration: 1 year No Load Temperature: +25°C	Capacitance Change ESR Appearance	≤30% of initial value ≤2 times initial value No remarkable defects
Vibration Resistance	Amplitude: 1.5mm Frequency: 10 ~ 55Hz Direction: X, Y, Z for 2 hours each	Capacitance Change ESR Appearance	≤30% of initial value ≤2 times initial value No remarkable defects
Humidity	Voltage: Rated Voltage RH: 90% Temperature: +60°C Test Duration: 1,500 hours	Capacitance Change ESR Appearance	≤30% of initial value ≤2 times initial value No remarkable defects

7.5V SCM Series



Series-Connected SuperCapacitor Modules

AVX Part Number	Diameter (mm)	Length (mm)	Rated Capacitance (F)	Capacitance Tolerance	Rated Voltage (V)	Rated Temperature (°C)	DCL Max @ 72 Hrs (µA)	ESR Max @ 1000 Hz (mΩ)	ESR Max @ DC (mΩ)	Peak Current (A)	Power Density (W/kg)	Max Energy (Wh)	Energy Density (Wh/kg)
Shrink Wrap / Radial													
SCMR14G334MRBA0	8	14	0.33	±20%	7.5/6.4*	65/85*	2	450	900	0.95	2419	0.0026	0.83
SCMR14G334MRBB0	8	14	0.33	±20%	7.5/6.4*	65/85*	6	450	900	0.95	2419	0.0026	0.83
SCMR18G604MRBA0	8	18	0.6	±20%	7.5/6.4*	65/85*	6	225	450	1.77	3947	0.0047	1.23
SCMR18G604MRBB0	8	18	0.6	±20%	7.5/6.4*	65/85*	10	225	450	1.77	3846	0.0047	1.20
SCMR22G105MRBA0	8	22	1	±20%	7.5/6.4*	65/85*	10	180	360	2.76	4076	0.0078	1.70
SCMR22G105MRBB0	8	22	1	±20%	7.5/6.4*	65/85*	15	180	360	2.76	3989	0.0078	1.66

*with appropriate voltage derating operating temperature can be extended to 85°C

OPERATING TEMPERATURE RANGE

-40°C to +65°C @ 7.5V
 -40°C to +85°C @ 6.4V

QUALIFICATION TEST SUMMARY

Test	Test Method	Parameter	Limits
Life Cycle	Capacitors are cycled between rated voltage and half-rated voltage under constant current at +25°C for 500,000 cycles	Capacitance Change ESR Appearance	≤30% of initial value ≤2 times initial value No remarkable defects
High Temperature Load Life	Temperature: +65°C Voltage: Rated Voltage Test Duration: 2,000 hours	Capacitance Change ESR Appearance	≤30% of initial value ≤2 times initial value No remarkable defects
Storage Temperature Characteristics	Storage Duration: 1 year No Load Temperature: +25°C	Capacitance Change ESR Appearance	≤30% of initial value ≤2 times initial value No remarkable defects
Vibration Resistance	Amplitude: 1.5mm Frequency: 10 ~ 55Hz Direction: X, Y, Z for 2 hours each	Capacitance Change ESR Appearance	≤30% of initial value ≤2 times initial value No remarkable defects
Humidity	Voltage: Rated Voltage RH: 90% Temperature: +60°C Test Duration: 1,500 hours	Capacitance Change ESR Appearance	≤30% of initial value ≤2 times initial value No remarkable defects

9.0V SCM Series



Series-Connected SuperCapacitor Modules

AVX Part Number	Diameter (mm)	Length (mm)	Rated Capacitance (F)	Capacitance Tolerance	Rated Voltage (V)	Rated Temperature (°C)	DCL Max @ 72 Hrs (µA)	ESR Max @ 1000 Hz (mΩ)	ESR Max @ DC (mΩ)	Peak Current (A)	Power Density (W/kg)	Max Energy (Wh)	Energy Density (Wh/kg)
Shrink Wrap / Radial													
SCMR14J334MRBA0	8	14	0.33	±20%	8.1	65	3	500	2850	0.69	897	0.0030	0.98
SCMR14J334MRBB0	8	14	0.33	±20%	8.1	65	6	500	2850	0.69	869	0.0030	0.95
SCMR14L334MRBB0	8	14	0.33	±20%	9.0	65	7	500	2850	0.77	1072	0.0037	1.17
SCMR18J604MRBA0	8	18	0.6	±20%	8.1	65	7	400	1080	1.47	1934	0.0055	1.45
SCMR18J604MRBB0	8	18	0.6	±20%	8.1	65	15	400	1080	1.47	1869	0.0055	1.40
SCMR18L604MRBB0	8	18	0.6	±20%	9.0	65	12	400	1080	1.64	2308	0.0068	1.73
SCMR22J105MRBA0	8	22	1	±20%	8.1	65	12	350	840	2.20	1986	0.0091	1.93
SCMR22J105MRBB0	8	22	1	±20%	8.1	65	15	350	840	2.20	1894	0.0091	1.84
SCMR22L105MRBB0	8	22	1	±20%	9.0	65	18	350	840	2.45	2338	0.0113	2.27
Plastic / Radial													
SCMR14J334MSBA0	9.5	16	0.33	±20%	8.1	65	3	500	2850	0.69	498	0.0030	0.54
SCMR14L334MSBB0	9.5	16	0.33	±20%	9.0	65	7	500	2850	0.77	598	0.0037	0.65
SCMR18J604MSBA0	9.5	20	0.6	±20%	8.1	65	7	400	1080	1.47	1063	0.0055	0.80
SCMR18L604MSBB0	9.5	20	0.6	±20%	9.0	65	12	400	1080	1.64	1286	0.0068	0.96
SCMR22J105MSBA0	9.5	24	1	±20%	8.1	65	12	350	840	2.20	1129	0.0091	1.10
SCMR22L105MSBB0	9.5	24	1	±20%	9.0	65	18	350	840	2.45	1361	0.0113	1.32

OPERATING TEMPERATURE RANGE

-40°C to +65°C

QUALIFICATION TEST SUMMARY

Test	Test Method	Parameter	Limits
Life Cycle	Capacitors are cycled between rated voltage and half-rated voltage under constant current at +25°C for 500,000 cycles	Capacitance Change ESR Appearance	≤30% of initial value ≤2 times initial value No remarkable defects
High Temperature Load Life	Temperature: +65°C Voltage: Rated Voltage Test Duration: 2,000 hours	Capacitance Change ESR Appearance	≤30% of initial value ≤2 times initial value No remarkable defects
Storage Temperature Characteristics	Storage Duration: 1 year No Load Temperature: +25°C	Capacitance Change ESR Appearance	≤30% of initial value ≤2 times initial value No remarkable defects
Vibration Resistance	Amplitude: 1.5mm Frequency: 10 ~ 55Hz Direction: X, Y, Z for 2 hours each	Capacitance Change ESR Appearance	≤30% of initial value ≤2 times initial value No remarkable defects
Humidity	Voltage: Rated Voltage RH: 90% Temperature: +60°C Test Duration: 1,500 hours	Capacitance Change ESR Appearance	≤30% of initial value ≤2 times initial value No remarkable defects

QUALITY AND RELIABILITY

Capacitance vs. Temperature

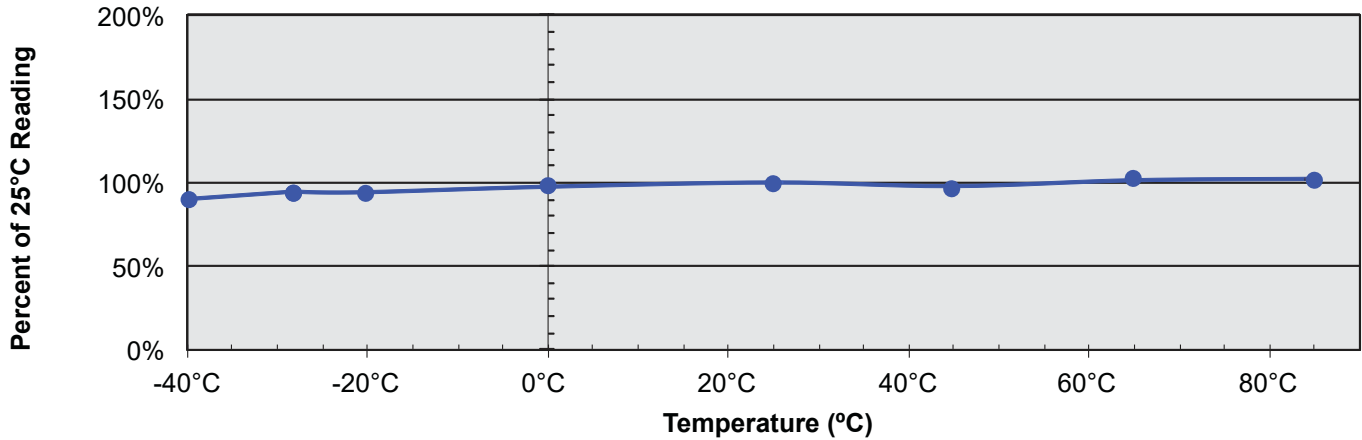

Leakage Current vs. Temperature

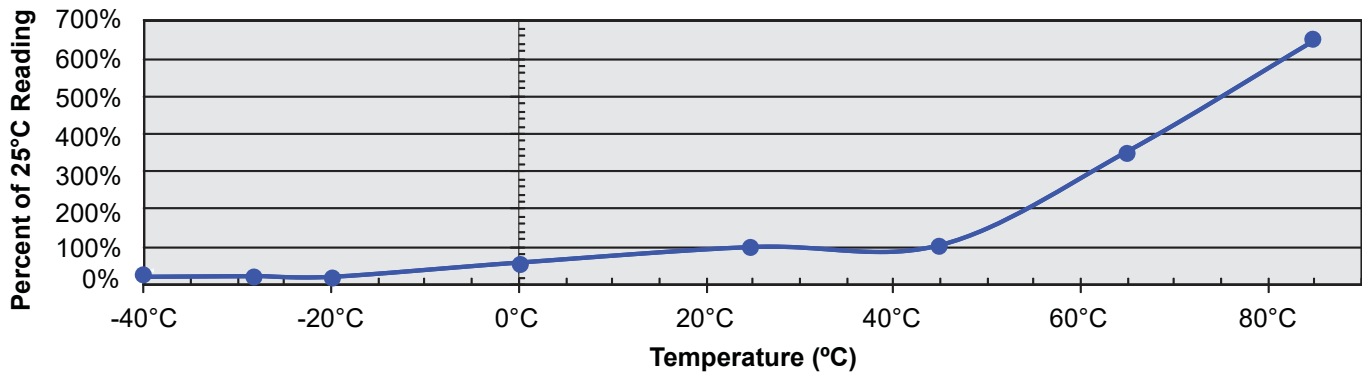

Equivalent Series Resistance vs. Temperature

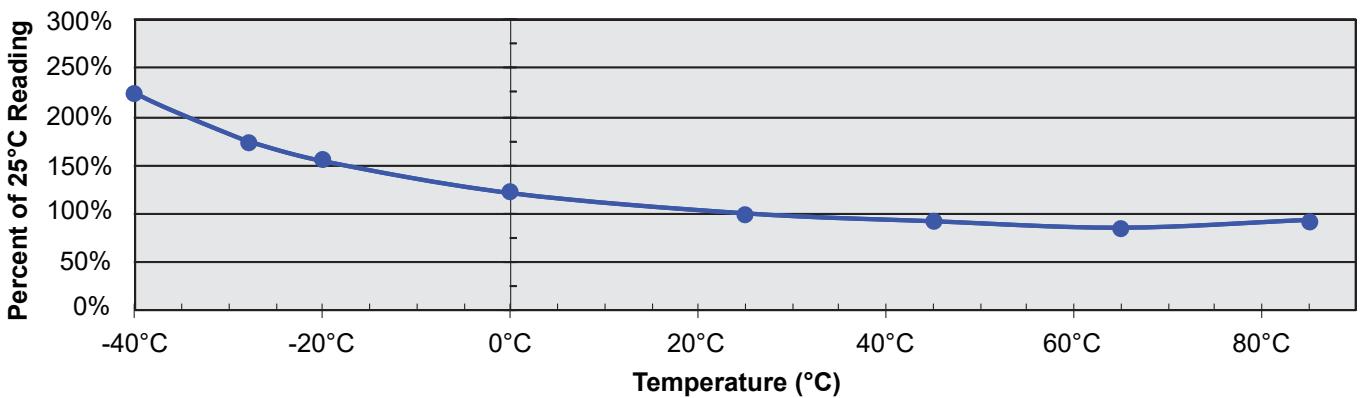

MECHANICAL SPECIFICATIONS

5.4V, 6.0V Shrink Wrap Type - Straight Leads

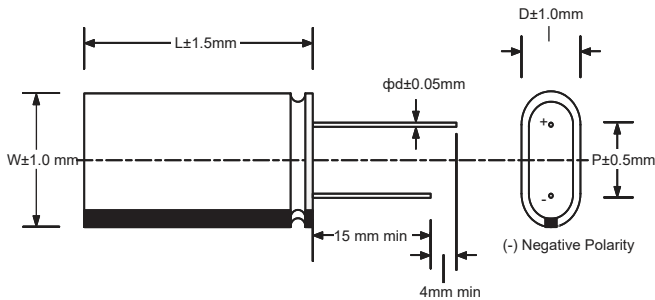

5.4V, 6.0V Shrink Wrap Type - Bent Leads

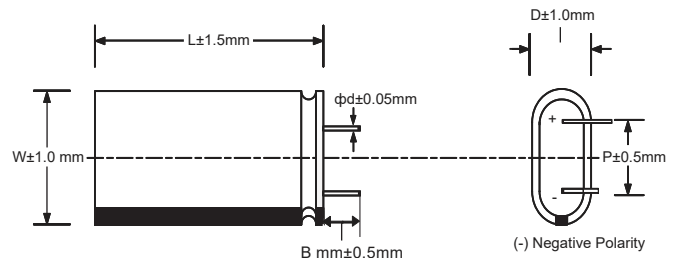

Cap (F)	D (mm)	W (mm)	L (mm)	P (mm)	d (mm)	B (mm)*
0.47	6.3	13.6	14.0	9.0	0.6	2.0
0.47	8.0	16.0	14.0	11.5	0.6	2.0
1	8.0	16.0	18.0	11.5	0.6	2.0
1.5	8.0	16.0	22.0	11.5	0.6	2.0
2.5	10.0	20.0	22.0	15.5	0.6	2.0
5	10.0	20.0	32.0	15.5	0.6	2.0
5	12.5	25.0	22.0	18.0	0.6	2.0
7.5	12.5	25.0	32.0	18.0	0.6	2.0
15	16.0	32.0	33.0	23.7	0.6	2.0

*for version with bent leads

7.5V, 9.0V Shrink Wrap Type - Straight Leads

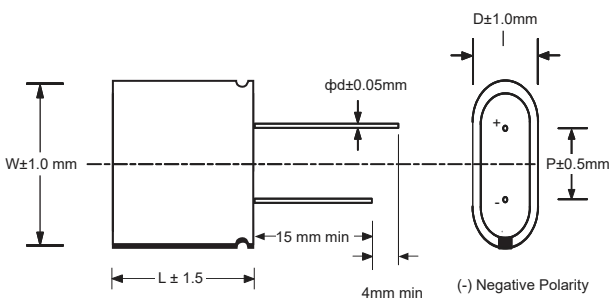

7.5V, 9.0V Shrink Wrap Type - Bent Leads

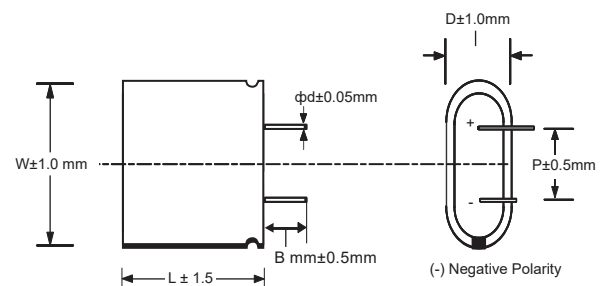

Cap (F)	D (mm)	W (mm)	L (mm)	P (mm)	d (mm)	B (mm)*
0.33	8.0	24.0	14.0	13.5	0.6	2.0
0.6	8.0	24.0	18.0	13.5	0.6	2.0
1	8.0	24.0	22.0	13.5	0.6	2.0

*for version with bent leads

MECHANICAL SPECIFICATIONS

6.0V Plastic Type - Straight Leads

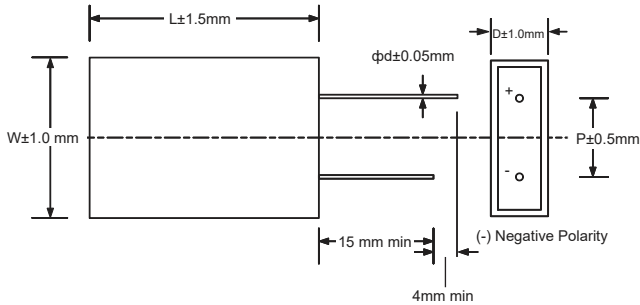

6.0V Plastic Type - Bent Leads

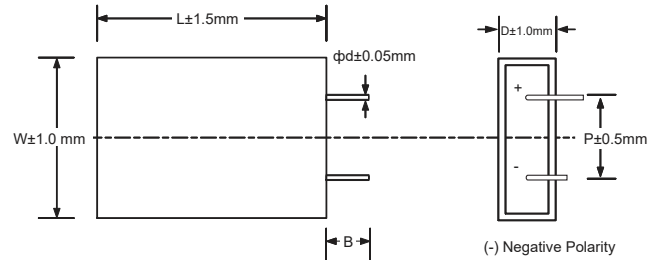

Cap (F)	D (mm)	W (mm)	L (mm)	P (mm)	d (mm)	B (mm)*
0.47	9.5	18.5	16.0	11.5	0.6	2.0
1	9.5	18.5	20.0	11.5	0.6	2.0
1.5	9.5	18.5	24.0	11.5	0.6	2.0

*for version with bent leads

9.0V Plastic Type - Straight Leads

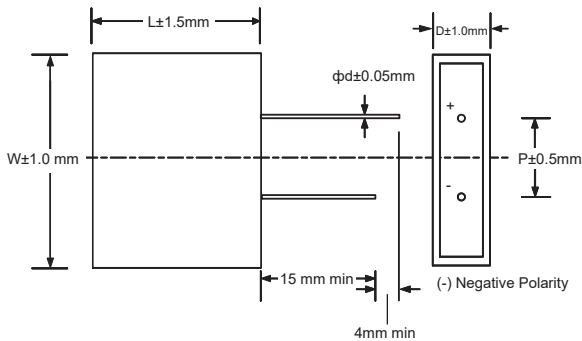

9.0V Plastic Type - Bent Leads

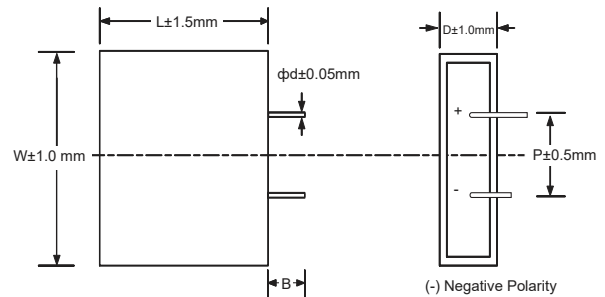

Cap (F)	D (mm)	W (mm)	L (mm)	P (mm)	d (mm)	B (mm)*
0.33	9.5	26.6	16.0	11.5	0.6	2.0
0.6	9.5	26.6	20.0	11.5	0.6	2.0
1	9.5	26.6	24.0	11.5	0.6	2.0

*for version with bent leads

TEST METHODS

IEC Capacitance Test Method

- Capacitance is measured using a Keithley 2400 or 2602 Meter
- Procedure
 - Charge Capacitor to Rated Voltage at room temperature
 - Disconnect parts from voltage to remove charging effects
 - Discharge cells with a constant current I determined by $4 * C * V_R$
 - Noting V_1 , t_1 , V_2 , t_2 and performing the calculation for C

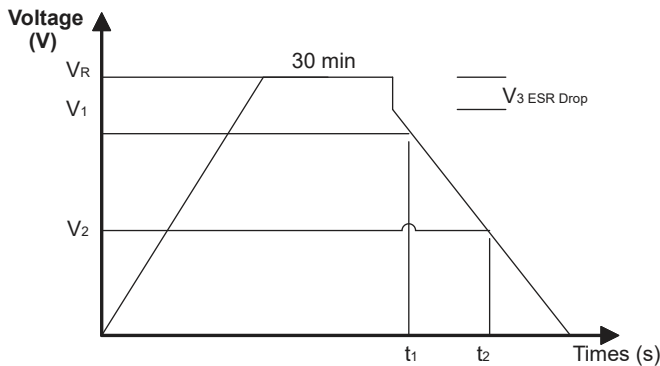

I – Discharge Current [mA], $4 * C * V_R$ V_R – Rated Voltage
 V_1 – Initial Test Voltage, 80% of V_R
 V_2 – Final Test Voltage, 40% of V_R
 t_1 – Initial Test time
 t_2 – Final Test time
 $C = I * (t_2 - t_1) / (V_1 - V_2)$

DCL Measurement @ 25°C

- DCL is measured using a Multimeter with high internal impedance across a resistor
 - Charge Capacitor to Rated Voltage at room temperature for 72 Hours
 - Disconnect parts from Voltage by opening switch 1 (Stabilize for 10 Min)
 - Measure Voltage across a known Valued Resistor (1K Ohm)
 - Calculate $DCL = V/R$

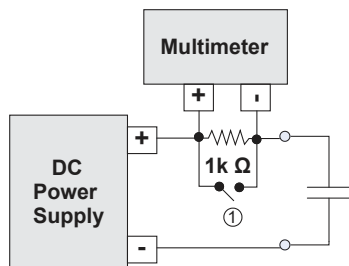

Initial ESR Measurement @ 25°C

- Using an Agilent 4263B LCR Meter and a Kelvin connection
 - Measure at frequency of 1000 Hz
 - Measurement Voltage of 10mV

DC ESR Measurement

- Six steps capacity and ESRDC Test Method is used as illustrated in the figure right.
- Tests are carried out by charging and discharging the capacitor for two cycles at rated voltage and half rated voltage
 - $C = (C_{DC1} + C_{DC2}) / 2$
 - $ESR_{DC} = (ESR_{DC1} + ESR_{DC2}) / 2$ Where: $C_{DC1} = I_2 * (t_5 - t_4) / (V_3 - V_4)$ $C_{DC2} = I_2 * (t_{11} - t_{10}) / (V_9 - V_{10})$
 - $ESR_{DC1} = (V_5 - V_4) / I_2$
 - $ESR_{DC2} = (V_{11} - V_{10}) / I_2$ $I_1 = I_2 = 75mA/F$

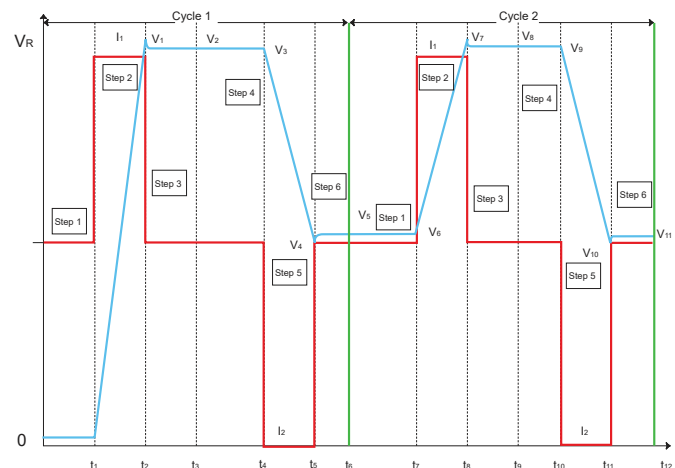

Maximum Operating Current

- This is the maximum current when capacitor temperature rise of the capacitor during its operation is less than 15°C

Maximum Peak Current

- This is the maximum current in less than 1 sec

Watt Density

- Watt Density = $(0.12 * V^2 / R_{DC}) / \text{mass}$

Energy Density

- Energy density = $(\frac{1}{2} CV^2) / (3600 * \text{mass})$

POLARITY / REVERSE VOLTAGE

In principal the positive and negative electrodes of the supercapacitors are symmetrical and in theory they should not have a polarity but for product consistency and for optimum performance the negative polarity is marked because the capacitors do not discharge completely when in use. It is recommended that

the polarity should be used as marked. If the polarity is reversed the circuit will not have a catastrophic failure but the circuit will see a much higher leakage current for a short duration of time and the life time of the supercapacitors will be reduced.

LIFE TIME AND TEMPERATURE PERFORMANCE

The life of a supercapacitor is impacted by a combination of operating voltage and the operating temperature according to the following equation:

time to failure, $t \propto V^n \cdot \exp(-Q / k \cdot T)$
(1) where V is the voltage of operation, Q is the activation energy in electron volts (eV), k is the Boltzmann's constant in eV and T is the operating temperature in °K (where K is in degrees Kelvin). Typical values for the voltage exponent, n, is between 2.5 - 3.5, and Q is between 1.0 - 1.2 eV in the normal

operating temperature range of 40° to 65°C. The industry standard for supercapacitor end of life is when the equivalent series resistance, ESR, increases to 200% of the original value and the capacitance drops by 30%. Typically a supercapacitor shows an initial change in the ESR value and then levels off. If the capacitors are exposed to excessive temperatures the ESR will show a continuous degradation. In the extreme case, if the temperatures or voltages are substantially higher, than the rated voltage, this will lead to cell leakage or gas leakage and the product will show a faster change in the ESR which may increase to many times the original value.

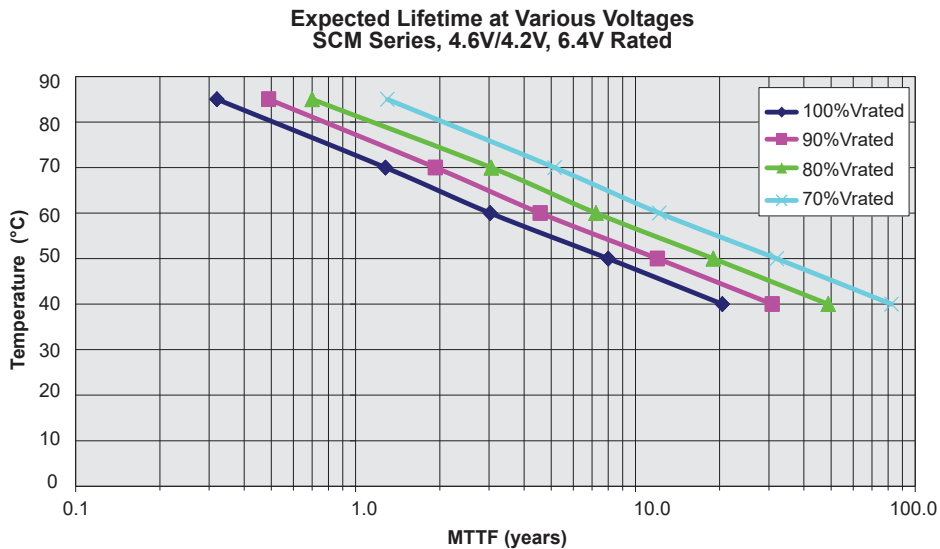
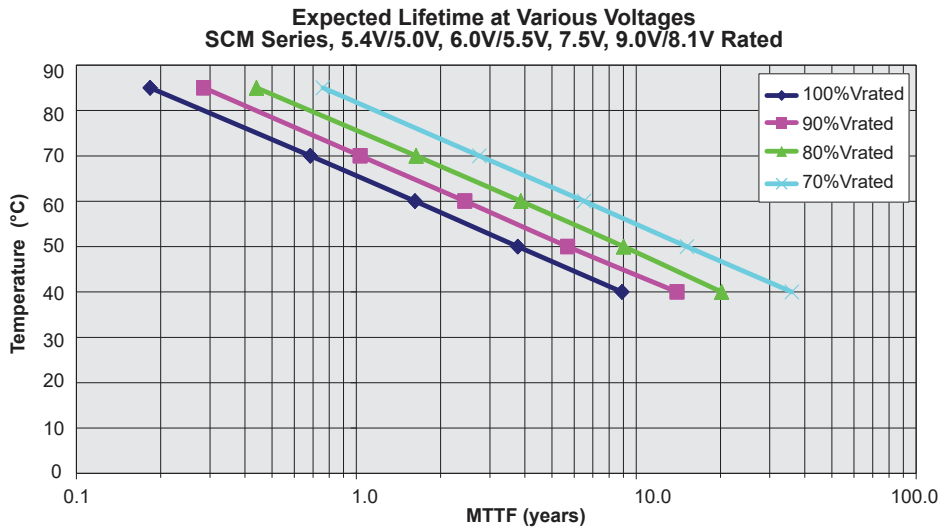

SOLDERING RECOMMENDATIONS

When soldering supercapacitors to a PCB, the temperature & time that the body of the supercapacitor sees during soldering can have a negative effect on performance. We advise following these guidelines:

- Do not immerse the supercapacitors in solder. Only the leads should come in contact with the solder.
- Ensure that the body of the supercapacitor is not in contact with the PCB or other components during soldering. Temperature cycling during soldering may cause the case to shrink or crack, potentially damaging the PCB or other components.

HAND SOLDERING

Keep some distance between the supercapacitor body and the tip of the soldering iron; contact between supercapacitor body and soldering iron will cause extensive damage to the supercapacitor. It is recommended that the soldering iron temperature should be less than 350°C, and contact time should be limited to no more than 4 seconds. Too much exposure to terminal heat during soldering can cause heat to transfer to the body of the supercapacitor, potentially damaging the supercapacitor.

WAVE SOLDERING

Only use wave soldering on Radial type supercapacitors. The PCB should be preheated for no longer than 60 seconds, with temperature at, or below, 100°C. Soldering tin should be 0.8mm or thicker.

Solder Temperature (°C)	Suggested Solder Time (s)	Maximum Solder Time (s)
220	7	9
240	7	9
250	5	7
260	3	5

REFLOW SOLDERING

Infrared or conveyor over reflow techniques can be used on these supercapacitors. Do not use a traditional reflow oven without clear rated reflow temperature for supercapacitors.

SAFETY RECOMMENDATIONS

Warnings

- To avoid short circuit, after usage or test, supercapacitor voltage needs to discharge to $\leq 0.1V$
- Do not apply over-voltage, reverse charge, burn or heat higher than 150°C, explosion-proof valve may break open
- Do not press, damage or disassemble the supercapacitor, housing could heat to high temperature causing burns
- If you observe overheating or burning smell from the capacitor disconnect power immediately, and do not touch

Emergency Applications

- If housing is leaking:
 - Skin contact: use soap and water thoroughly to wash the area of the skin
 - Eye contact: flush with flowing water or saline, and immediately seek medical treatment
 - Ingestion: immediately wash with water and seek medical treatment

Transportation

Not subjected to US DOT or IATA regulations
 UN3499, <10Wh, Non-Hazardous Goods
 International shipping description –
 “Electronic Products – Capacitor”

Regulatory

- UL 810A
- RoHS Compliant
- Reach Compliant / Halogen Free

Storage

- Capacitors may be stored within the operating temperature range of the capacitor
- Lower storage temperature is preferred as it extends the shelf life of the capacitor
- Do not store the supercapacitors in the following environments
 - High temperature / high humidity environments >70°C / 40% RH
 - Direct sunlight
 - In direct contact with water, salt oil or other chemicals
 - In direct contact with corrosive materials, acids, alkalis, or toxic gases
 - Dusty environment
 - In environment with shock and vibration conditions

Licensed by CAP-XX



NORTH AMERICA

Tel: 864-967-2150

SOUTH AMERICA

Tel: +55 11-46881960



EUROPE

Tel: +44 1276-697000



ASIA

Tel: +65 6286-7555

JAPAN

Tel: +81 740-321250

Contact:

<http://www.avx.com>

AVX[®]