

flexible couplings

The Company & Its Products

Huco products are manufactured in Hertford, England, in a modern plant equipped with all necessary design, development, toolroom and production facilities. The plant operates a total quality assurance system assessed to ISO 9001-2000.

Huco products are available through distribution or Huco warehouses in most of the industrialised nations of the world. Recognised as one of the leading manufacturers of small flexible couplings, Huco has been responsible for several 'firsts' since its inception in 1965

Huco was first to use thermoplastics as active transmission elements and was demonstrating plastic universal joints as far back as 1962. Other 'moving parts' couplings followed, notably the Uni-Lat and Oldham concepts. In the early 1990's Huco launched the Flex-M high integrity membrane coupling and this was followed by the Flex-B series of bellows couplings, another new and innovative design.

With the recent addition of the Multi-Beam and Single-Beam range of helical beam couplings, Huco can offer solutions that address specific issues in most coupling applications.

Whether the accent is on high torsional stiffness, generous misalignment capability, high speed operation recyclable hubs, or a capacity for operating in push/pull mode, Huco can help. If your needs should fall outside our standard range, we offer a customised service to meet your low-cost, high volume requirements.

Contents













PRODUCT OVERVIEW	4 - 5
SELECTING FLEXIBLE COUPLINGS	6
HOW TO ORDER	7
INSTALLING COUPLINGS	8 - 10
HIGH PERFORMANCE COUPLINGS <i>Huco-Flex B, Huco-Flex Ni & Huco-Flex M</i>	11 - 20
GENERAL PURPOSE MOTION CONTROL COUPLINGS <i>Huco-Oldham & Uni-Lat</i>	21 - 26
BEAM COUPLINGS <i>Single Beam, Multi-Beam, Step Beam</i>	27 - 36
LIGHT POWER DRIVE COUPLINGS <i>Jaw (Spider), Double Loop & Magnetic Couplings</i>	37 - 42
PLASTIC UNIVERSAL JOINTS & TELESHAFTS <i>Huco-Pol & Huco Teleshaf</i>	43 - 48
ADJUSTABLE FRICTION CLUTCHES <i>Huco Vari-Tork</i>	49 - 52
BEVEL GEARBOXES <i>Huco L-Box & Huco T-Box</i>	53 - 54
BORE ADAPTORS <i>Huco-Lok</i>	55 - 56
FORMULAE & CONVERSION FACTORS <i>For Motion Transfer</i>	57 - 59













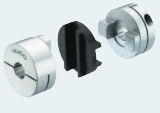

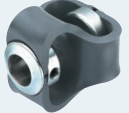

Certificate No. GB00304

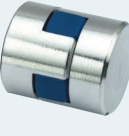
Product Overview

Product Overview

Stainless Steel Bellows type	Nickel Bellows type	Membrane type	Multi-Beam type	Single-Beam type	Step-Beam type
<p>Flex B Short 3-convolution</p>  <p>Stretched 2-convolution</p>  <p>Long 9-convolution</p> 	<p>Flex Ni</p>  	<p>Flex M Single-stage</p>  <p>Short two-stage</p>  <p>Long two-stage</p> 	<p>Multi-Beam 6-Beam</p>   <p>Material Options: Aluminium Stainless Steel Acetal</p>	<p>Single-Beam</p>  <p>Material Options: Aluminium Stainless Steel</p>	<p>Step-Beam</p>  <p>Material Options: Nylon</p>
General description					
Precision couplings with excellent kinematic properties. The 3 types offer differing combinations of stiffness, radial compensation and axial motion.	Precision couplings with excellent kinematic properties. The 3 types offer differing combinations of stiffness, radial compensation and axial motion.	Precision couplings with excellent kinematic properties. Dynamically balanced construction. Single-stage versions make up into 'whirl' free Cardans. The 2-stage versions offer short envelopes and low bearing loads respectively.	General purpose single piece couplings Single stage (3-beam) Two stage (6-beam) Material options for moisture and corrosion resistance.	More flexible than Multi-Beam but less torsional rigidity.	Unique coupling design gives excellent combination of radial flexibility with torsional stiffness.
Where to use					
High-end servo drives, pulse generators, scanners, positioning slides, metering valves, etc.	High-end servo drives, pulse generators, scanners, positioning slides, metering valves, etc.	High-end servo drives, pulse generators, scanners, positioning slides, high speed dynamometers, unsupported drive shafts, etc.	Stepper and servo drives, encoders, general purpose light duty power transmission applications.	Stepper drives, encoders, general purpose light duty power transmission applications.	Encoders, tachogenerators, small pumps, motors and drives
Speeds					
Up to 5000 rpm in standard form.	Up to 5000 rpm in standard form.	Up to 5000 rpm in standard form. Up to 30000 rpm in balanced form.	Up to 5000 rpm in standard form. Up to 30000 rpm in balanced form.	Up to 5000 rpm in standard form. Up to 30000 rpm in balanced form.	Up to 10000 rpm
Peak torque largest size					
12.5 Nm	12.5 Nm	60 Nm	140 Nm	30 Nm	25 Nm
Standard bores					
3 to 20	3 to 20	3 to 28	1 to 38	3 to 26	3 to 12.7
Temperature range					
-40° to +120°C	-40° to +120°C	-40° to +120°C	-40° to +140°C	-40° to +140°C	-20 to +150°C
Electrically isolating					
No, unless used with insulating bore adaptors	No, unless used with insulating bore adaptors	No, unless used with insulating bore adaptors	Aluminium } No Stainless Steel } Acetal } Yes	Aluminium } No Stainless Steel }	Yes
Connection					
Clamp or Set Screw	Clamp or Set Screw	Clamp or Set Screw	Clamp or set screw	Clamp or Set Screw	Clamp or Set Screw
Page 12 - 13	Page 14 - 15	Page 16 - 19	Page 28 - 33	Page 34 - 35	Page 36

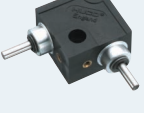
Product Overview

Sliding Disc type	Universal / Lateral type	Double Loop type	Jaw Coupling	Universal Joints & Teleshfts	Friction Clutches	Bevel Gearboxes
<p>Oldham Blind bored</p>  <p>Thru' bored</p>  <p>Thru' bored</p>  <p>Material Options: Aluminium Stainless Steel</p>	<p>Uni-Lat</p>  	<p>Flex-P</p>   	<p>Jaw coupling</p> 	<p>Huco-Pol Single joints</p>  <p>Double joints</p>  <p>Teleshfts</p> 	<p>Vari-Tork Basic clutch</p>  <p>Basic clutch + sleeve adaptor</p>  <p>Basic clutch + Oldham coupling</p> 	<p>L-Box</p>  <p>T-Box</p> 
General description						
<p>General purpose, robust, easy to use 3-part couplings with replaceable wear elements. Generous radial compensation and pull-apart / re-engage facility for blind assemblies.</p>	<p>Unique, general purpose light duty couplings with generous angular and radial misalignment compensation. Resist axial motion, can anchor unrestricted shafts and perform light push/pull duties.</p>	<p>Exceptional flexibility in all three directions, radial, angular and axial</p>	<p>High torque capacity and high speed are available from this naturally balanced coupling</p>	<p>Light duty plastic universal joints and extensible drive shafts (teleshfts). Low mass, corrosion resistant, ideal where conventional steel joints would be under-utilised.</p>	<p>Small, user-adjustable torque limiters for concentric or in-line mounting. Operate by friction using interleaved clutch plates.</p>	<p>Small 90° drives encased in molded housings providing electrical isolation between shafts and mounting surface. The L-Box is rated for intermittent use, the T box for continuous. 1:1 & 2:1 ratios are available with the T-Box.</p>
Where to use						
<p>Stepper drives for most applications including positioning slides, pumps, actuators, etc.</p>	<p>Encoder, resolver, tacho, potentiometer drives. Small positioning slides, dosing pumps, & light drives generally.</p>	<p>Light power drives, pumps and small generators</p>	<p>Light power drives where misalignment is small</p>	<p>Intermittent applications in business machines, instrumentation, lab equipment, analytical apparatus, etc., where steel joints would be under-utilised.</p>	<p>Friction clutches interrupt rotation when the load being transmitted reaches a pre-determined threshold. Used in all kinds of small drives to help protect personnel and equipment.</p>	<p>L-box offers a compact means to route drives thru' 90°. T-box offers 2 & 3 shaft configurations for multiple power offtake.</p>
Speeds						
Up to 3000 rpm.	Up to 3000 rpm.	Up to 3000 rpm.	Up to 40,000 rpm.	Up to 1000 rpm	Up to 1000 rpm slipping speed	Up to 1500 rpm for T-box
Peak torque largest size						
44 Nm	12 Nm	18 Nm	133 Nm	10.7 Nm	3 Nm	0.68 Nm
Standard bores						
2 to 30	3 to 22	3 to 16	3 to 16	3 to 20	6 to 20	4 & 5 (shafts)
Temperature range						
-20 to +60°C	-20 to +60°C	-40 to +100°C	-40 to +80°C	-20 to +60°C	-10 to +80°C (when operating)	-20 to +60°C
Electrically isolating						
Yes	Yes	Yes	Yes	Yes	No	See General Description above
Connection						
Clamp or Set Screw	Clamp or Set Screw	Set Screw	Clamp or Set Screw	Set Screw, Bonding, or Cross-Pinning	Clamp or Set Screw	N/A
Page 24 - 26	Page 22 - 23	Page 40	Page 38 - 39	Page 44 - 48	Page 50 - 52	Page 54

Selecting Flexible Couplings

Introduction to couplings

In the simplest of terms a coupling's purpose is to transfer rotational movement from one shaft to another. Reality is somewhat more complicated, though, as flexible shaft couplings have also to compensate for misalignment between two shafts. This ability must be balanced with the need to be pliable in the planes of misalignment while still having the torsional strength to carry out the coupling's main function. This is known as the Compliance mechanism where compliance is the capacity for allowing relative displacement.

Several factors should always be taken into consideration when looking to specify flexible shaft couplings. These are torsional stiffness, backlash, torque, life and attachment system. All of these have bearing on coupling selection.

Selecting the ideal coupling

The choice of couplings available to today's engineers can be daunting, but follow our guide;lines and you will arrive at the optimum coupling for your particular application.

- Does the coupling provide adequate misalignment protection?
- Can it transmit the required torque?
- Do I need axial motion or axial stiffness?
- Can it sustain the required speed of rotation?
- Will it fit within the available space envelope?
- Can it operate at the designated ambient temperature?
- Does it provide torsional stiffness required for positional accuracy?
- Does it provide electrical isolation between the shafts?
- Will it have the required life expectancy?



6 Service Factors

- Peak torque values quoted in the coupling performance tables apply to uniform load conditions at constant speed where there is no misalignment or axial displacement.
- The torque capacity of flexible couplings will reduce when acceleration is present, for example, in stop/start or reversing conditions.
- The more severe the acceleration, the greater reduction in torque capacity.
- Sliding couplings (Oldham and UniLat) are subject to a wear rate dependent on the number of cycles completed.

Peak torque must be greater than application torque x service factor

	Load					Duty (Hours/Day)				
	Steady State	Stop/Start	Reversing	Shock	Shock & Reversing	<1	1 - 2	3 - 5	6 - 12	>12
Huco Flex B	1.5	2.0	2.0	3.0	4.0	-	-	-	-	-
Huco Flex M	1.5	2.0	2.0	3.0	4.0	-	-	-	-	-
Huco Flex Ni	1.0	2.0	2.0	3.0	4.0	-	-	-	-	-
Huco Flex P	1.0	1.5	1.5	3.0	4.0	-	-	-	-	-
Huco Flex G	1.0	2.0	4.0	4.0	4.0	-	-	-	-	-
Huco MultiBeam	1.0	1.5	2.0	(Note 1)	(Note 1)	-	-	-	-	-
Huco S-Beam	1.0	1.5	2.0	(Note 1)	(Note 1)	-	-	-	-	-
Huco TorqLink	1.0	1.5	2.0	(Note 1)	(Note 1)	-	-	-	-	-
Huco Oldham	-	-	-	-	-	1.0	2.0	4.0	6.0	8.0
Huco Flex - B	-	-	-	-	-	1.0	1.5	2.0	3.0	4.0
Uni-Lat	-	-	-	-	-	1.0	1.5	2.0	3.0	4.0

Note 1: Not recommended in these conditions

How to Order

All shaft mounted products in this catalogue can be specified with inch and/or metric bore diameters. A standard range of sizes is listed for each product. Where physical dimensions permit, keyways may be specified at extra cost.

For the sake of uniformity and avoidance of errors when ordering, bore diameters are designated with a 2-digit number which forms part of the order code.

Please note that only the bore diameters listed for each

product in the product pages are standard.

The table below lists the 2-digit designations for bore diameters spanning 1mm to 38mm and includes the metric equivalents for bores conforming to inch sizes. The columns at the right of the table show the key dimensions for the related bores. Designations for keywayed bores are shown in the last column.

To specify a **keywayed** bore, prefix the 2-digit

number with a 'P' for metric keyways or an 'R' for an inch keyway.

Standard keyways are machined to 2 specifications:

Bore codes prefixed 'P' denote a metric keyway conforming to

ISO 773/774 (BS 4235 Pt. 1).

Bore codes prefixed 'R' denote an inch keyway conforming

to BS 46 Pt. 1.

In most cases, keyways prefixed 'R' are compatible with AGMA 9002-A86 but can differ in the depth of the key seat. Shafts fitted with AGMA keys should be measured to determine dimension K and the key width. If these do not conform to the values shown in the table, please photocopy this page and enter the required dimensions on the drawing below.

Please enter all three dimensions, key width, shaft diameter and dimension K.

Round & Keywayed Bore Details & Codes

Metric mm	Inch fraction	Inch decimal	Round bore code	Metric keys		Inch keys		Keywayed bore code
				Key size w x h	K	Key size w x h	K	
1	–	0.0394	08	–	–	–	–	–
1.588	1/16	0.0625	10	–	–	–	–	–
2	–	0.0787	11	–	–	–	–	–
2.286	–	0.0900	12	–	–	–	–	–
2.382	3/32	0.0938	13	–	–	–	–	–
3	–	0.1181	14	–	–	–	–	–
3.048	–	0.1200	15	–	–	–	–	–
3.175	1/8	0.1250	16	–	–	–	–	–
*3.969	5/32	0.1563	–	–	–	–	–	–
4	–	0.1575	18	–	–	–	–	–
4.763	3/16	0.1875	19	–	–	–	–	–
5	–	0.1969	20	–	–	–	–	–
5.556	7/32	0.2188	21	–	–	–	–	–
6	–	0.2362	22	–	–	–	–	–
6.096	–	0.2400	23	–	–	–	–	–
6.350	1/4	0.2500	24	–	–	–	–	–
7	–	0.2756	25	2 x 2	8.00	–	–	P25
7.144	9/32	0.2813	26	–	–	–	–	–
7.938	5/16	0.3125	27	–	–	1/8 x 1/8	0.3755	R27
8	–	0.3150	28	2 x 2	9.00	–	–	P28
8.731	11/32	0.3438	29	–	–	1/8 x 1/8	0.4068	R29
9	–	0.3543	30	3 x 3	10.40	–	–	P30
9.525	3/8	0.3750	31	–	–	1/8 x 1/8	0.4380	R31
10	–	0.3937	32	3 x 3	11.40	–	–	P32
11	–	0.4331	33	4 x 4	12.80	–	–	P33
11.113	7/16	0.4375	34	–	–	1/8 x 1/8	0.5005	R34
12	–	0.4724	35	4 x 4	13.80	–	–	P35
12.700	1/2	0.5000	36	–	–	1/8 x 1/8	0.5630	R36
13	–	0.5118	37	5 x 5	15.30	–	–	P37
14	–	0.5512	38	5 x 5	16.30	–	–	P38
14.288	9/16	0.5625	39	–	–	3/16 x 3/16	0.6535	R39
15	–	0.5906	40	5 x 5	17.30	–	–	P40
15.875	5/8	0.6250	41	–	–	3/16 x 3/16	0.7160	R41
16	–	0.6299	42	5 x 5	18.30	–	–	P42
17	–	0.6693	43	5 x 5	19.30	–	–	P43
17.463	11/16	0.6875	44	–	–	3/16 x 3/16	0.7785	R44
18	–	0.7087	45	6 x 6	20.80	–	–	P45
19	–	0.7480	46	6 x 6	21.80	–	–	P46
19.050	3/4	0.7500	47	–	–	3/16 x 3/16	0.8410	R47
20	–	0.7874	48	6 x 6	22.80	–	–	P48
22	–	0.8661	49	6 x 6	24.80	–	–	P49
22.225	7/8	0.8750	50	–	–	1/4 x 1/4	0.9930	R50
24	–	0.9449	51	8 x 7	27.30	–	–	P51
25	–	0.9843	52	8 x 7	28.30	–	–	P52
25.400	1	1.0000	53	–	–	1/4 x 1/4	1.1180	R53
28	–	1.1024	54	8 x 7	31.30	–	–	P54
28.575	1-1/8	1.1250	55	–	–	5/16 x 1/4	1.2400	R55
30	–	1.1811	56	8 x 7	33.30	–	–	P56
31.750	1-1/4	1.2500	57	–	–	5/16 x 1/4	1.3580	R57
32	–	1.2598	58	10 x 8	35.30	–	–	P58
34.925	1-3/8	1.3750	59	–	–	3/8 x 1/4	1.4830	R59
35	–	1.3780	60	10 x 8	38.30	–	–	P60
38	–	1.4961	61	10 x 8	41.30	–	–	P61

*Not manufactured. Nearest alternative 4mm.

Order Codes

Combine the COUPLING REF in Main Product Tables with BORE REFS in Standard Bores Table.

Please identify both bores e.g.

706.19.1924

Coupling ref.

Ø B1 ref.

Ø B2 ref.

Installing Couplings

Flexible Coupling Types

General instructions

1. Ensure that shafts are free of burrs, damage, or foreign matter, and can penetrate the bores.
2. Install the coupling by holding the shaft and the related hub, rotating it back and forth as you progress it along the shaft.
3. Do not apply any forces that cause extension, compression or lateral displacement of the coupling beyond its permissible offsets.

Normal installation

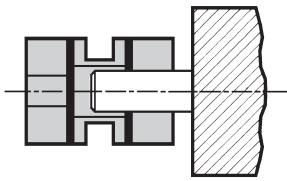

- a) Position and secure the larger of the 2 shafts (if different) and progress the coupling onto it.

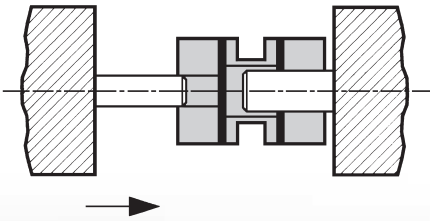

- b) Progress the second shaft into the bore, taking care not to lever either shaft against the inner wall of the spacer.

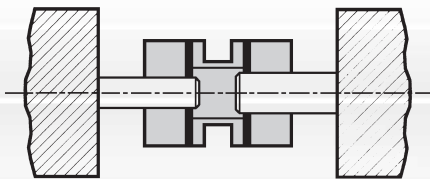

- c) Progress the coupling along the shafts to a position midway between the shaft terminations. Rotate the coupling to ensure it is not binding and is in its natural state, ie., neither extended nor compressed.
- d) Align the second shaft with the first using a straight edge and feeler gauges or a dial indicator.
- e) Secure the second shaft and re-check alignment. Final alignment must be within the permissible offsets.
- f) Secure one hub, tightening each screw alternately. Repeat for the second hub.

When to use single & two-stage couplings

Single-stage

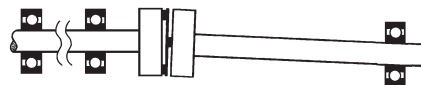

Example 1. With partially supported (1 bearing) shafts.

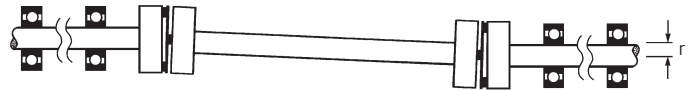

Example 2. With unsupported intermediate shafts.

Single-stage couplings are radially supportive and function as supplementary bearings. They are used when the connected shaft lacks a full complement of bearings.

Two-stage



Two-stage couplings are radially compliant and are used when both shafts are fully supported by bearings.

CAUTION

These are precision high couplings that have a limited range of permissible flexure. They can be damaged through careless handling. Avoid gratuitous flexure in any direction.

No axial forces are permitted across the membranes when fitting Huco-Flex M couplings. Keyways with interference fits are not recommended.

Bellows couplings are more tolerant of axial motion, but flexure beyond the permissible limits should be avoided.

Note: Bellows couplings do not provide the same level of radial support as Flex M when used with partially or wholly unsupported shafts. When essential for reasons of greater axial motion, use the 3-convolution type for these purposes.

Installing Couplings

Sliding Disc type (Oldham)

Blind hub

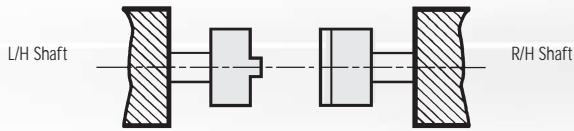

- Slide hubs on to both shafts until fully seated and tighten screws.
- Position and secure R/H shaft.

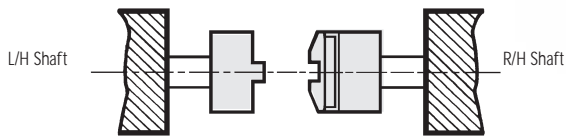

- Seat disc fully on R/H hub.

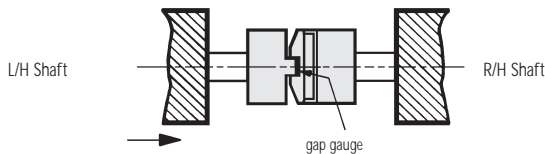

- Place a gap gauge flat against the bottom of the exposed slot in the disc and push the L/H hub into full engagement by manipulating the L/H shaft.
 - Align shafts within the permissible offsets and secure L/H shaft.
 - Check alignment and correct if necessary.
 - Remove gap gauge.
- To fit a new disc, withdraw L/H shaft complete with hub and remove old disc. Repeat steps c) to g).

Gap gauges for all hub types

Coupling size	Gap gauge
06, 09 & 13	0.05mm
19 & 25	0.10mm
33 & 41	0.15mm
50 & 57	0.20mm

Clearances are set to allow for thermal shaft growth and / or end-float. Gaps may be increased, but total shaft movement should not exceed the values shown under *Axial Compensation* in the Performance Table.

Radial support

Shafts must be fully supported by 2 bearings and have minimal overhang. Oldham couplings cannot be used in pairs.

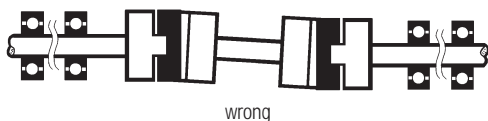

Note: It is important that installed couplings are not end-loaded. To help avoid this, thro' bored hubs are recommended for shafts which have fixed axial locations such as face-mounted motors.

Thro' hub

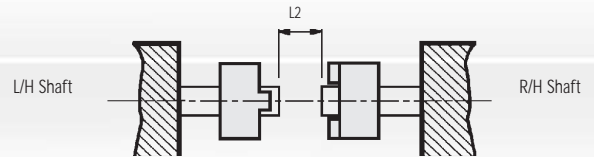

- Slide hubs on to both shafts.
- Align shafts to within the permissible offsets and position to leave *minimum* gap 2 between terminations. Secure both shafts, check alignment and correct if necessary.

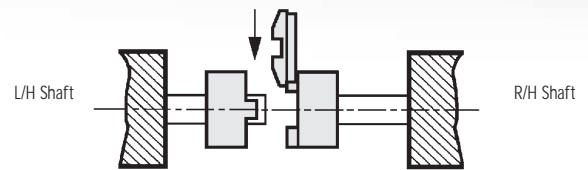

- Position R/H hub with inboard face flush with shaft termination and tighten screws.
- Slide disc radially on to the tenons of the R/H hub. Ensure the disc is fully seated.

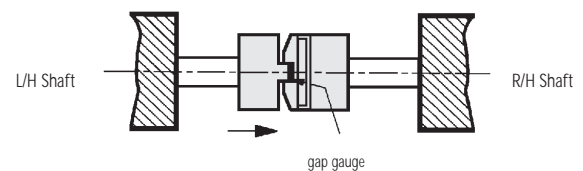

- Place a gap gauge flat against the bottom of the exposed slot in the disc and push the L/H hub into full engagement.
- Tighten fastening screws and remove gap gauge.

To fit a new disc, slacken the fastening screws on one hub and retract it along the shaft. Slide the old disc out radially and replace with the new. Repeat steps d) to f).

To retain shaft phasing, withdraw L/H shaft and repeat steps c) to g) as for Blind hub couplings.

Over-penetration of shafts can impair function of coupling with solid disc. Min shaft gap L2 must be observed. Specify thro' bored disc for near-butted shafts.

Coupling size	19	25	33	41	50	57
L2 min	7.2	9.2	12.0*	15.3	18.4	21.2

*types 243, 245, 454 and 456 = 18.0

Clamp hubs

To improve clamp action, apply a little grease under the head of the clamp screw.

Installing Couplings

Beam Type

Relief Under The Beams

Most Multi-Beam couplings can be supplied with or without relief under the beams as shown in the diagrams below. When the drive or driven shafts extend under the beams relief is essential to ensure that the coupling remains flexible. Where non-relieved versions are used, shafts must not be allowed to penetrate under the beamed section of the coupling. Unless otherwise specified, relieved versions will be supplied.

Pilot Bores

Couplings can be supplied 'pilot bored' for opening out by the customer. Pilot bores are plain drilled holes, which are not produced with the same accuracy as finished machined bores. The largest bore provided in a pilot bored product is that needed to make the coupling flexible and this will always be larger than the minimum possible bore size 'B1' shown in the bore tables. For sizes 13 to 25, the pilot bore is also larger than the 'B2' minimum shown in the bore tables. Further details are available on request.

Non-Relieved

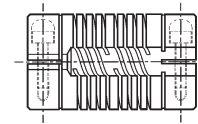
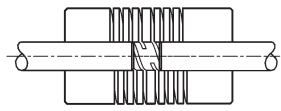
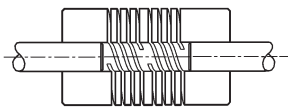

Relieved

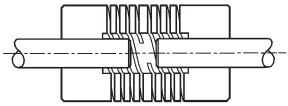

high performance couplings

- Stainless Steel Bellows
- Nickel Bellows
- Flexible Membrane (Disc)

- Torsionally rigid design
- No moving parts
- All-metal construction
- Low inertia

The operating principles of Flex B, Flex Ni and Flex M offer the highest performance available with flexible couplings.

With excellent kinematic properties and torsional stiffness of a very high order, they are suitable for servo drives and satisfy the criteria for highly dynamic position and velocity control systems.

Bellows couplings have the greater torsional stiffness while Flex M have the more tolerant flexural system and feature dynamically balanced construction.





Set screw hubs

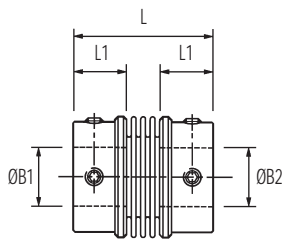

Ref. 530
Short type
for precisely aligned shafts

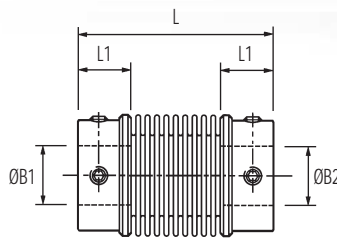

Ref. 532
Long type
for greater angular offsets
or axial motion

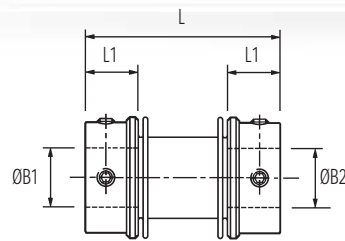

Ref. 534
Stretched type
for greater radial misalignment
and lower bearing loads

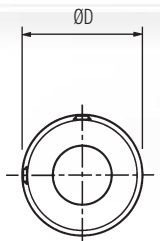

Typical

Clamp hubs

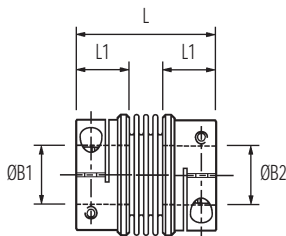

Ref. 536 & 537
Short type
for precisely aligned shafts

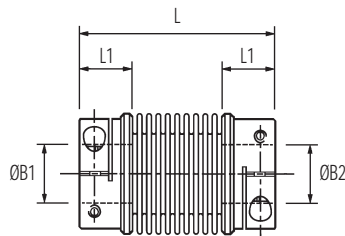

Ref. 538 & 539
Long type
for greater angular offsets
or axial motion

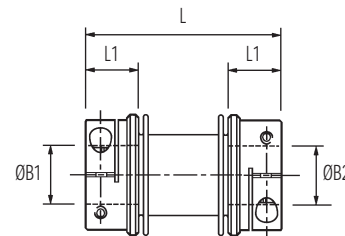

Ref. 540 & 541
Stretched type
for greater radial misalignment
and lower bearing loads

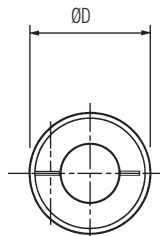

Typical

12

Comparative properties

The properties of the 3 types compared on a scale of 1 to 3. 3 = best.

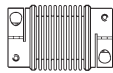
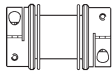
	Short	Long	Stretched
Parameter			
Peak Torque	2	1	3
Torsional Stiffness	3	1	2
Angular Compensation	2	3	1
Axial Compensation	2	3	1
Radial Compensation	1	3	2

Materials & Finishes

Hubs: Al. Alloy 2014T6 and AlEco 62sn T9 Clear anodised finish

Bellows: Spring quality stainless steel

Joint assembly: Copper C106, heat treated Zinc plate, clear passivate

Fasteners: Alloy steel, black oiled

Temperature Range

-40°C to +120°C

Flex - B Stainless Steel Bellows Couplings



DIMENSIONS & ORDER CODES

Coupling Size	Set Screw Hubs	Clamp Hubs	ØD	L	¹ L1	ØB1, ØB2 max	Fasteners			³ Moment of inertia kgm ² x 10 ⁻⁸	³ Mass kg x 10 ⁻³
							Screw	² Torque Nm	Wrench mm		
20	530.20	-	20.0	±1.0	11.0	8	M4	2.27	2	90	18
	532.20	-		100						19	
	534.20	-		90						18	
	-	537.20		90						16	
	-	539.20		100						18	
	-	541.20		90						17	
26	530.26	-	26.0	±1.0	14.0	12	M5	4.62	2.5	350	35
	532.26	-		400						39	
	534.26	-		370						34	
	-	536.26		330						34	
	-	538.26		380						38	
	-	540.26		350						33	
34	530.34	-	34.0	±1.0	14.0	16	M5	4.62	2.5	975	58
	532.34	-		1128						65	
	534.34	-		988						59	
	-	536.34		925						56	
	-	538.34		1078						63	
	-	540.34		938						57	
41	530.41	-	41.0	±1.0	18.0	20	M6	7.61	3	2490	102
	532.41	-		2740						110	
	534.41	-		2477						102	
	-	536.41		2390						99	
	-	538.41		2660						107	
	-	540.41		2377						99	

IMPORTANT

Load capacity depends on application conditions: see page 6 for details

PERFORMANCE

Coupling Size	Ref.	⁴ Peak torque Nm	⁵ Max compensation			⁶ Flexural stiffness			
			Angular deg	Radial mm	Axial ± mm	Torsional Nm / rad	Angular N / deg	Radial N / mm	Axial N / mm
20	530 & 537	2.0	2	0.06	0.35	315	1.03	115	17.7
	532 & 539	1.0	6	0.50	1.00	170	0.33	6.7	7.8
	534 & 541	2.5	1.3	0.20	0.20	225	0.33	8.2	7.1
26	530 & 536	3.2	2	0.06	0.36	755	1.27	238	5.7
	532 & 538	1.6	6	0.50	1.00	380	0.39	8.2	3.3
	534 & 540	4.0	1.3	0.20	0.20	615	1.52	14.6	6.4
34	530 & 536	7.5	2.5	0.10	0.60	1740	1.34	227	6.6
	532 & 538	3.8	8	1.00	1.90	915	0.62	12.7	3.8
	534 & 540	9.4	1.5	0.30	0.30	1455	1.98	23.2	27.9
41	530 & 536	10.0	2.5	0.15	0.80	2880	1.58	144	13.1
	532 & 538	5.0	8	1.20	2.50	1310	0.52	9.3	3.8
	534 & 540	12.5	1.8	0.40	0.50	2245	2.30	19.2	7.2

- Length of supported thro' bore. Shafts can near-butt.
- Maximum recommended tightening torque.
- Values apply with max bores.
- Peak torque. Select a size where Peak Torque exceeds the application torque x service factor. (see page 6)
- Max. compensation values are mutually exclusive.
- Torsional stiffness values apply at 50% peak torque with no misalignment, measured shaft-to-shaft with largest standard bores. Note that in some vendors' catalogues the given torsional stiffness applied to the un-mounted bellows element only, an unrepresentative calculated value.

STANDARD BORES

Coupling Size	ØB1, ØB2 +0.03/-0mm																					
	3	3.175	4	4.763	5	6	6.350	8	9	9.525	10	11	12	12.700	14	15	15.875	16	18	19	19.050	20
20	●	●	●	●	●	●	●															
26			●	●	●	●	●	●	●	●	●	●	●									
34						●	●	●	●	●	●	●	●	●	●	●	●	●	●	●	●	●
41							●	●	●	●	●	●	●	●	●	●	●	●	●	●	●	●
Bore ref.	14	16	18	19	20	22	24	28	30	31	32	33	35	36	38	40	41	42	45	46	47	48
Corresponding bore adaptor					251		253	255			257			259				260				261

Diameters for which a bore adaptor is shown can be adapted to smaller shaft sizes. See page 56 for details of metallic and electrically insulating adaptors.



Set Screw Hubs

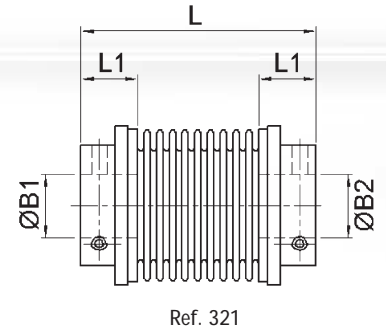
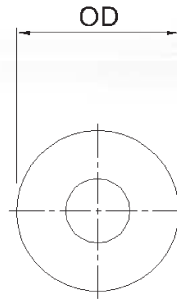
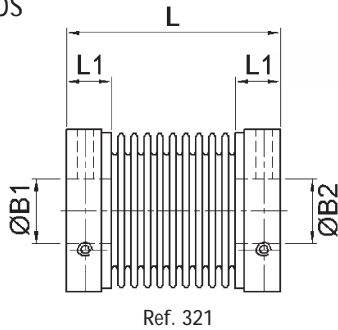

Clamp Hubs

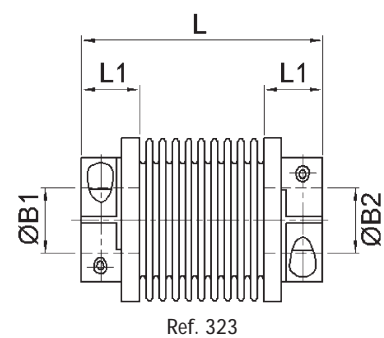
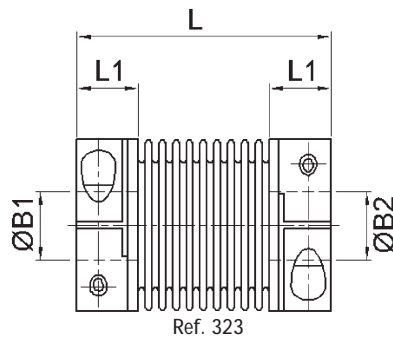

The convolutions of Flex-Ni Couplings are formed by the electrolytic deposition of nickel. This produces stress-free convolutions with closely controlled wall thickness.

Nickel bellows couplings are characterised by their exceptional quality of rotational positional integrity. This is achieved through high torsional stiffness in a coupling that is still able to accommodate large amounts of lateral and angular misalignment due to low spring rates in these directions. These couplings are used primarily in instrumentation and similar sensitive applications.

Materials & Finishes

Hubs: Aluminium Alloy

Bellows: Electrodeposited nickel

Fasteners: Alloy steel

Temperature Range

-50°C to +120°C



DIMENSIONS & ORDER CODES

Size	Number of convolutions	Order Code		Dimensions						Fasteners		
		Set Screw Hub	Clamp Hub	O.D	O/A Length L	Max Shaft Depth L1	Max Bores	Moment of Inertia kgm ² x 10 ⁻⁸	Mass kg x 10 ⁻³	Size	Torque (Ncm)	A/F (mm)
7	8	321.07	-	6.35	14	4	3.175	1.3	1.5	M2	41	0.9
12	14	321.12	-	12	23	6	6.35	18.5	10	M2.5	79	1.3
17	14	321.17	-	17	27	7	10	36.2	8.5	M3	132	1.5
		-	323.17	16.3	29	8	6.35	46.6	11.0	M2	35	1.5
25	10	321.25	-	25	33	7	12.7	161.0	19.5	M3	132	1.5
		-	323.25	25	37	9	12.7	245.0	28.5	M2.5	66	2.0
36	7	321.36	-	36.3	42.3	9.5	19.05	601.0	39.0	M6	510	3.0
		-	323.36	36.3	46.9	11.8	19.05	2960.0	85.0	M4	262	3.0
50	11	321.50	-	51	59.3	10.5	20	952.0	52.0	M6	860	3.0
		-	323.50	51	61.9	11.8	20	3560.0	105.0	M4	262	3.0

PERFORMANCE

Size	Peak Torque (Ncm)	Wind up Arcs/Ncm	Max misalignment compensation			Nominal Spring Rates			
			Angular Deg	Radial mm	Axial mm	Torsional (Nm/rad)	Angular (N/deg)	Radial (N/mm)	Axial (N/mm)
7	4.9	285	10	0.19	0.65	7	<0.15	6.9	3.5
12	13	75	15	0.54	1.72	27	<0.15	4.2	2.2
17	50	20	10	0.43	1.78	103	0.15	12.3	4.0
25	328	4.0	8	0.46	2.07	515	0.41	38.1	11.2
36	918	1.2	6	0.46	3.28	1719	0.32	87.8	20.2
50	1624	0.6	9	1.12	6.1	3438	<0.15	57.8	17.6

15

AVAILABLE BORES

Size	Ø B1, B2 H8															
	3	3.175	4	4.763	5	6	6.350	8	9.525	10	12	12.700	16	19.050	20	
7	•	•	•													
12	•	•	•	•	•	•	•									
17	•	•	•	•	•	•	•	S	S	S						
25						•	•	•	•	•	•	•				
36										•	•	•	•			
50											•	•	•	•	•	
Bore Ref.	14	16	18	19	20	22	24	28	31	32	35	36	42	47	48	

S = Setscrew only

IMPORTANT
Load capacity depends on application conditions: see page 6 for details



Set screw hubs

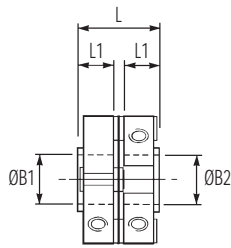

Ref. 460
for use in pairs or with floating shafts

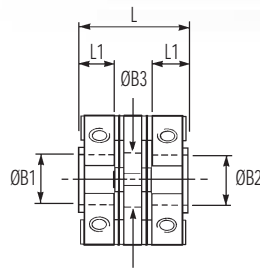

Ref. 464
for precisely aligned shafts

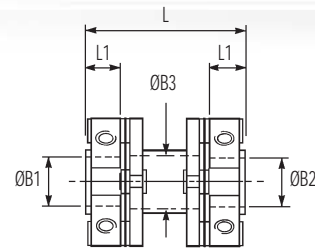

Ref. 468
for greater radial misalignment and lower bearing loads

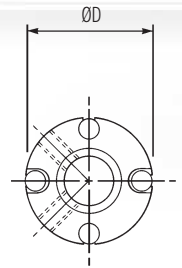

Typical

Clamp hubs

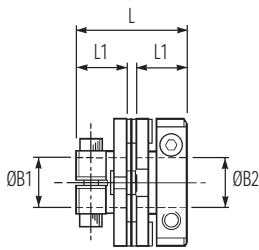

Ref. 462
for use in pairs or with floating shafts

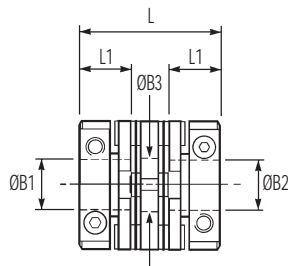

Ref. 466
for precisely aligned shafts

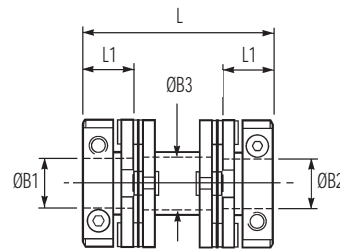

Ref. 470
for greater radial misalignment and lower bearing loads

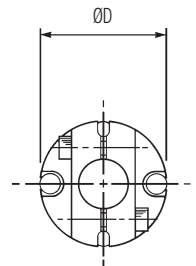

Typical

16

Drive shafts

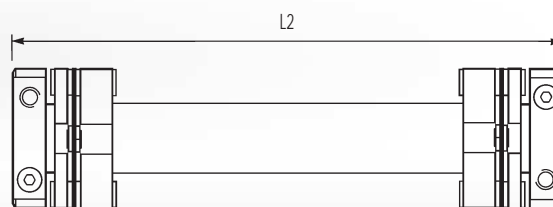

Unless specified otherwise, drive shafts are supplied with set screw hubs inboard.

Drive shafts are supplied to order.

Please specify:

- Coupling size
- Hub style and bore diameter at each end
- Keyway details
- Overall length L2
- Minimum torsional stiffness, if critical
- Quantity

Materials & Finishes

Hubs & spacer: Al. Alloy 7020T6
Clear anodised finish

Membranes: Spring quality stainless steel
Heat treated

Rivet assembly: Brass rivets flanked by formed steel washers
Steel, zinc plate & colour passivate

Fasteners: Alloy steel, black oiled

Temperature Range

-40°C to +120°C

Flex - M Flexible Membrane Couplings - Rivetted Series



DIMENSIONS & ORDER CODES

Coupling Size	Set Screw Hubs	Clamp Hubs	ØD	L	¹ L1	ØB1, ØB2 max	² ØB3	Fasteners			⁴ Moment of inertia kgm ² x 10 ⁻⁸	⁴ Mass kg x 10 ⁻³
								Screw	³ Torque Nm	Wrench mm		
COUPLING REF												
19	460.19	-	19.2	13.0	5.6	6.35	N/A	M3	0.94	1.5	30	7
	464.19	-		19.6			7.3				50	10
	468.19	-		27.3			N/A				60	12
	-	462.19		20.2	7.3		40	9				
	-	466.19		26.8	M2.5		1.32	2	60	13		
	-	470.19		34.5	N/A		60	14				
26	460.26	-	25.6	15.8	6.9	10	N/A	M4	2.27	2	120	15
	464.26	-		22.4			11.0				160	18
	468.26	-		30.1			N/A				200	23
	-	462.26		21.8	11.0		130	16				
	-	466.26		28.4	M2.5		1.32	2	160	20		
	-	470.26		36.1	N/A		210	25				
33	460.33	-	33.5	22.5	10.0	12.7	N/A	M5	4.62	2.5	560	37
	464.33	-		32.1			14.1				800	52
	468.33	-		42.8			N/A				830	55
	-	462.33		30.5	14.1		520	37				
	-	466.33		40.1	M3		2.43	2.5	730	51		
	-	470.33		50.8	N/A		760	55				
41	460.41	-	41.5	27.1	12.0	16	N/A	M6	7.61	3	1540	69
	464.41	-		38.5			17.5				2250	97
	468.41	-		50.1			N/A				2450	107
	-	462.41		37.1	17.5		1530	72				
	-	466.41		48.5	M4		5.66	3	2220	100		
	-	470.41		60.1	N/A		2370	109				

IMPORTANT

Load capacity depends on application conditions: see page 6 for details

PERFORMANCE

Coupling Size	Ref.	⁵ Peak torque Nm	⁷ Max compensation			⁷ Flexural stiffness			
			Angular deg	Radial mm	Axial ± mm	Torsional Nm / rad	Angular N / deg	Radial N / mm	Axial N / mm
19	460 & 462	0.9	2	0	0.1	220	0.4	-	< 7
	464 & 466		4	0.2	0.2	150	0.25	14	
	468 & 470		4	0.4	0.2	145	0.3	4	
26	460 & 462	2.3	2	0	0.1	585	0.75	-	< 7
	464 & 466		4	0.2	0.2	385	0.5	37	
	468 & 470		4	0.4	0.2	400	0.4	7	
33	460 & 462	5.6	1.5	0	0.1	1560	2	-	< 8
	464 & 466		3	0.2	0.2	935	1	48	
	468 & 470		3	0.4	0.2	980	1.2	13	
41	460 & 462	11.3	1	0	0.1	2710	4	-	< 8
	464 & 466		2	0.2	0.2	1980	2	100	
	468 & 470		2	0.4	0.2	2020	2	25	

- Length of supported thro' bore.
- Clearance bore thro' spacer.
- Maximum recommended tightening torque.
- Values apply with max bores.
- Peak torque. Select a size where Peak Torque exceeds the application torque x service factor. (see page 6)
- Max. compensation values are mutually exclusive.
- Torsional stiffness values apply at 50% peak torque with no misalignment, measured shaft-to-shaft with largest standard bores.
Note that in some vendors' catalogues the given torsional stiffness applies to the membrane stack only, giving rise to a greater value.

STANDARD BORES

Coupling Size	ØB1, ØB2 +0.03/-0mm																		
	3	3.175	4	4.763	5	6	6.350	8	9	9.525	10	11	12	12.700	14	15	15.875	16	
19	●	●	●	●	●	●	●												
26			●	●	●	●	●	●	●	●	●								
33						●	●	●	●	●	●	●	●	●					
41							●	●	●	●	●	●	●	●	●	●	●	●	●
Bore ref.	14	16	18	19	20	22	24	28	30	31	32	33	35	36	38	40	41	42	
Corresponding bore adaptor					251		253	255				257		259					260

Diameters for which a bore adaptor is shown can be adapted to smaller shaft sizes. See page 56 for details of metallic and electrically insulating adaptors.



Set screw hubs

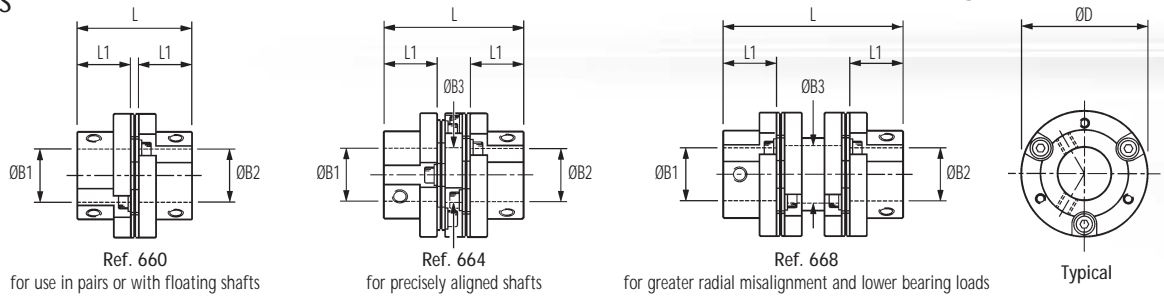

Clamp hubs

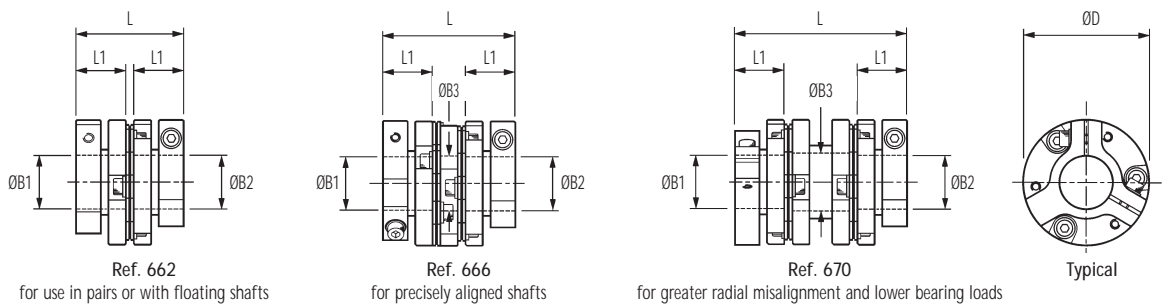

Drive shafts

Unless specified otherwise, drive shafts are supplied with set screw hubs inboard and/or bonded to link shaft.

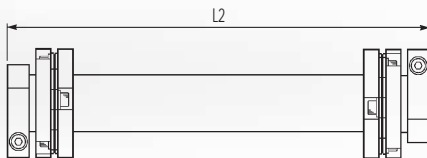

Drive shafts are supplied to order.

Please specify: • Coupling size • Hub style and bore diameter at each end • Keyway details • Overall length L2 • Minimum torsional stiffness, if critical • Quantity

Materials & Finishes

Hubs & spacer: Al. Alloy 2014A T6 or AIECO 62 Sn T9
BS 4300/5 FC1
Clear anodised finish

Membranes: Spring quality stainless steel
Heat treated

Bolt assembly: Bolt, alloy steel, black oiled finish
Bush assembly, steel, zinc plate & black chromate
Safety washer, carbon steel, black/brown oiled finish

Fasteners: Alloy steel, black oiled

Temperature Range

-40°C to +120°C

Flex - M Flexible Membrane Couplings - Bolted Series



DIMENSIONS & ORDER CODES

Coupling Size	Set Screw Hubs	Clamp Hubs	ØD	L	¹ L1	ØB1, ØB2 max	² ØB3	Fasteners			⁴ Moment of inertia kgm ² x 10 ⁻⁸	⁴ Mass kg x 10 ⁻³
								Screw	³ Torque Nm	Wrench mm		
COUPLING REF												
41	660.41	=	41.5	36.9	17.1	16	N/A	M6	7.60	3	1160	63
	664.41	-		47.9			16.8				1680	90
	668.41	-		59.7			17.5				1790	101
	-	662.41		36.9			N/A				1400	74
	-	666.41		47.9			16.8				2010	101
	-	670.41		59.7			17.5				2250	112
52	660.52	-	52.0	44.2	22.9	20	N/A	M6	7.60	3	3740	124
	664.52	-		55.0			22.0				5490	168
	668.52	-		72.4			N/A				6840	208
	-	662.52		50.0			N/A				5660	164
	-	666.52		60.8			22.0				7470	208
	-	670.52		78.1			22.0				8870	247
66	660.66	-	66.0	60.4	26.0	28	N/A	M8	18.3	4	13370	272
	664.66	-		73.6			28.7				18040	360
	668.66	-		94.7			30.2				23400	447
	-	662.66		56.4			N/A				14200	269
	-	666.66		69.6			28.7				19300	357
	-	670.66		90.7			30.2				24320	444

IMPORTANT

Load capacity depends on application conditions: see page 6 for details

PERFORMANCE

Coupling Size	Ref.	⁵ Peak torque Nm	⁶ Max compensation			⁷ Flexural stiffness			
			Angular	Radial	Axial	Torsional	Angular	Radial	Axial
			deg	mm	± mm	Nm / rad x 10 ³	N / deg	N / mm	N / mm
41	660 & 662	11.3	1	0	0.1	4.0	3.7	-	-
	664 & 666		2	0.2	0.2	2.8	1.6	97	< 8
	668 & 670		2	0.4	0.2	2.6	1.6	23	< 8
52	660 & 662	30	1	0	0.1	7.5	10.0	-	-
	664 & 666		2	0.2	0.2	4.8	5.0	313	< 9
	668 & 670		2	0.4	0.2	4.8	5.0	57	< 9
66	660 & 662	60	1	0	0.1	19.0	84.0	-	-
	664 & 666		2	0.2	0.2	12.0	23.0	379	< 9
	668 & 670		2	0.4	0.2	12.0	23.0	93	< 9

- Length of supported thro' bore.
- Clearance bore thro' spacer.
- Maximum recommended tightening torque.
- Values apply with max bores.
- Peak torque. Select a size where Peak Torque exceeds the application torque x service factor. (see page 6)
- Max. compensation values are mutually exclusive.
- Torsional stiffness values apply at 50% peak torque with no misalignment, measured shaft-to-shaft with largest standard bores. Note that in some vendors' catalogues the given torsional stiffness applies to the membrane stack only, giving rise to a greater value.

Note that the drawings on the facing page represent Size 66 which employ 6-bolt membrane attachment and have 3-lobed clamp hubs.

Sizes 41 & 52 employ 4-bolts and have clamp hubs similar to those of the rivetted series

STANDARD BORES⁸

Coupling Size	ØB1, ØB2 +0.03/-0mm																			
	6.350	8	9	9.525	10	11	12	12.700	14	15	15.875	16	18	19	19.050	20	24	25	25.400	28
41	●	●	●	●	●	●	●	●	●	●	●	●	●	●	●	●				
52		●	●	●	●	●	●	●	●	●	●	●	●	●	●	●				
66							●	●	●	●	●	●	●	●	●	●	●	●	●	●
Bore ref.	24	28	30	31	32	33	35	36	38	40	41	42	45	46	47	48	51	52	53	54
Corresponding bore adaptor	253	255			257			259				260				261			262	263

Diameters for which a bore adaptor is shown can be adapted to smaller shaft sizes. See page 56 for details of metallic and electrically insulating adaptors.

You can now...

Download or order catalogues

•
Download our *Designer's Guide to Precision Shaft Couplings*

•
Find a distributor in your area

•
Read the latest product news

•
Browse detailed information on all Huco products

•
Search for products by order code or keyword

20



@

www.huco.com

general purpose motion control couplings

- Universal Lateral (Uni-Lat)
- Sliding Disc (Oldham)

- Backlash-free up to 10^8 turns
- Can tolerate large misalignments
- Slight damping characteristics
- Flex-free mechanical action
 - non-progressive bearing loads
- Non-magnetic (with special screws)
- Electrically isolating
- Low inertia

Uni-Lats are widely used for pulse generator drives while Oldhams are very popular for stepper driven positioning stages.

A unique property of Uni-Lats is resistance to axial motion. This makes them suitable for light push/pull duties and for anchoring axially unrestricted shafts.

Oldhams are 3-part couplings consisting of 2 hubs + 1 torque disc. The hubs determine the method of installation and shaft attachment, the discs determine the quality of motion.

The 4 hub styles and 2 disc materials that comprise the range are fully interchangeable within each of the 9 sizes available. To take advantage of this flexibility, hubs and discs are specified and supplied separately.

The discs are the sacrificial elements and are replaceable at low cost in the event of wear or breakage.





Set screw hubs

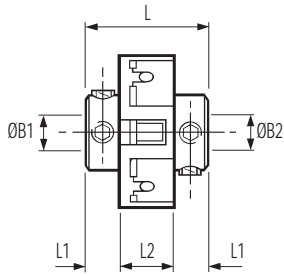

Ref. 201
Small bores

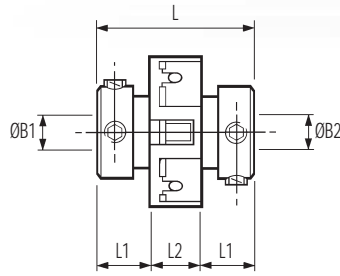

Ref. 203
Large bores

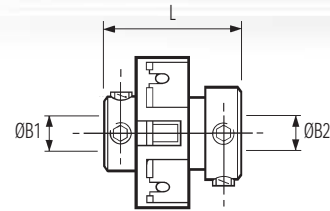

Ref. 221 (not listed in main table).
Combines large & small bores.
See explanatory note on facing page

Coupling ref. 221

Size	L
18	16.7
27	22.3
34	28.0
41	33.3

Clamp hubs

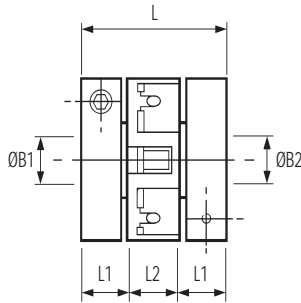

Ref. 207
Collet hub & ring clamp

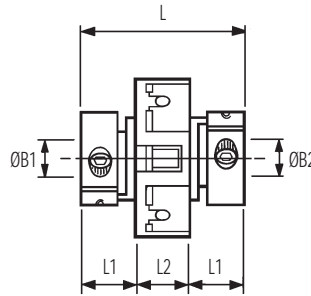

Ref. 205, 206
Integral leaf clamp

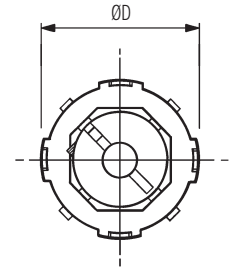

Typical

22

Installation

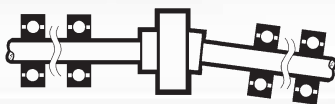

right

Up to 10° angular offset,
depending on type

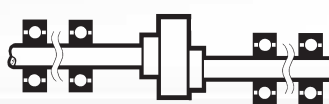

right

Up to 1mm radial offset for
extreme misalignments

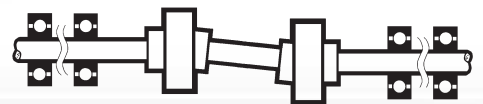

wrong

Standard Uni-Lats cannot be used in pairs.
Special versions are available for use in this mode.
Please enquire.

Materials & Finishes

Hub sizes 18 & 27: Brass BS 2874 CZ121

Hub sizes 34 & 41: Al. Alloy AIECO 62Sn T9
Irridite NCP

Fasteners: Alloy steel, black oiled

Clamp rings (sizes 18 & 27):
Al. Alloy AIECO 62Sn T9
Irridite NCP

Torque rings, all sizes: Acetal (black)

Temperature Range

-20°C to +60°C

Uni-Lat Universal / Lateral Offset Couplings



DIMENSIONS & ORDER CODES

Coupling Size	Set Screw Hubs	Clamp Hubs	ØD	L	1 L1	2 L2	ØB1, ØB2 max	Fasteners			4 Moment of inertia kgm ² x 10 ⁻⁸	4 Mass kg x 10 ⁻³
								Screw	3 Torque Nm	Wrench mm		
COUPLING REF												
18	201.18	-	18.0	14.2	4.6	5.1	5	M3	0.94	1.5	20	7
	203.18	-		19.1	7.0		6.35					
	-	207.18 ‡ 219	19.1	-	-	-	4-40	2.33	2.0	55	11	
27	201.27	-	28.0	19.1	6.1	6.9	8	M3	0.94	1.5	91	16
	203.27	-		25.4	9.3		10					
	-	207.27 ‡ 218	-	-	-	-	M3	2.43	2.5	220	26	
34	201.34	-	33.7	25.2	8.1	8.9	10	M4	2.27	2.0	165	17
	203.34	-		30.7	10.9		12.7					
	-	206.34	-	-	-	-	4-40	2.33	2.0	183	20	
41	201.41	-	41.4	28.4	8.6	11.2	12.7	M4	2.27	2.0	476	30
	203.41	-		38.1	13.5		16					
	-	205.41	-	-	-	-	12.7	M4	5.66	3.0	550	40
70	203.70	-	69.0	74.0	28.5	17.0	22	M6	7.60	3.0	7315	189
	-	205.70		-	-		-					

- Length of supported thro' bore. Shafts must not penetrate beyond L1 when in operation.
 - Nominal distance between shafts inserted to L1.
 - Maximum recommended tightening torque.
 - Values apply with max bores.
 - Peak torque. Select a size where Peak Torque exceeds the application torque x service factor. (see page 6)
 - Couplings can provide up to 1mm radial and 10° angular compensation (5° for ref. 207) when required. Observe given values for maximum backlash-free life. Electrical isolation between shafts > 3kV for all models when offset ≤5°.
 - Values apply at 50% peak torque with no misalignment, measured shaft-to-shaft with largest standard bores.
 - Momentary values.
- ‡ Ref. 207 only. Insert both bore codes in place of ‡.

PERFORMANCE AT 20°C

Coupling Size	5 Peak torque Nm	6 Max compensation @ 3000 r.p.m.		7 Torsional			Axial		Static break torque Nm
		Angular deg	Radial mm	Rate deg / Nm	Stiffness Nm / rad	8 Max loading ±N	Stiffness N / mm		
18	0.3	2	0.2	2.3	25	19	155	0.9	
27	1.7		0.2	0.6	92	31	350	5.0	
34	2.5		0.25	0.4	146	34	300	7.5	
41	3.5		0.25	0.19	299	39	250	10.5	
70	12.0		0.25	0.19	1300	75	540	68	

Coupling ref. 221

By specifying ref. 221 (not listed in tables, see diagram facing page) you can combine the bores coded for ref. 201 with those coded for ref. 203,

eg., 221.27.2432 specifies Size 27 with Ø6.35 x 10 bores.

IMPORTANT

Load capacity depends on application conditions: see page 6 for details

STANDARD BORES

Coupling		ØB1, ØB2 +0.03/-0mm																				
size	ref.	3	3.175	4	4.763	5	6	6.350	7.938	8	9.525	10	12	12.700	14	15.875	16	18	19	19.05	20	
18	201.18	●	●	●	●	●																
	203.18						●	●														
	207.18	●	●	●	●	●	●	●														
27	201.27	●	●	●	●	●	●	●	●	*	●											
	203.27										●	●										
	207.27					●	●	●		●	●	●										
34	201.34						●	●		●	●	●										
	203.34												●	●								
	206.34						●	●	●	●	●	●										
41	201.41						●	●		●	●	●	●	●								
	203.41														●	●	●					
	205.41						●	●		●	●	●	●	●								
70	203.70												●	●	●	●	●	●	●	●	●	●
	205.70												●	●	●	●	●	●	●	●	●	●
Bore ref.		14	16	18	19	20	22	24	27	28	31	32	35	36	38	41	42	45	46	47	20	
Corresponding bore adaptor						251		253		254*		257		259			260					261

Diameters for which a bore adaptor is shown can be adapted to smaller shaft sizes. See page 56 for details.

*Note that adaptor 254 is dedicated to coupling ref. 201.27. Use adaptor 255 for all other 8mm diameters.



Blind hubs

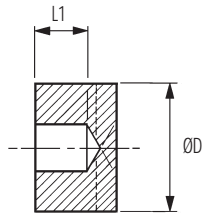

Controlled bore depth L1 provides a register when pre-assembling hubs to shafts

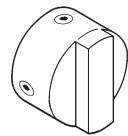

Set screw style



Clamp style

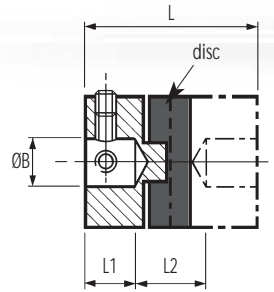

Refs. 232, 243
Set screw style

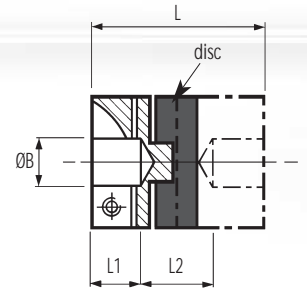

Refs. 234, 235, 245
Clamp style

Thro' hubs

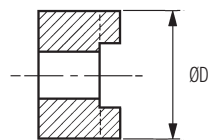

Thro' bores allow disc replacement without disturbing shaft alignment

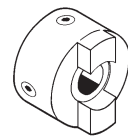

Set screw style

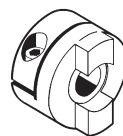

Clamp style

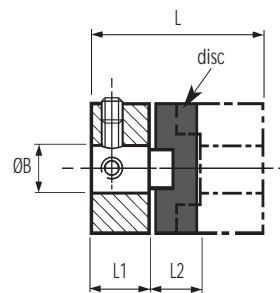

Refs. 450, 454
Set screw style

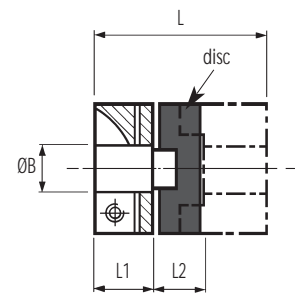

Refs. 452, 453, 456
Clamp style

Blank hubs

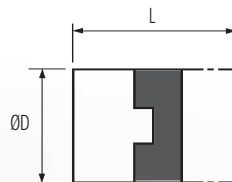

User-adaptable for special needs, e.g. fitting within tubes. Blank hubs are supplied centred with no provision for fastening. External dimensions identical with blind hubs.

Coupling size	Complete hub ref.	ØD	L
06	231.06.00	6.4	12.7
09	231.09.00	9.5	12.7
13	231.13.00	12.7	15.9
19	231.19.00	19.1	22.0
25	231.25.00	25.4	28.4
33	230.33.00	33.3	48.0
33	231.33.00	33.3	42.0
41	231.41.00	41.3	50.8

Standard discs (larger sizes are webbed)



- Acetal – High torsional stiffness, good bearing properties, long backlash-free life.
- Nylon 11 – Resilient, isolates noise & vibration. Performance approximately 25% that of acetal disc.

Thro' bored discs



Thro' bored discs allow shafts to near-butt, standard thro' hole diameter = $\text{ØD} \times 0.5$. To order, add suffix 'T' to order code, eg., 236.25T
Other thro' hole diameters are manufactured to order. Specify the disc ref. and thro' hole diameter. This should equal the larger shaft diameter + 2 x max radial error.
Note that thro' bored discs reduce torsional stiffness.

Materials & Finishes

Hub sizes 06 to 13: Brass BS 2874 CZ121

Hub sizes 19 to 57: Al. Alloy 2014A T6 or AIECO 62 Sn T9

Fasteners: Alloy steel, black oiled

Blind & blank hubs: Irridite NCP finish

Thro' hubs:

Torque discs:

Clear anodised finish

Types 236 - Acetal (black)
Types 238 - Nylon 11 (natural)

Temperature Range

-20°C to +60°C



DIMENSIONS & ORDER CODES

Coupling Type and Size	Hub Ref		Dimensions								Fasteners			Disc Ref		
	Set Screw Style	Clamp Style	ØD	L	1 L1	2 L2	ØB1 Max	4 Moment of Inertia kgm ² x10 ⁻³	4 Mass kg x10 ⁻³	3 Size	3 Torque (Nm)	3 Wrench (mm)	Acetal (black) Std.	Nylon 11 (Natural)		
Blind Hubs	06	232.06	-	6.4	12.7	3.8	5.1	3.18	6	2.5	M3	0.94	1.5	236.06	238.06	
	09	232.09	-	9.5	12.7	3.8	5.1	5	18	4	M3	0.94	1.5	236.09	238.09	
	13	232.13	-	12.7	15.9	4.3	7.3	6.35	26	11	M3	0.94	1.5	236.13	238.13	
	19	232.19	-	19.1	22.0	6.3	9.4	8	67	12	M3	0.94	1.5	236.19	238.19	
		-	235.19	-	19.1	22.0	6.3	9.4	8	67	12	4-40	2.33	2.0	236.19	238.19
	25	232.25	-	25.4	28.4	8.6	11.2	12	252	31	M4	2.27	2.0	236.25	238.25	
		-	234.25	-	25.4	28.4	8.6	11.2	12	252	31	M3	2.43	2.5	236.25	238.25
		232.33	-	33.3	42.0	13.0	16.0	16	1074	72	M5	4.62	1.5	836.33	838.33	
		-	235.43	-	33.3	42.0	13.0	16.0	16	1074	72	M4	2.33	2.0	836.33	838.33
	33	243.33	-	33.3	48.0	13.0	22.0	16	1278	86	M4	2.27	3.0	236.33	238.33	
	-	245.33	-	33.3	48.0	13.0	22.0	16	1278	86	M4	5.66	2.5	236.33	238.33	
41	232.41	-	41.3	50.8	16.7	17.4	20	3327	148	M5	4.62	2.5	236.41	238.41		
	-	234.41	-	41.3	50.8	16.7	17.4	20	3327	148	M4	5.66	3.0	236.41	238.41	
Thro' Hubs	19	450H19	-	19.1	26.0	9.4	7.2	8	59	13	M5	4.62	2.5	236.19	238.19	
		-	452H33	-	19.1	26.0	9.4	7.2	8	13	4-40	2.33	2.0	236.19	238.19	
	25	450H25	-	25.4	32.4	11.6	9.2	12	252	31	M5	4.62	2.5	236.25	238.25	
		-	452H33	-	25.4	32.4	11.6	9.2	12	31	M3	2.43	2.5	236.25	238.25	
		450H33	-	33.3	42.0	15.0	12.0	16	1080	67	M6	7.61	3.0	836.33	838.33	
		-	452H33	-	33.3	42.0	15.0	12.0	16	67	M4	5.66	3.0	836.33	838.33	
	33	454H33	-	33.3	48.0	15.0	18.0	16	1133	74	M6	7.61	3.0	236.33	238.33	
		-	456H33	-	33.3	48.0	15.0	18.0	16	74	M4	5.66	3.0	236.33	238.33	
	41	450H41	-	41.3	50.8	17.8	15.3	20	3177	142	M6	7.61	3.0	236.41	238.41	
		-	452H41	-	41.3	50.8	17.8	15.3	20	142	M4	5.66	3.0	236.41	238.41	
50	450H50	-	50.0	59.6	20.6	18.4	25.4	7550	208	M8	18.36	4.0	236.50	-		
	-	452H50	-	50.0	59.6	20.6	18.4	25.4	208	M5	11.40	4.0	236.50	-		
57	450H57	-	57.1	78.0	28.4	21.2	30	12410	361	M8	18.36	4.0	236.57	-		
	-	452H57	-	57.1	78.0	28.4	21.2	30	361	M6	19.34	5.0	236.57	-		

PERFORMANCE (AT 20°C WITH STANDARD ACETAL DISC)

Coupling Size	5 Peak torque Nm	6 Max compensation @ 3000 r.p.m.			7 Torsional		Static break torque Nm
		Angular deg	Radial mm	Axial ± mm	Rate deg / Nm	Stiffness Nm / rad	
06	0.06	0.5	0.1	0.05	5.7	10	0.7
09	0.21		0.1	0.05	1.9	30	2
13	0.5		0.1	0.05	0.88	65	4
19	1.7		0.2	0.1	0.50	115	8
25	4		0.2	0.1	0.28	205	13
33	9		0.2	0.15	0.093	615	53
41	17		0.25	0.15	0.048	1200	57
50	30		0.25	0.2	0.042	1375	95
57	44		0.25	0.2	0.022	2610	150

NB. Size 33 available in both 'standard' and 'long' versions

IMPORTANT

Load capacity depends on application conditions: see page 6 for details

- 1 **Blind hubs:** Length of parallel bore ± 0.2 . Bores may terminate in 118° incl. angle.
Thro' hubs: Max permissible hub penetration.
- 2 **Blind hubs:** Nominal distance between unchamfered shafts bottomed out to L1.
Thro' hubs: Nominal distance between shafts with standard (unbored) disc.
- 3 Maximum recommended tightening torque (see also next page under 'Clamp hubs')
- 4 Values apply to complete couplings with max bores.
- 5 **Peak torque.** Select a size where Peak Torque exceeds the application torque x service factor.
- 6 Couplings can provide up to (ØD x 0.1) radial compensation in extreme cases. Observe given values for maximum backlash-free life.
Axial compensation is set on installation. See next page for details.
Electrical isolation between shafts > 3kV.
- 7 Values apply at 50% peak torque with no misalignment, measured shaft-to-shaft with largest standard bores.
- 8 Thro' hubs can be provided with keyways or 'D' bores. See page 56 for details.

For Standard Bores see page 26



Thro' hubs

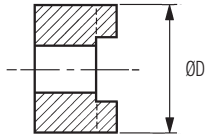

Thro' bores allow disc replacement without disturbing shaft alignment

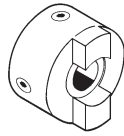

Set screw style



Clamp style

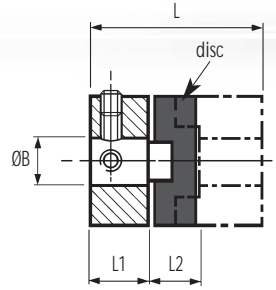

Ref. 850
Set screw style

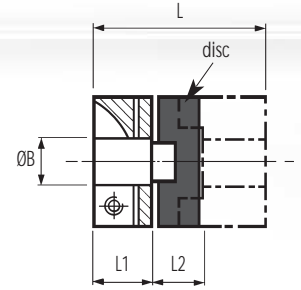

Ref. 852
Clamp style

DIMENSIONS & ORDER CODES

Size	Hub Ref		Dimensions							Fasteners			Disc Ref	
	Set Screw Style	Clamp Style	OD	L	L1	L2	ØB1 Max	Moment of Inertia kgm ² x10 ⁻³	Mass kg x10 ⁻³	Size	Torque (Nm)	A/F (mm)	Acetal (black) Std.	Nylon 11 (Nat)
25	850.25	-	25.4	32.4	11.6	9.2	12.0	587	76	M5	2.1	2.5	236.25	238.25
	-	852.25								M3	1.2	2.5		
33	850.33	-	33.3	42.0	15.0	12.0	16.0	2091	165	M6	3.8	3.0	836.33	838.33
	-	852.33								M4	2.9	3.0		
41	850.41	-	41.3	50.8	17.8	15.3	20.0	6822	305	M6	3.8	3.0	236.41	238.41
	-	852.41								M5	5.9	4.0		
50	850.50	-	50.0	59.6	20.6	20.6	25.4	17368	510	M8	9.0	4.0	236.50	N/A
	-	852.50								M6	9.8	5.0		

26

PERFORMANCE

Size	Peak Torque (Nm)	Max compensation @ 3000 rev/min			Torsional		Static break torque (Nm)
		Angular deg	Radial mm	Axial +/- mm	Rate deg/Nm	Stiff Nm/Rad	
25	4	0.5	0.2	0.1	0.28	205	13
33	9		0.2	0.15	0.093	615	53
41	17		0.25	0.15	0.048	1200	57
50	30		0.25	0.12	0.042	1375	95

STANDARD BORES⁸

Coupling Size	ØB +0.03/-0mm																							
	2	3	3.175	4	4.763	5	6	6.350	8	9.525	10	12	12.700	14	15	15.875	16	18	19	19.050	20	24	25	30
06	•	•	•																					
09		•	•	•	•	•																		
13		•	•	•	•	•	•	•																
19				•	•	•	•	•	•															
25							•	•	•	•	•													
33								•	•	•	•	•	•	•	•	•	•							
41									•	•	•	•	•	•	•	•	•	•	•	•	•	•	•	•
50										•	•	•	•	•	•	•	•	•	•	•	•	•	•	•
57											•	•	•	•	•	•	•	•	•	•	•	•	•	•
Bore ref.	11	14	16	18	19	20	22	24	28	31	32	35	36	38	40	41	42	45	46	47	48	51	52	56

Materials & Finishes

Hubs : Stainless Steel 303 S31 - Natural Finish
 Fasteners: Stainless Steel
 Discs: Torque disc details on page 24

Temperature Range

-20°C to +60°C

Maximum Rotational Speed

3000 rev/min

beam couplings

- Multi-Beam
- Single-Beam
- Step-Beam

- Torsionally rigid design
- Zero backlash
- No moving parts
- Single beam simple coupling compatible with industry standard types
- 3-Beam single stage for increased torsional stiffness
- 6-Beam two stage for torsional stiffness and increased radial compliance
- Step Beam for low inertia, electrical isolation, low cost

Beam couplings will readily accommodate any combination of axial motion, angular and parallel misalignment.

The 3 start helical-cut design provides higher torque capability and reduced wind-up compared with single beam versions.

Multi-Beam is available in three standard materials: stainless steel, aluminium and acetal, for shaft diameters from 1mm to 38mm.



Multi-Beam Stainless Steel Multi-Helix Flexible Beam Couplings



Set screw hubs

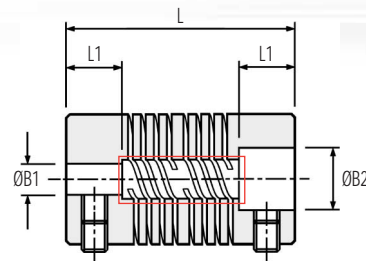
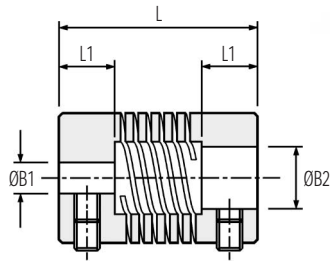

Ref. 702 : 6-Beam Non-Relieved
Ref. 722 : 6-Beam Relieved

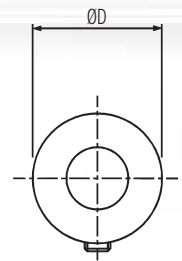

Typical

Clamp hubs

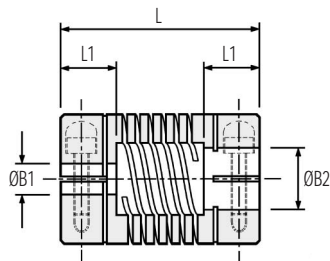

Ref. 721
3-Beam Relieved

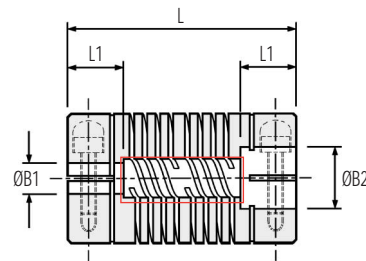

Ref. 703 : 6-Beam Non-Relieved
Ref. 723 : 6-Beam Relieved

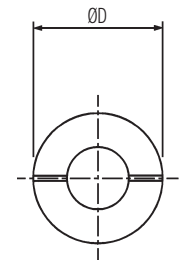

Typical

3-BEAM COUPLINGS: DIMENSIONS & ORDER CODES

Coupling Type & Size	Set Screw Style	Clamp Style	ØD	L	1	Bore Diameters			Set Screw	Cap Screw	2	2	3	
						Min B1	Min B2	Max B1 & B2						
Relieved	06	720.06	-	6.4	12.7	3.2	1.0	2.0	3.0	M2	-	3	0.07	0.45
	09	720.09	-	9.5	14.2	4.5	2.0	3.0	3.18	M2.5	M1.6	3	0.1	0.50
		-	721.09											
	13	720.13	-	12.7	19.1	6.0	3.0	4.0	5.0	M3	M2	5	0.127	1.0
		-	721.13											
	16	720.16	-	15.9	20.3	6.5	3.0	4.0	6.35	M4	M2.5	5	0.127	1.80
		-	721.16											
	19	720.19	-	19.1	22.9	6.5	4.0	4.76	8.0	M4	M2.5	5	0.127	2.70
		-	721.19											
	25	720.25	-	25.4	31.8	9.0	5.0	6.0	10.0	M5	M3	5	0.127	6.0
-		721.25	-											
32	720.32	-	31.8	44.5	12.0	6.0	8.0	14.0	M6	M4	5	0.127	10.0	
	-	721.32												-

All 3-beam couplings are in relieved form as standard. See above drawings.

Materials & Finishes

Couplings: Stainless Steel 303 S31
Fasteners: Stainless Steel

Temperature Range

-40°C to +140°C

BORE SIZES - SEE TABLE ON PAGE 32

Multi-Beam Stainless Steel Multi-Helix Flexible Beam Couplings



6-BEAM COUPLINGS: DIMENSIONS & ORDER CODES

Coupling Type & Size	Set Screw Style	Clamp Style	ØD	L	1	Bore Diameters			Set Screw	Cap Screw	2	Parallel Offset mm	3
						Min B1	Min B2	Max B1 & B2					
Non-Relieved	702.09	-	9.5	19.6	5.3	2.0	4.0	4.76	M2.5	M1.6	3	0.12	1.5
	-	703.09											
	702.13	-	12.7	25.4	6.5	3.0	5.0	6.35	M3	M2	5	0.17	3.0
	-	703.13											
	702.16	-	15.9	25.4	6.5	3.0	6.0	8.0	M4	M2.5	5	0.2	5.0
	-	703.16											
	702.19	-	19.1	28.0	6.5	4.76	6.35	10.0	M4	M2.5	7	0.25	8.0
	-	703.19											
	702.25	-	25.4	38.1	11.0	5.0	8.0	12.7	M5	M3	7	0.38	16.0
	-	703.25											
	702.32	-	31.8	57.2	16.0	8.0	10.0	19.0	M6	M4	7	0.5	25.0
	-	703.32						16.0					
	702.38	-	38.1	66.7	18.0	8.0	12.0	22.0	M6	M5	7	0.6	36.0
	-	703.38						19.0					
702.44	-	44.5	76.2	20.0	9.0	14.0	25.0	M6	M5	7	0.8	48.0	
-	703.44						22.0						
702.51	-	50.8	95.3	25.0	10.0	16.0	28.0	M8	M6	7	0.9	73.0	
-	703.51						26.0						
702.57	-	57.2	130.0	32.0	10.0	20.0	32.0	M8	M6	7	0.95	102.0	
-	703.57						30.0						
702.64	-	63.5	150.0	38.0	12.0	25.0	38.0	M8	M8	7	1.0	140.0	
-	703.64						36.0						

Materials & Finishes

Couplings: Stainless Steel 303 S31
Fasteners: Stainless Steel

Temperature Range

-40°C to +140°C

- 1 Length of supported bore.
- 2 Max. compensation values are mutually exclusive.
- 3 *Peak torque.* Select a size where Peak Torque exceeds the application torque x service factor. (see page 6)
- 4 *6-beam couplings only.* If either shaft extends beneath the beams, the area shown in blue must be *relieved* to provide clearance under the flexure.

Relieved	722.09	-	9.5	19.6	5.3	2.0	3.0	4.76	M2.5	M1.6	3	0.12	0.9
	-	723.09											
	722.13	-	12.7	25.4	6.5	3.0	4.0	6.35	M3	M2	5	0.17	1.9
	-	723.13											
	722.16	-	15.9	25.4	6.5	3.0	4.0	8.0	M4	M2.5	5	0.2	3.4
	-	723.16											
	722.19	-	19.1	28.0	6.5	4.76	5.0	10.0	M4	M2.5	7	0.25	4.8
	-	723.19											
	722.25	-	25.4	38.1	11.0	5.0	6.0	12.7	M5	M3	7	0.38	10.0
	-	723.25											
	722.32	-	31.8	57.2	16.0	8.0	9.53	19.0	M6	M4	7	0.5	13.0
	-	723.32						16.0					
	722.38	-	38.1	66.7	18.0	8.0	12.0	22.0	M6	M5	7	0.6	20.0
	-	723.38						19.0					
722.44	-	44.5	76.2	20.0	9.0	14.0	25.0	M6	M5	7	0.8	27.0	
-	723.44						22.0						
722.51	-	50.8	95.3	25.0	10.0	16.0	28.0	M8	M6	7	0.9	37.0	
-	723.51						26.0						
722.57	-	57.2	130.0	32.0	10.0	20.0	32.0	M8	M6	7	0.95	50.0	
-	723.57						30.0						
722.64	-	63.5	150.0	38.0	12.0	25.0	38.0	M8	M8	7	1.0	65.0	
-	723.64						36.0						

Sizes 38 - 64 manufactured to order only

BORE SIZES - SEE TABLE ON PAGE 33

If either shaft extends beneath the beams, the area shown outlined in red must be relieved to provide clearance under the flexure.

Multi-Beam Aluminium Multi-Helix Flexible Beam Couplings



Set screw hubs

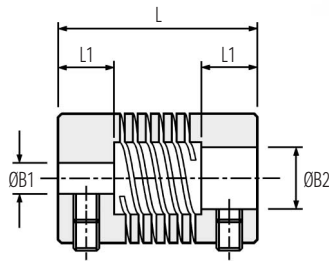

Ref. 724
3-Beam Relieved

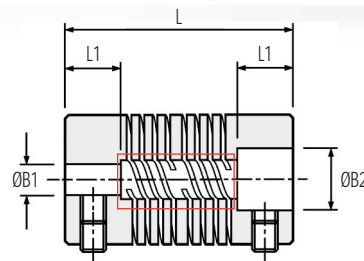

Ref. 706 : 6-Beam Non-Relieved
Ref. 726 : 6-Beam Relieved

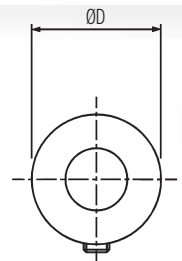

Typical

Clamp hubs

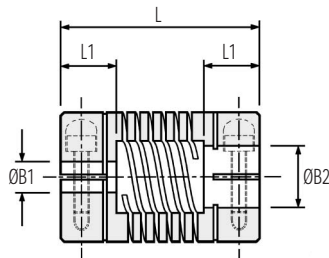

Ref. 725
3-Beam Relieved

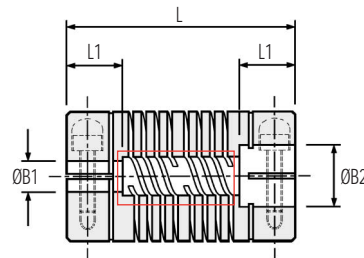

Ref. 707 : 6-Beam Non-Relieved
Ref. 727 : 6-Beam Relieved

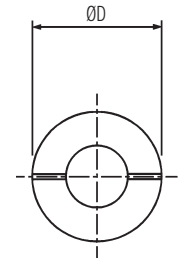

Typical

30

3-BEAM COUPLINGS: DIMENSIONS & ORDER CODES

Coupling Type & Size	Set Screw Style	Clamp Style	ØD	L	L1	Bore Diameters			Set Screw	Cap Screw	2 Angular Offset Deg.	2 Parallel Offset mm	3 Peak Torque Nm	
						Min B1	Min B2	Max B1 & B2						
Relieved	06	724.06	-	6.4	12.7	3.2	1.0	2.0	3.0	M2	-	3	0.07	0.40
	09	724.09	-	9.5	14.2	4.5	2.0	3.0	3.18	M2.5	M1.6	3	0.1	0.40
		-	725.09											
	13	724.13	-	12.7	19.1	6.0	3.0	4.0	5.0	M3	M2	5	0.127	0.90
		-	725.13											
	16	724.16	-	15.9	20.3	6.5	3.0	4.0	6.35	M4	M2.5	5	0.127	1.50
		-	725.16											
	19	724.19	-	19.1	22.9	6.5	4.0	4.76	8.0	M4	M2.5	5	0.127	2.50
		-	725.19											
	25	724.25	-	25.4	31.8	9.0	5.0	6.0	10.0	M5	M3	5	0.127	4.0
-		725.25	-											
32	724.32	-	31.8	44.5	12.0	6.0	8.0	14.0	M6	M4	5	0.127	6.0	
	-	725.32												-

All 3-beam couplings are in relieved form as standard. See above drawings.

Materials & Finishes

Couplings: Aluminium L168 or better

Fasteners: Alloy steel. black oiled

Temperature Range

-40°C to +120°C

BORE SIZES - SEE TABLE ON PAGE 32

Multi-Beam Aluminium Multi-Helix Flexible Beam Couplings



6-BEAM COUPLINGS: DIMENSIONS & ORDER CODES

Coupling Type & Size	Set Screw Style	Clamp Style	ØD	L	1	Bore Diameters			Set Screw	Cap Screw	2	Angular Offset Deg.	Parallel Offset mm	3
						Min B1	Min B2	Max B1 & B2						
Non-Relieved	09	706.09 -	707.09	9.5	19.6	5.3	2.0	4.0	4.76	M2.5	M1.6	3	0.12	1.0
	13	706.13 -	707.13	12.7	22.9	6.5	3.0	5.0	6.35	M3	M2	5	0.17	2.0
	16	706.16 -	707.16	15.9	25.4	6.5	3.0	6.0	8.0	M4	M2.5	5	0.2	3.4
	19	706.19 -	707.19	19.1	26.5	6.5	4.76	6.35	10.0	M4	M2.5	7	0.25	5.3
	25	706.25 -	707.25	25.4	38.1	11.0	5.0	8.0	12.7	M5	M3	7	0.38	10.0
	32	706.32 -	707.32	31.8	57.2	16.0	8.0	10.0	19.0 16.0	M6	M4	7	0.5	15.0
	38	706.38 -	707.38	38.1	66.7	18.0	8.0	12.0	22.0 19.0	M6	M5	7	0.6	22.0
	44	706.44 -	707.44	44.5	76.2	20.0	9.0	14.0	25.0 22.0	M6	M5	7	0.8	30.0
	51	706.51 -	707.51	50.8	95.3	25.0	10.0	16.0	28.0 26.0	M8	M6	7	0.9	40.0
	57	706.57 -	707.57	57.2	130.0	32.0	10.0	20.0	32.0 30.0	M8	M6	7	0.95	55.0
64	706.64 -	707.64	63.5	150.0	38.0	12.0	25.0	38.0 36.0	M8	M8	7	1.0	75.0	

Relieved	09	726.09 -	727.09	9.5	19.6	5.3	2.0	3.0	4.76	M2.5	M1.6	3	0.12	0.6
	13	726.13 -	727.13	12.7	22.9	6.5	3.0	4.0	6.35	M3	M2	5	0.17	1.3
	16	726.16 -	727.16	15.9	25.4	6.5	3.0	4.0	8.0	M4	M2.5	5	0.2	2.0
	19	726.19 -	727.19	19.1	26.5	6.5	4.76	5.0	10.0	M4	M2.5	7	0.25	3.0
	25	726.25 -	727.25	25.4	38.1	11.0	5.0	6.0	12.7	M5	M3	7	0.38	5.0
	32	726.32 -	727.32	31.8	57.2	16.0	8.0	9.53	19.0 16.0	M6	M4	7	0.5	7.0
	38	726.38 -	727.38	38.1	66.7	18.0	8.0	12.0	22.0 19.0	M6	M5	7	0.6	11.0
	44	726.44 -	727.44	44.5	76.2	20.0	9.0	14.0	25.0 22.0	M6	M5	7	0.8	15.0
	51	726.51 -	727.51	50.8	95.3	25.0	10.0	16.0	28.0 26.0	M8	M6	7	0.9	20.0
	57	726.57 -	727.57	57.2	130.0	32.0	10.0	20.0	32.0 30.0	M8	M6	7	0.95	28.0
64	726.64 -	727.64	63.5	150.0	38.0	12.0	25.0	38.0 36.0	M8	M8	7	1.0	38.0	

Sizes 38 - 64 manufactured to order only

BORE SIZES - SEE TABLE ON PAGE 33

Materials & Finishes

Couplings: Aluminium L168 or better
Fasteners: Alloy steel, black oiled

Temperature Range

-40°C to +120°C

- 1 Length of supported bore.
- 2 Max. compensation values are mutually exclusive.
- 3 Peak torque. Select a size where Peak Torque exceeds the application torque x service factor. (see page 6)
- 4 6-beam couplings only. If either shaft extends beneath the beams, the area shown in blue must be relieved to provide clearance under the flexure.

If either shaft extends beneath the beams, the area shown outlined in red must be relieved to provide clearance under the flexure.

Multi-Beam Acetal Multi-Helix Flexible Beam Couplings



Set screw hubs

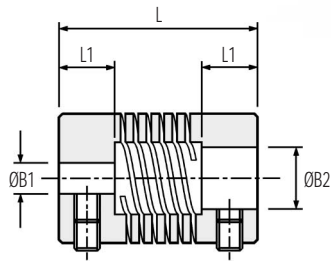

Ref. 728
3-Beam Relieved

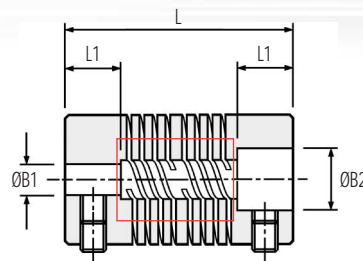

Ref. 710 : 6-Beam Non-Relieved
Ref. 730 : 6-Beam Relieved

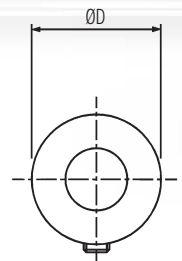

Typical

Clamp hubs

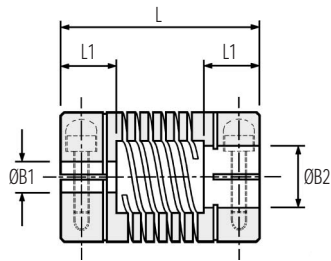

Ref. 729
3-Beam Relieved

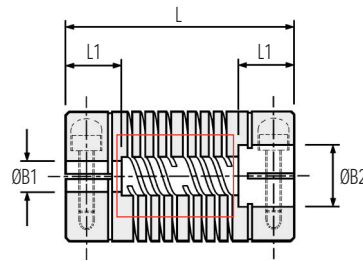

Ref. 711 : 6-Beam Non-Relieved
Ref. 731 : 6-Beam Relieved

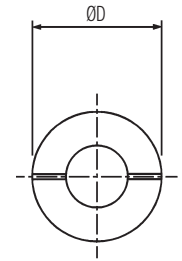

Typical

32

3-BEAM COUPLINGS: DIMENSIONS & ORDER CODES

Coupling Type & Size	Set Screw Style	Clamp Style	ØD	L	L1	Bore Diameters			Set Screw	Cap Screw	Angular Offset Deg.	Parallel Offset mm	Peak Torque Nm
						Min B1	Min B2	Max B1 & B2					
Relieved	13	728.13 - 729.13	12.7	19.1	6.0	3.0	4.0	5.0	M3	M2	5	0.127	0.24
	16	728.16 - 729.16	15.9	20.3	6.5	3.0	4.0	6.0	M4	M2.5	5	0.127	0.35
	19	728.19 - 729.19	19.1	22.9	6.5	4.0	4.76	8.0	M4	M2.5	5	0.127	0.64
	25	728.25 - 729.25	25.4	31.8	9.0	5.0	6.0	10.0	M5	M3	5	0.127	1.40
	32	728.32 - 729.32	31.8	44.5	12.0	6.0	8.0	12.0	M6	M4	5	0.127	2.50

Materials & Finishes

Couplings: Acetal (natural)

Fasteners: Stainless steel

Temperature Range

-20°C to +60°C

All 3-beam couplings are in relieved form as standard. See above drawings.

BORE SIZES 3-BEAM COUPLINGS

Coupling Size	ØB1, ØB2 +0.03/-0mm															
	1	2	3	3.175	4	4.763	5	6	6.350	8	9.525	10	12	12.700	14	
06	○	●	●													
09		○	●	●												
13			○	○	●	●	●									
16			○	○	●	●	●	●	●							
19					○	●	●	●	●	●						
25							○	●	●	●	●	●				
32								○	○	●	●	●	●	●	●	●
Bore ref.	08	11	14	16	18	19	20	22	24	28	31	32	35	36	38	

○ B1 only ● B1 & B2

● Aluminium and Stainless Steel Only

Multi-Beam Acetal Multi-Helix Flexible Beam Couplings



6-BEAM COUPLINGS: DIMENSIONS & ORDER CODES

Coupling Type & Size	Set Screw Style	Clamp Style	ØD	L	1	Bore Diameters			Set Screw	Cap Screw	2	2	3	
						Min B1	Min B2	Max B1 & B2						
Non-Relieved	13	710.13 -	-	12.7	22.9	6.5	3.0	5.0	6.0	M3	M2	5	0.17	0.51
	16	710.16 -	-	15.9	25.4	6.5	3.0	6.0	8.0	M4	M2.5	5	0.2	0.91
	19	710.19 -	-	19.1	26.5	6.5	4.0	6.35	9.53	M4	M2.5	7	0.25	1.3
	25	710.25 -	-	25.4	38.1	11.0	5.0	8.0	12.0	M5	M3	7	0.38	2.5
	32	710.32 -	-	31.8	57.2	16.0	8.0	10.0	16.0	M6	M4	7	0.5	4.0

Materials & Finishes

Couplings: Acetal (natural)
Fasteners: Stainless steel

Temperature Range

-20°C to +60°C

- Length of supported bore.
- Max. compensation values are mutually exclusive.
- Peak torque. Select a size where Peak Torque exceeds the application torque x service factor (see page 6).
- 6-beam couplings only. If either shaft extends beneath the beams, the area shown in blue must be relieved to provide clearance under the flexure.

Relieved	13	730.13 -	-	12.7	22.9	6.5	3.0	4.0	5.0	M3	M2	5	0.17	0.32
	16	730.16 -	-	15.9	25.4	6.5	3.0	4.0	6.35	M4	M2.5	5	0.2	0.61
	19	730.19 -	-	19.1	26.5	6.5	4.0	5.0	8.0	M4	M2.5	7	0.25	0.87
	25	730.25 -	-	25.4	38.1	11.0	5.0	6.0	10.0	M5	M3	7	0.38	1.67
	32	730.32 -	-	31.8	57.2	16.0	8.0	9.53	12.7	M6	M4	7	0.5	2.4

If either shaft extends beneath the beams, the area shown outlined in red must be relieved to provide clearance under the flexure.

BORE SIZES 6-BEAM COUPLINGS

NON-RELIEVED

33

Size	ØB1, ØB2 +0.03/-0mm																											
	2	3	3.175	4	4.763	5	6	6.35	8	9.525	10	12	12.7	14	15.88	16	18	19	19.05	20	24	25	25.4	28	30	31.75	32	
9	○	○	○	●	●																							
13		○	○	○	○	●	●	●																				
16		○	○	○	○	○	●	●	●																			
19					○	○	○	●	●	●	●	●	●															
25						○	○	○	○	○	○	○	○	○	○	○	○	○	○	○	○	○	○	○	○	○	○	○
32									○	○	○	○	○	○	○	○	○	○	○	○	○	○	○	○	○	○	○	○
38									○	○	○	○	○	○	○	○	○	○	○	○	○	○	○	○	○	○	○	○
44										○	○	○	○	○	○	○	○	○	○	○	○	○	○	○	○	○	○	○
51											○	○	○	○	○	○	○	○	○	○	○	○	○	○	○	○	○	○
57												○	○	○	○	○	○	○	○	○	○	○	○	○	○	○	○	○
64													○	○	○	○	○	○	○	○	○	○	○	○	○	○	○	○
Bore ref.	11	14	16	18	19	20	22	24	28	31	32	35	36	38	41	42	45	46	47	48	51	52	53	54	56	57	58	

BORE SIZES 6-BEAM COUPLINGS

RELIEVED

Size	ØB1, ØB2 +0.03/-0mm																											
	2	3	3.175	4	4.763	5	6	6.35	8	9.525	10	12	12.7	14	15.88	16	18	19	19.05	20	24	25	25.4	28	30	31.75	32	
9	○	●	●	●	●																							
13		○	○	○	○	○	○	○	○	○	○	○	○	○	○	○	○	○	○	○	○	○	○	○	○	○	○	○
16		○	○	○	○	○	○	○	○	○	○	○	○	○	○	○	○	○	○	○	○	○	○	○	○	○	○	○
19					○	○	○	○	○	○	○	○	○	○	○	○	○	○	○	○	○	○	○	○	○	○	○	○
25						○	○	○	○	○	○	○	○	○	○	○	○	○	○	○	○	○	○	○	○	○	○	○
32									○	○	○	○	○	○	○	○	○	○	○	○	○	○	○	○	○	○	○	○
38										○	○	○	○	○	○	○	○	○	○	○	○	○	○	○	○	○	○	○
44											○	○	○	○	○	○	○	○	○	○	○	○	○	○	○	○	○	○
51												○	○	○	○	○	○	○	○	○	○	○	○	○	○	○	○	○
57													○	○	○	○	○	○	○	○	○	○	○	○	○	○	○	○
64														○	○	○	○	○	○	○	○	○	○	○	○	○	○	○
Bore ref.	11	14	16	18	19	20	22	24	28	31	32	35	36	38	41	42	45	46	47	48	51	52	53	54	56	57	58	

○ B1 only ● B1 & B2 ◻ Aluminium and Stainless Steel Only

S-Beam Single Helix Beam Couplings - Stainless Steel



Set Screw Hubs

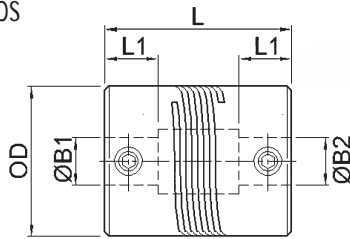

Clamp Hubs

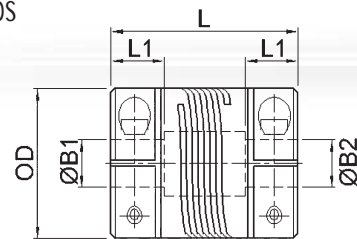

DIMENSIONS & ORDER CODES

Size	Set Screw Style	Clamp Style	Dimensions							Fasteners			
			Order Code	O.D.	O/A Length L	Bore Depth L1	Min B1	Min B2	Max B1 & B2	Mass kg x 10 ⁻³	Set Screw	Cap Screw	Torque (Nm)
16	820.16	-	15.9	20	6.0	3	4	6.35	25.6	M4	-	1.05	2.0
	-	821.16		22	6.5					-	M2.5	0.68	2.0
19	820.19	-	19.1	20	6.0	4	4.76	8	35.8	M4	-	1.05	2.0
	-	821.19		28	8.0					-	M2.5	0.68	2.0
25	820.25	-	25.4	24	7.5	5	6	10	78	M5	-	2.10	2.5
	-	821.25		30	10.0					-	M3	1.20	2.5
32	820.32	-	31.8	30	10.0	6	8	16	152	M6	-	3.75	3.0
	-	821.32		38	12.0					-	M4	2.85	3.0
38	820.38	-	38.1	50	16.0	8	12	19	365	M6	-	3.75	3.0
	-	821.38		50	16.0					-	M5	5.85	4.0
50	820.50	-	50.8	54	18.0	10	16	26	680	M8	-	9.00	4.0
	-	821.50		54	18.0					-	M6	9.75	5.0

34

PERFORMANCE

Size	Peak Torque (Nm)	Max misalignment compensation			Nominal stiffness at std. bore size	
		Angular deg	Radial mm	Axial mm	Bore	Torsional Nm/rad
16	1.2	5	0.25	0.25	5	16
19	2.3	5	0.25	0.25	6	33
25	4.3	5	0.25	0.25	10	45
32	7.8	5	0.25	0.25	12	84
38	20	5	0.25	0.25	16	195
50	30	5	0.25	0.25	20	320

Materials & Finishes

Couplings: Stainless Steel 303 S31
Fasteners: Stainless Steel

Temperature Range

-40°C to +140°C

AVAILABLE BORES

Size	+0.03/-0mm																					
	3	3.175	4	4.763	5	6	6.350	7.938	8	9	9.525	10	12	12.700	14	15	15.875	16	19.050	20	24	25
16	○	○	●	●	●	●	●															
19			○	●	●	●	●		●													
25					○	●	●	●	●	●	●											
32						○	○	●	●	●	●	●	●	●	●	●	●	●				
38											●	●	●	●	●	●	●	●				
50														●	●	●	●	●	●	●	●	●
Bore Ref	14	16	18	19	20	22	24	27	28	30	31	32	35	36	38	40	41	42	47	48	52	53

○ B1 only ● B1 & B2



+44 (0) 1992 501900

S-Beam Single Helix Beam Couplings - Aluminium



Set Screw Hubs

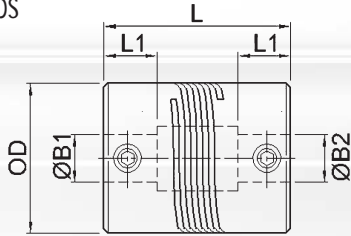

Clamp Hubs

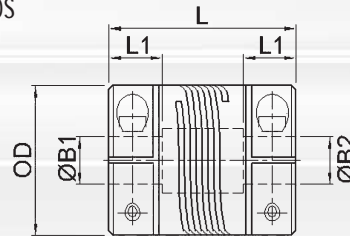

DIMENSIONS & ORDER CODES

Size	Set Screw Style	Clamp Style	Dimensions							Fasteners			
			Order Code	O.D.	O/A Length L	Bore Depth L1	Min B1	Min B2	Max B1 & B2	Mass kg x 10 ⁻³	Set Screw	Cap Screw	Torque (Nm)
16	826.16	-	15.9	20	6.0	3	4	6.35	8.8	M4	-	2.27	2.0
	-	827.16		22	6.5				9.8	-	M2.5	1.32	2.0
19	826.19	-	19.1	20	6.0	4	4.76	8	13.1	M4	-	2.27	2.0
	-	827.19		28	8.0				17.3	-	M2.5	1.32	2.0
25	826.25	-	25.4	24	7.5	5	6	10	28	M5	-	4.62	2.5
	-	827.25		30	10.0				33	-	M3	2.43	2.5
32	826.32	-	31.8	30	10.0	6	8	16	55	M6	-	7.61	3.0
	-	827.32		38	12.0				67	-	M4	5.66	3.0
38	826.38	-	38.1	50	16.0	8	12	19	127	M6	-	7.61	3.0
	-	827.38		50	16.0				130	-	M5	11.40	4.0
50	826.50	-	50.8	54	18.0	10	16	26	241	M8	-	18.36	4.0
	-	827.50		54	18.0				237	-	M6	19.34	5.0

35

PERFORMANCE

Size	Peak Torque (Nm)	Max misalignment compensation			Nominal stiffness at std. bore size	
		Angular deg	Radial mm	Axial mm	Bore	Torsional Nm/rad
16	0.6	5	0.25	0.25	5	6
19	1.1	5	0.25	0.25	6	12
25	2.2	5	0.25	0.25	10	17
32	4.1	5	0.25	0.25	12	32
38	10	5	0.25	0.25	16	70
50	15	5	0.25	0.25	20	119

Materials & Finishes

Couplings: Aluminium L 168 or better

Fasteners: Alloy steel, black oiled

Temperature Range

-40°C to +120°C

AVAILABLE BORES

Size	+0.03/-0mm																					
	3	3.175	4	4.763	5	6	6.350	7.938	8	9	9.525	10	12	12.700	14	15	15.875	16	19.050	20	24	25
16	○	○	●	●	●	●	●															
19			○	●	●	●	●		●													
25					○	●	●	●	●	●	●											
32						○	○	●	●	●	●	●	●	●	●	●	●					
38											●	●	●	●	●	●	●	●				
50														●	●	●	●	●	●	●	●	●
Bore Ref	14	16	18	19	20	22	24	27	28	30	31	32	35	36	38	40	41	42	47	48	52	53

○ B1 only ● B1 & B2

Step-Beam Step Beam Couplings - Nylon



Set Screw Hubs

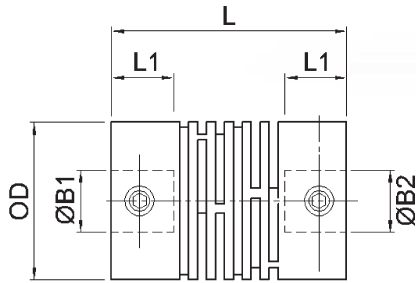

Clamp Hubs

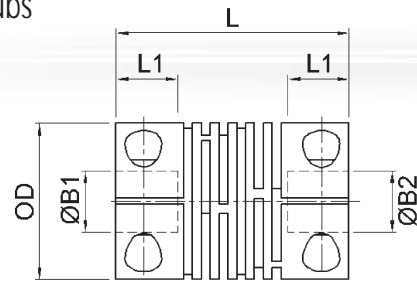

DIMENSIONS & ORDER CODES

Size	Set Screw Style	Clamp Style	Dimensions						Fasteners			
	Order Code		O.D.	O/A Length L	Max Shaft Depth L1	Min Bore	Max Bore	Mass kg x 10-3	Set Screw	Cap Screw	Torque (Ncm)	A/F (mm)
13	636.13	-	13	18	5.0	3	6.35	3.0	M2	-	0.08	0.9
	-	637.16							-	M2	0.23	1.5
19	636.19	-	19	28	8.0	3	9.53	7.5	M3	-	0.32	1.5
	-	637.19							-	M2.5	0.51	2.0
25	636.25	-	25	36	10.0	6	12.7	17.4	M4	-	1.05	2.0
	-	637.25							-	M3	0.90	2.5

36

PERFORMANCE

Size	Peak Torque (Nm)	Torsional Stiffness (Nm/rad)	Max misalignment / displacement		
			Angular deg	Radial mm	Axial mm
13	0.25	5.5	3	0.15	0.2
19	0.8	12.0	4	0.15	0.2
25	2.5	18.0	5	0.3	0.3

AVAILABLE BORES

Size	+0.05/-0mm												
	3	3.175	4	4.763	5	6	6.350	7.938	8	9.525	10	12	12.700
13	●	●	●	●	●	●	●						
19			●	●	●	●	●	●	●	●			
25						●		●	●	●	●	●	●
Bore Ref	14	16	18	19	20	22	24	27	28	31	32	35	36

Materials & Finishes

Couplings: Nylon type engineering polymer
Fasteners: Stainless Steel

Temperature Range

-20°C to +150°C

drive couplings

- Flexible Double Loop
- Flexible Jaw (Spider)
- Magnetic

General purpose couplings for light power drives.

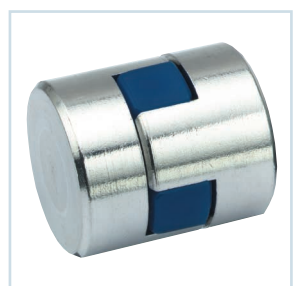
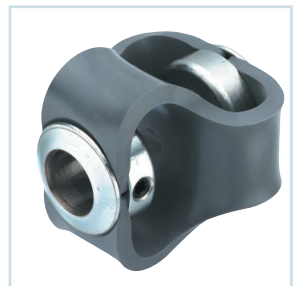
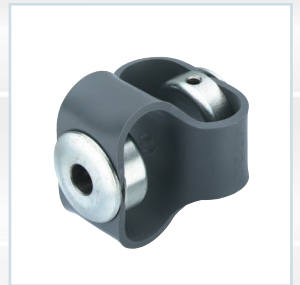
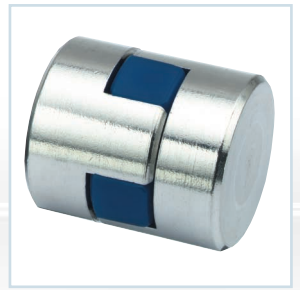

Flex - G Flexible Jaw Coupling

Huco Flexible Jaw Couplings utilise the flexibility and resilience of a polyurethane element between aluminium hubs. This combination allows high torque to be transmitted with little or no back-lash, even where there is significant angular and/or parallel misalignment.

- Zero / Low backlash
- Rated up to 17Nm Torque
- Choice of 3 polyurethane elements

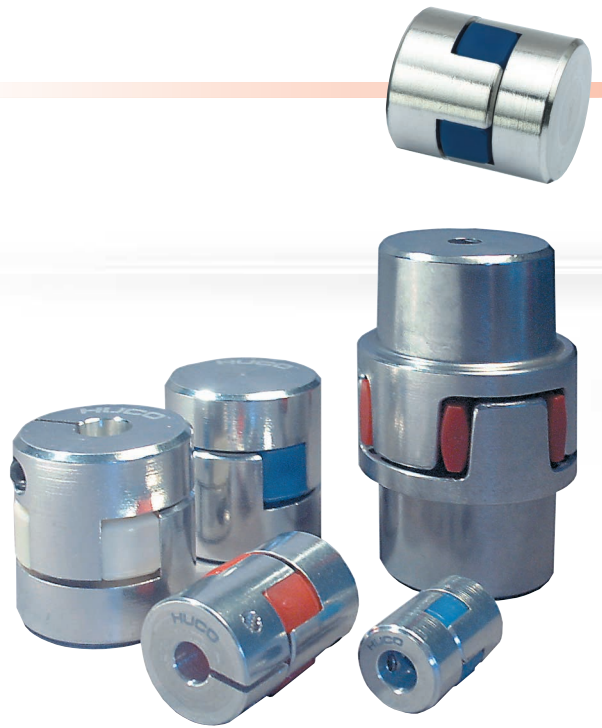

Set Screw Hubs

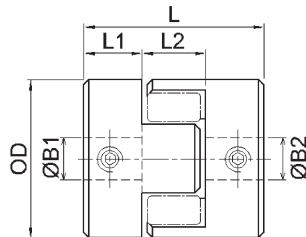

Thro' Clamp Hubs

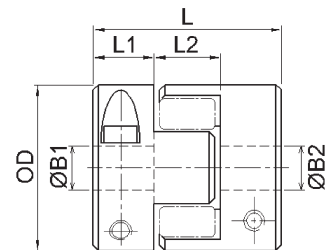
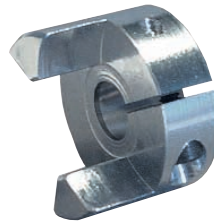

Pilot Hubs

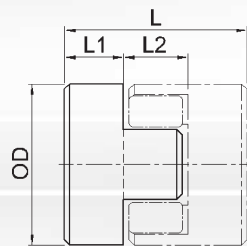
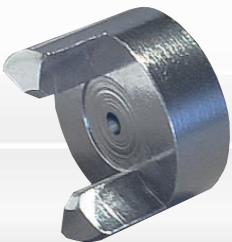

User-adaptable for special needs e.g. fitting within tubes. Blank hubs are supplied centred with no provision for fastening. External dimensions identical with blind hubs. Except size 40 which has 6.35 pilot hole.

Elements

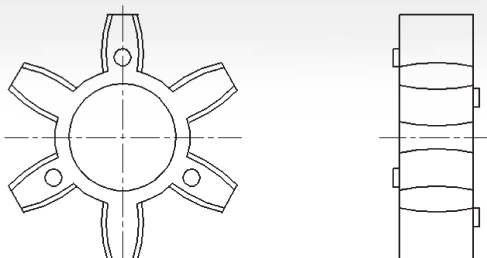

Polyurethane elements are available with three hardness levels; hard, standard and soft which exhibit different operating characteristics. Other features of polyurethane are:

- Resistance to oils, grease and many solvents
- Good atmospheric and chemical resistance
- Excellent shock and vibration damping

Flex - G Flexible Jaw Coupling

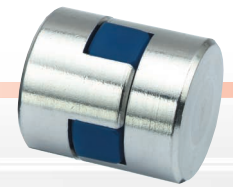

DIMENSIONS & ORDER CODES

Coupling Size	Set Screw Style	Clamping Style	Pilot Hub	ØD	L	L1	L2	ØB1 max	Fasteners			Moment of inertia kgm ² x 10 ⁻³	Mass kg x 10 ⁻³	Soft (Blue)	Med (White)	Hard (Red)
									Screw	Torque Nm	Wrench mm					
14	802.14	-	-	14.0	22.0	7.0	8.0	6.35	M3	0.94	1.5	18.4	7.0	804.14	805.14	806.14
	-	803.14	-						M2.5	1.32	2.5					
	-	-	800.14						-	-	-					
20	802.20	-	-	20.0	30.0	10.0	10.0	9.0	M3	0.94	1.5	106.0	17.0	804.20	805.20	806.20
	-	803.20	-						M3	2.43	2.5					
	-	-	800.20						-	-	-					
30	802.30	-	-	30.0	35.0	11.0	13.0	14.0	M4	2.27	2.0	606.0	51.0	804.30	805.30	806.30
	-	803.30	-						M3	2.43	2.5					
	-	-	800.30						-	-	-					
40	802.40	-	-	40.0	66.0	25.0	16.0	16.0	M5	4.62	2.5	4230.0	108.0	804.40	805.40	806.40
	-	803.40	-						M4	5.66	3.0					
	-	-	800.40						-	-	-					

PERFORMANCE (AT 20°C)

Coupling Size	Spider Rigidity Duro ⁷	Misalignment		Speed R.P.M. max	Torsional ⁵		Backlash Free Torque Nm	Torque Nominal ⁴ Nm	Torque Max Nm
		Angular deg	Radial mm		Rate deg/Nm	Stiffness Nm/rad			
20	80 Blue 92 White 98 Red	2	0.15	28000	3.37 2.05 1.22	17 28 47	0.45	1.80 2.93 4.85	3.60 6.00 9.70
30	80 Blue 92 White 98 Red	2	0.20	19000	1.24 0.40 0.25	71 143 228	1.00	3.95 7.33 12.40	7.90 14.60 24.80
40	80 Blue 92 White 98 Red	2	0.38	14000	0.34 0.17 0.10	170 344 573	2.40	4.85 9.80 16.70	9.70 19.60 33.40

- 1 Maximum permissible hub penetration
- 2 Maximum recommended tightening torque
- 3 Values apply to complete couplings with max. bores
- 4 Nominal Torque. Select a size where Nominal Torque exceeds application torque x service factor (see page 6)
- 5 Values apply at 50% nominal torque, measured shaft to shaft with largest standard bores
- 6 Hubs can be provided with keyways or 'D' bores
- 7 Spider Durometer is shore 'A' hardness

STANDARD BORES

Coupling Size	+0.03/-0mm															
	3	3.175	4	4.763	5	6	6.350	8	9.525	10	12	12.700	14	15	15.875	16
14	●	●	●	●	●	●	●									
20			●	●	●	●	●									
30						●	●	●	●	●	●	●	●			
40								●	●	●	●	●	●	●	●	●
Bore ref.	14	16	18	19	20	22	24	28	31	32	35	36	38	40	41	42

Materials & Finishes

Hub sizes 14 - 30: Al. Alloy 2024
 Hub size 40: Cast Aluminium LM9
 Membranes: Polyurethane
 Fastener: Alloy steel, black oiled

Temperature Range

-40°C to +80°C
 For short durations up to 100°C

Flex - P Double Loop Flexible Coupling

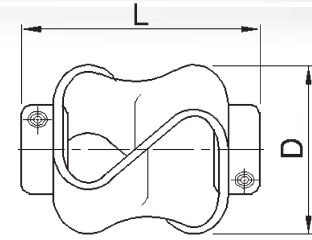
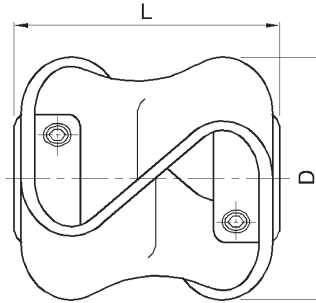
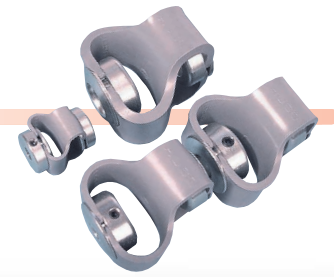

DIMENSIONS & ORDER CODES

Size	steel zinc plated hubs	stainless steel hubs	Dimensions					Fasteners		
	Order Code		Max Diameter	Length L +/- 1.0	Bore length	Max Bores	Mass kg x 10 ⁻³	Size	Torque (Nm)	A/F (mm)
10	047.10	-	27	27	7.9	9.53	25	M3	0.94	1.5
	-	049.10							0.32	
20	047.20	-	48	48	12.7	12.7	92	M4	2.27	2.0
	-	049.20							2.0	
30	047.30	-	54	55	16.0	16.0	124	M5	4.62	2.5
	-	049.30							2.1	
40	047.40	-	56	56	16.0	16.0	136	M6	7.61	3.0
	-	049.40							3.75	
40*	-	050.40	56	56	16.0	16.0	136	M6	7.61	3.0

40

PERFORMANCE

Size	Max Torque 1 (Nm)	Max Torque 2 (Nm)	max misalignment/displacement		
			Angular deg	Radial mm	Axial +/- mm
10	0.5	0.8	10	2.6	4.5
20	1.8	3	15	3.2	7.5
30	5	8	15	3.2	8.5
40	10	18	15	3.2	11
40*	2.5	4.5	15	3.2	11

Torque 1 = torque at maximum displacement
 Torque 2 = torque at 1 deg. angular, 2mm axial and 0.5mm radial displacement

Materials & Finishes

Hubs: Steel 230M07 pb Zn plated + clear passivate or
 Stainless Steel 303 S31 natural finish
Flexing Element: Hytrel
Fastener: Steel Hub: Alloy steel, black oiled
 Stainless Steel Hub: stainless steel

Temperature Range

-40°C to +100°C

Maximum Rotational Speed

3000 rev/min

STANDARD BORES*

Size	+0.05/-0mm																
	3	3.175	4	4.763	5	6	6.350	7.938	8	9.525	10	12	12.700	14	15	15.875	16
10	●	●	●	●	●	●	●	●	●	●	●						
20						●	●	●	●	●	●	●	●				
30										●	●	●	●	●	●	●	●
40										●	●	●	●	●	●	●	●
Bore Ref	14	16	18	19	20	22	24	27	28	31	32	35	36	38	40	41	42

* Couplings with dissimilar bores are non-standard

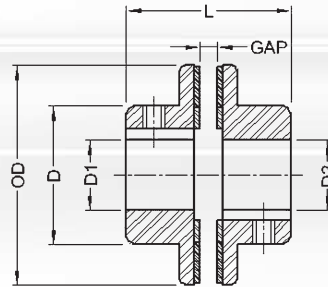

- High Energy Rare Earth Magnets
- Smooth Running
- Overload protection to 110%
- Torsionally soft
- Electrical / Mechanical / Chemical isolation
- Stainless Steel Hubs Type 416

DIMENSIONS & ORDER CODES

Size	Stainless Steel Hub Order Code	Dimensions							Fasteners		
		O.D.	O/A Length L	Recommended Air Gap	Hub Length L1	Hub Dia D	Max Bore	Mass* kg x 10 ⁻³	Size Metric Inch**	Torque (Nm)	A/F (mm) inch
40	MTD.40	44	35	4.75	15.0	20.6	8	0.11	M4 #8-32	1.05 0.95	2.0 5/64
50	MTD.50	50	35	4.75	15.0	28.5	12.7	0.17	M5 #10-32	2.1 2	2.5 3/32
60	MTD.60	60	43	4.75	19.8	38.1	19.0	0.30	M5 #10-32	2.1 2	2.5 3/32
70	MTD.70	73	56	4.75	25.4	51.0	25.4	0.58	M5 #10-32	2.1 2	2.5 3/32

PERFORMANCE

Size	Max Running Torque (Nm)	Slip Torque (Nm)	max misalignment/displacement	
			Angular deg	Radial mm
40	0.34	0.45	3	6.35
50	0.68	0.79	3	6.35
60	1.02	1.13	3	6.35
70	1.81	2.15	3	6.35

*half coupling ** metric bores supplied with metric screws

TORQUE VS. AIR GAP

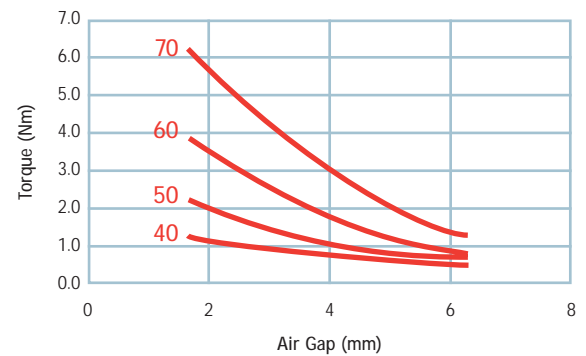

STANDARD BORES

Size	+0.05/-0mm													
	3.175	5	6	6.35	7.938	10	11	12.7	14	15.875	19	19.05	22.225	25.4
40	●	●	●	●	●									
50			●	●	●	●	●	●						
60							●	●	●	●	●	●		
70								●	●	●	●	●	●	●
Bore Ref	14	20	122	24	27	32	33	36	38	42	46	47	50	53

Also available unbored - use bore code 0000

You can now...

Download or order catalogues

•
Download our *Designer's Guide to Precision Shaft Couplings*

•
Find a distributor in your area

•
Read the latest product news

•
Browse detailed information on all Huco products

•
Search for products by order code or keyword

42



@

www.huco.com

plastic universal joints and teleshafts

- Backlash-free up to 10^8 turns
- Low mass
- Low inertia
- Corrosion resistant
- Electrically isolating
- No maintenance

Huco-Pol is a range of light duty, backlash-free universal joints and teleshafts manufactured of acetal and non-ferrous metals.

They are suitable for intermittent applications where low mass, corrosion resistance and electrical isolation are desirable.

Huco-Pol joints and teleshafts have only a fraction of the torque capability of steel joints and are not intended to substitute for these in the normal way.

Huco-Pols are used in business machines, food processing plant, laboratory equipment and electro-medical apparatus among others.

Alternative polymers are available for high temperature operation.



Huco - Pol Plastic Universal Joints

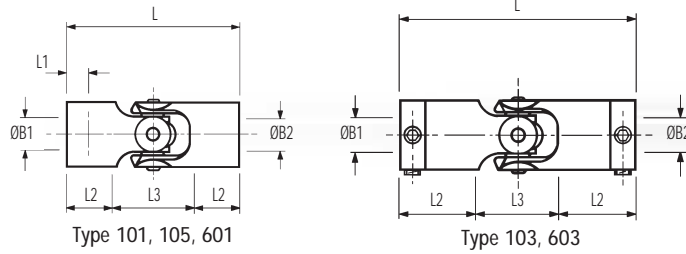
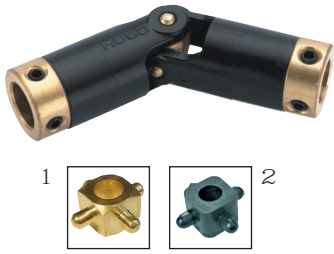

SINGLE JOINTS - DIMENSIONS & ORDER CODES

Size	1	2	Dimensions							Fasteners			
	Brass Cross-piece	Plastic Cross-piece	OD	L	L1	L2	L3	B1, B2 Max	Moment of inertia kgm ² x 10 ⁻⁸	Mass kg x 10 ⁻³	Size	Torque (Nm)	A/F (mm)
	Hub Ref												
06	101.06	-	7.1	19.1	3.3	5.3	8.6	4.76	0.3	0.7	-	-	-
	-	601.06							0.2	0.4			
	103.06	-		27.2	-	9.3		3.18	1.1	3.1	M3	0.94	1.5
	-	603.06							1.0	2.8			
09	101.09	-	11.1	28.5	4.3	8.6	11.4	6.35	4.0	2.7	-	-	-
	-	601.09							4.0	1.5			
	103.09	-		37.6	-	13.1		5.0	13.5	9.3	M3	0.94	1.5
	-	603.09							12.6	8.1			
13	101.13	-	14.3	35.6	5.6	10.4	14.8	8.0	14.3	5.7	-	-	-
	-	601.13							11.9	3.6			
	103.13	-		46.2	-	15.7		6.35	44.6	17.7	M3	0.94	1.5
	-	603.13							38.0	15.6			
16	101.16	-	17.5	53.3	8.9	15.2	23.0	11.0	32.3	12.2	-	-	-
	-	601.16							18.3	5.0			
	103.16	-		67.6	-	22.3		10.0	136	35.0	M4	2.27	2.0
	-	603.16							122	31.4			
20	105.20	-	23.0	62.0	8.0	17.0	28.0	12.7	147	25.7	-	-	-
25	105.25	-	28.5	74.0	10.0	20.0	34.0	14	463	56	-	-	-
32	105.32	-	36.5	86.0	10.0	21.0	44.0	20	1339	103	-	-	-

44

SINGLE JOINTS - PERFORMANCE (at 20°C)

Size	Brass Cross-piece 101, 103, 105				Plastic Cross-piece 601, 603				Max angular compensation @ 1000 rev/min	Max axial loading N
	Peak Torque Nm	Static Break Torque Nm	Torsional Rate deg/Nm	Torsional Stiffness Nm/Rad	Peak Torque Nm	Static Break Torque Nm	Torsional Rate deg/Nm	Torsional Stiffness Nm/Rad		
06	0.11	0.45	19.7	2.9	0.09	0.3	22	2.6	45	18
09	0.36	1.9	6.8	8.4	0.6	1.5	6.8	8.4	45	38
13	0.85	4.5	3.2	18	0.7	2.5	3.6	16.0	45	67
16	1.6	6.8	1.7	34	1.0	5.0	2.8	20.0	45	98
20	2.8	17	0.94	61	-	-	-	-	40	138
25	5.6	34	0.51	112	-	-	-	-	40	222
32	10.7	72	0.25	229	-	-	-	-	40	334

FOR STANDARD BORES SEE FACING PAGE

Materials & Finishes

Bodies: Acetal
 Cross-pieces: Brass BS 2874 CZ121 (101, 103, 109, 111)
 Nylon Glass filled (601, 603, 609, 611)
 Bore Inserts: Brass BS 2874 CZ121 (103, 111, 603, 611)
 Al. Alloy 2014A T6 or AIECO 62 Sn T9 (105)
 Fasteners: Alloy steel, black oiled

Operating Temperature Range

- 20°C to +60°C

Maximum Rotational Speed

1000 rev/min

Huco - Pol Plastic Universal Joints

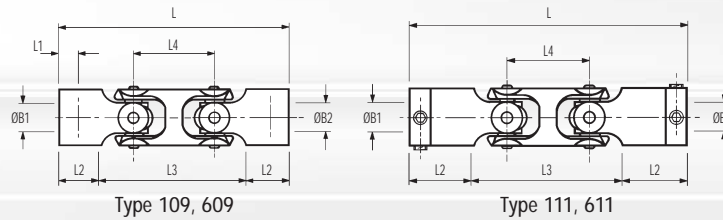

DOUBLE JOINTS - DIMENSIONS & ORDER CODES

Size	Cross-piece		Dimensions									Fasteners		
	1 Brass Cross-piece	2 Plastic Cross-piece	OD	L	L1	L2	L3	L4	B1, B2 Max	Moment of inertia kgm ² x 10 ⁻⁸	Mass kg x 10 ⁻³	Size	Torque (Nm)	A/F (mm)
Hub Ref														
06	109.06	-	7.1	27.2	3.3	5.3	16.7	8.1	4.76	0.6	1.1	-	-	-
	-	609.06								0.4	0.6			
	111.06	-		35.3	-	9.3			3.18	1.3	3.5	M3	0.94	1.5
	-	611.06								1.1	3.0			
09	109.09	-	11.1	41.7	4.3	8.6	24.6	13.2	6.35	5.9	4.5	-	-	-
	-	609.09								5.8	2.0			
	111.09	-		50.8	-	13.1			5.0	15.3	11.1	M3	0.94	1.5
	-	611.09								14.0	8.6			
13	109.13	-	14.3	51.4	5.6	10.4	30.7	15.9	8.0	23.7	9.6	-	-	-
	-	609.13								21.5	7.5			
	111.13	-		62.1	-	15.7			6.35	50.4	21.6	M3	0.94	1.5
	-	611.13								50.4	15.6			
16	109.16	-	17.5	75.5	8.9	15.2	45.2	22.2	11.0	63.5	19.7	-	-	-
	-	609.16								35.5	12.5			
	111.16	-		89.8	-	22.3			10.0	178.0	42.4	M4	2.27	2.0
	-	611.16								150.0	35.2			

SINGLE JOINTS - PERFORMANCE (at 20°C)

Size	Brass Cross-piece 109, 111				Plastic Cross-piece 609, 611				Max angular compensation @ 1000 rev/min	Max radial compensation mm
	Peak Torque Nm	Static Break Torque Nm	Torsional Rate deg/Nm	Torsional Stiffness Nm/Rad	Peak Torque Nm	Static Break Torque Nm	Torsional Rate deg/Nm	Torsional Stiffness Nm/Rad		
06	0.08	0.34	81.9	0.7	0.08	0.3	115	0.5	90	5.6
09	0.16	1.9	13.3	4.3	0.16	1.5	17.3	3.3	90	9.1
13	0.59	3.4	8.1	7.1	0.59	2.5	10.4	5.5	90	10.9
16	1.3	6.8	4.5	12.6	1.0	5.0	7.5	7.6	90	15.5

STANDARD BORES

Size	Bore tolerances 101, 601, 109, 609 = +0.04/-0.0mm • 103, 603, 111, 611 = +0.03/-0.0mm																		
	3	3.175	4	4.763	5	6	6.350	8	9.525	10	12	12.700	14	15.875	16	18	19	19.050	20
06	●	●	●	●															
09	○	○	●	●	●	●	●												
13			○	○	○	●	●	●											
16						○	○	●	●	●									
20								○	○	○		○							
25										○	○	○							
32													○	○	○	○	○	○	○
Bore Ref	14	16	18	19	20	22	24	28	31	32	35	36	38	41	42	45	46	47	48

● Moulded bores only ○ Sleeved bores only ● Moulded or sleeved bores available



Constant velocity

The velocity ratio of single universal joints is not constant when the working angle is greater than zero. Their geometry gives rise to sinusoidal fluctuations at the output that increase with the working angle and which vary between:

$$\omega \cos \beta \text{ and } \omega \sec \beta$$

where ω = angular velocity
and β = operating angle

For example, when the operating angle is 5°, the maximum error is $\pm 0.4\%$; at 7° it is $\pm 0.8\%$, and at 10° it is $\pm 1.5\%$. A motor shaft turning at a constant 1000 rpm, driving through a single universal joint set at an operating angle of 5°, produces an output that fluctuates between 996 rpm and 1004 rpm twice each revolution.

The fluctuations are cancelled out when using a double joint or two single joints connected back to back.

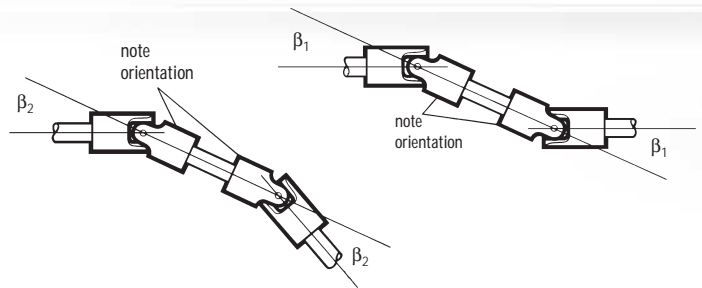

To maintain constant velocity ratio, ensure that:

- The orientation of two single joints is correct; the inboard forks should align as in double joints.
- The working angle of both joints, or both halves of a double joint, is the same.

ADJUSTED TORQUE

Peak torque values apply when the working angle is zero. Adjusted torque takes account of dynamic loading at the bearings. To find adjusted torque, determine application speed, torque and operating angle,

Then:

- multiply speed x working angle
- subtract the result from 10000
- divide the answer into 10000
- apply the result to the application torque.

eg. speed = 400 rpm
application torque = 0.1Nm
working angle = 20°

Accordingly:

- 400 rpm x 20° = 8000
- 10000 - 8000 = 2000
- 10000 / 2000 = 5
- 5 x 0.1Nm = 0.5Nm

Select a joint where Peak Torque exceeds 0.5Nm, ie., size 13 or larger.

Note: To remain within the capacity of the joint, the result of speed x working angle must be less than 10000.

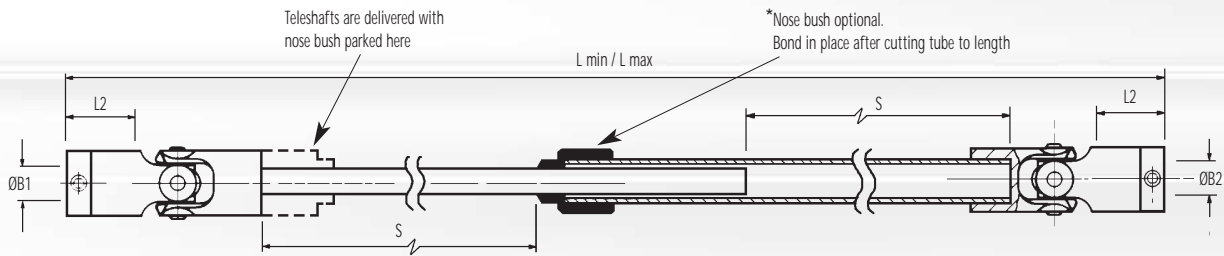
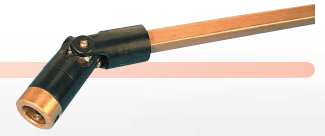

Refs. 128 & 495

Joints sleeved with headed brass inserts fitted 2 screws per end

End A
(inner tube)

End B
(outer tube)

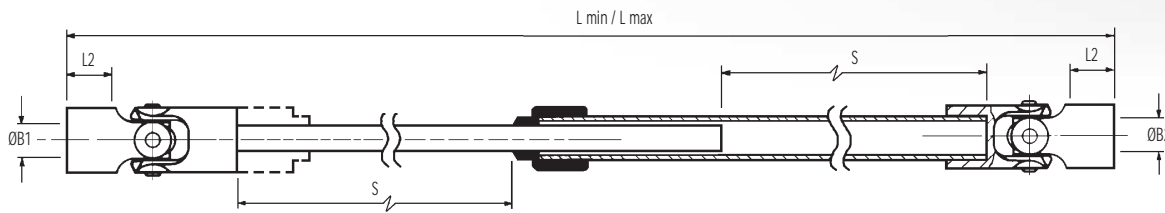

Refs. 130 & 497

Joints sleeved with metal inserts. Attach to shafts by cross-pinning or bonding

Typical

DIMENSIONS & ORDER CODES

Teleshafes size	Teleshafes options		ØD	L	L	Stroke	L2	ØB1, ØB2 max	Mass kg x 10 ⁻³	Corresponding joints.
	Standard tubes self-colour brass	Wear-resistant tubes Niflor coated								
	teleshafes REF									
09	128.09.240	495.09.240	11.1	240	389	149	13.1	5	36	103.09
13	128.13.300	495.13.300	14.3	300	484	184	15.7	6.35	58	103.13
16	128.16.450	495.16.450	17.5	450	730	280	22.3	10	168	103.16
20	130.20.464	497.20.464	23.0	464	745	281	17.0	12.70	241	105.20
25	130.25.500	497.25.500	28.5	500	784	284	20.0	14	457	105.25
32	130.32.564	497.32.564	36.5	564	868	304	21.0	20	827	105.32

- 1 Niflor is a proprietary PTFE impregnated electroless nickel plating process.
- 2 Max shaft penetration
- 3 Values apply with max bores.

- A range of standard telescopes is available which can be shortened to achieve an infinite number of length/stroke requirements. The lengths L min shown in the table above are the longest of the standard range in each size. Specific lengths are produced by cutting an equal amount from both ends of the nearest standard size. See next page for recommended procedure.
- Custom Teleshafes assemblies can be factory made subject to minimum order quantities.
- *The nose bush eliminates any torsional free play that may be apparent in the tubes due to working clearances.
- Full details of the standard range and product order codes are available on request. Please ask for a Huco Teleshafes data sheet.

STANDARD BORES

Teleshafes size	ØB1, ØB2 +0.03 / -0mm														
	3.175	4	4.763	5	6	6.350	8	9.525	10	12	12.700	15.875	16	19.050	20
09	●	●	●	●											
13		●	●	●	●	●									
16					●	●	●	●	●						
20								●	●						
25										●	●				
32												●	●	●	●
Bore ref.	16	18	19	20	22	24	28	31	32	35	36	41	42	47	48
Corresponding bore adaptor				251		253	255		257		259		260		261

Diameters for which a bore adaptor is shown can be adapted to smaller shaft sizes. See page 56 for details.

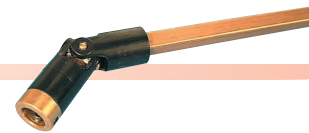

Extensible drive shafts (teleshfts), are useful when the distance between actuator and load varies during operation, or needs to accommodate component variances, or when a quick disconnect facility is needed in the drive line.

Huco teleshfts are in keeping with the light duty capabilities of plastics universal joints and employ precision drawn square brass tubes as the

telescoping medium. These can easily be cut by the user to provide an extensible drive shaft with customised dimensions.

There are 2 ways to arrive at a customised teleshft: empirically (shown below), or with tables that provide all necessary data on stroke and tube lengths for teleshfts with and without nose bushes up to 520mm retracted length.

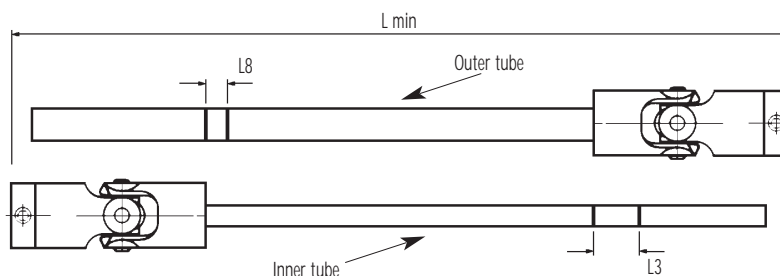

Size	L3	L8
09	8.6	3.2
13	10.4	4.3
16	15.2	6.1
20	17.0	8.2
25	20.0	10.3
32	21.0	18.0

Empirical method (based on the retracted length).

- Disengage the teleshft, remove the nose bush parked on the inner tube and keep it in case you need to use it later. Then lay the 2 halves of the teleshft side by side.
- Slide one half alongside the other so that overall length L_{min} matches the intended length of the teleshft when *fully retracted*. With a felt tip pen, draw a line across the outer tube at the point where this is level with the inboard end of the universal joint.
- If you are sure that the teleshft will satisfactorily extend the required amount, cut the tube at the line.
- Mark the inner tube in the same way, then add an amount equivalent to dimension $L3$ for your teleshft size and draw a second line. Cut the tube at this second line.

- Now re-engage the tubes, taking care to orientate them correctly so that the inboard forks of the joints are in the same plane, and retract the teleshft. The overall length should be as intended, and both tubes should bottom out simultaneously.
- If required, the nose bush can now be fitted by bonding it to the outer tube with an instant adhesive, (factory fitted bushes are retained by a barbing technique). The bush will add an amount equivalent to dimension $L8$ to the retracted length. Cutting this amount from the outer tube will reinstate the intended retracted length.
- The purpose of the nose bush is to eliminate any torsional free play that may be apparent in the tubes due to working clearances.

48

How to order customised teleshfts

Please specify your teleshft by completing the questionnaire.

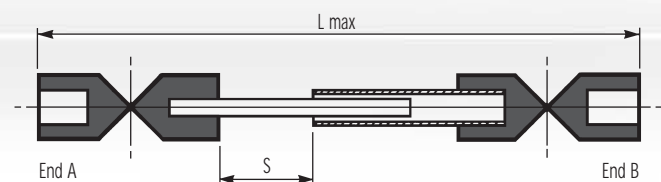
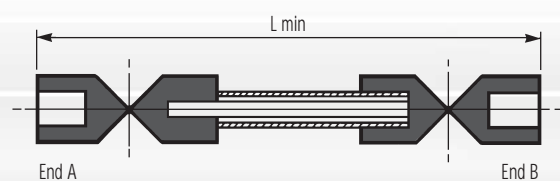

Teleshft size 09 13 16 20 25 32

Teleshft ref. 128 130 495 497

Bore diameter End A

Bore diameter End B

Fitted nose bush (end B only)

Speed of rotation rpm

Please specify:

L min and/or

L max and/or

Stroke S

If more than one parameter is specified, which one is critical?

Please quote pcs

Projected annual qtys pcs

adjustable friction clutches

Huco Vari-Tork are rotary friction devices with adjustable drag or slip torque. Controlled slip takes place between the hub and housing whenever the load exceeds the set torque.

- Three sizes - up to 3Nm torque capacity
- 4 interface styles
- Set screw or clamp connection
- Compact proportions
- Use as a torque limiter, tensioning, or overrun device

The construction is simple and robust and comprises a series of steel clutch plates engaging a hub and a series of friction rings engaging a housing. Pressure is brought to bear on the plates and friction rings by an adjuster acting through a spring and pressure plate. The load can be connected to either the steel inner hub or the aluminium alloy housing.

As a torque limiter, Vari-Tork interrupts continuity between power source and load when this reaches a pre-determined level.

As a tensioning device, Vari-Tork typically maintains tension in a filament or tape winding operation by exerting drag on the feed spool.

As an overrun device, Vari-Tork absorbs residual inertia of a motor when the load is braked or reaches a terminal stop.





Size 16 Set Screw Shaft Fixing

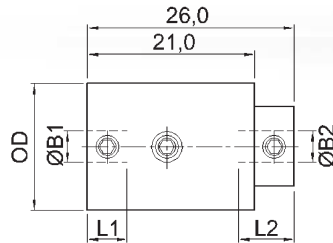

Size 25 Set Screw Shaft Fixing

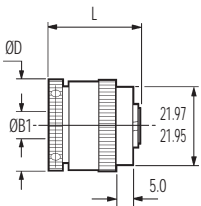

Ref. 271 (2 plate)
279 (6 plate)
Basic clutch (thro' bore)

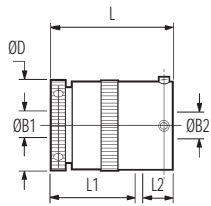

Ref. 273 (2 plate)
281 (6 plate)
Basic clutch + sleeve adaptor

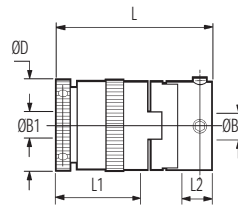

Ref. 277 (2 plate)
285 (6 plate)
Basic clutch + Oldham (set screw) coupling

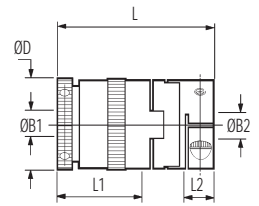

Ref. 267 (2 plate)
269 (6 plate)
Basic clutch + Oldham (clamp) coupling

Size 25 Clamp Shaft Fixing

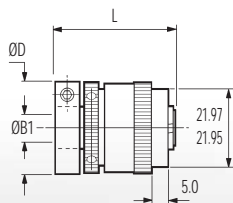

Ref. 401 (2 plate)
409 (6 plate)
Basic clutch (thro' bore)

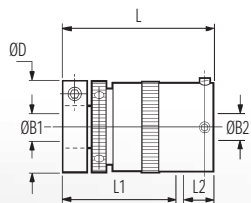

Ref. 403 (2 plate)
411 (6 plate)
Basic clutch + sleeve adaptor

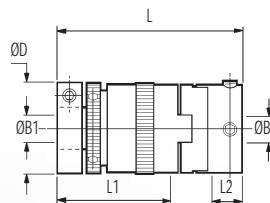

Ref. 407 (2 plate)
415 (6 plate)
Basic clutch + Oldham (set screw) coupling

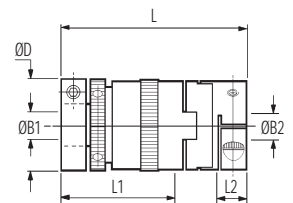

Ref. 397 (2 plate)
399 (6 plate)
Basic clutch + Oldham (clamp) coupling

Size 48 Set Screw Shaft Fixing

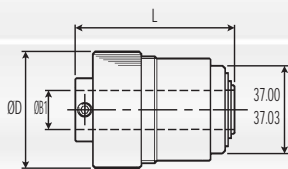

Ref. 279
Basic Clutch (thro' bore)

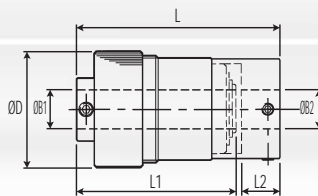

Ref. 281
Basic Clutch + sleeve adaptor

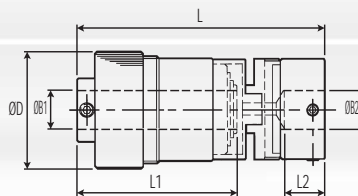

Ref. 285
Basic Clutch + Oldham (set screw) coupling

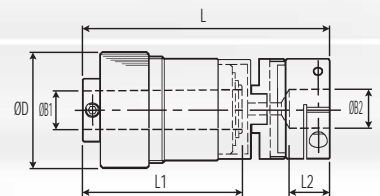

Ref. 269
Basic Clutch + Oldham (clamp) coupling

Materials & Finishes

Housing, adjuster ring, adaptors: Al. Alloy AEICO 62Sn T9
Irridite NCP finish

Hub: Steel, heat treated

Clutch plates: Size 25 Steel, heat treated
Size 48 Brass

Bearings: Sintered bronze

Fasteners: Alloy steel, black oiled

Vari-Tork Adjustable Friction Clutches



DIMENSIONS & ORDER CODES

Size & Model	Set Screw Hub	Clamp Hub	ØD	L	1 L1	2 L2	ØB1 max	Fasteners at B1 end			ØB2 max	Fasteners at B2 end			Max drag torque Ncm	Moment of inertia kgm ² x 10 ⁻⁸	Mass kg x 10 ⁻³
								Screw	Torque Nm	Wrench mm		Screw	Torque Nm	Wrench mm			
16	311.16	-	16.0	26.0	5.0	7.0	4	M3	0.94	1.5	4	M3	0.94	1.5	0.5	30	14
25 2-PLATE	267.25	-	25.8	46.5	25.0	8.6	8	M3	0.94	1.5	12	M3	2.43	2.5	53	416	58
	271.25	-		26.4	thro'	-					-	-	-	-		242	37
	273.25	-		36.0	25.0	9.0					12	M4	2.27	2		382	50
	277.25	-		46.5	25.0	8.6					12	M4	2.27	2		425	58
	-	397.25	54.5	33.0	8.6	12	M3	2.43	2.5	508	68						
	-	401.25	34.4	thro'	-	-	-	-	-	317	47						
	-	403.25	44.0	33.0	9.0	8	M3	2.43	2.5	12	M4	2.27	2	53	441	60	
	-	407.25	54.5	33.0	8.6	12	M4	2.27	2	511	69						
25 6-PLATE	269.25	-	25.8	53.4	31.0	8.6	8	M3	0.94	1.5	12	M3	2.43	2.5	132	529	68
	279.25	-		32.4	thro'	-					-	-	-	312		48	
	281.25	-		42.5	31.0	9.0					12	M4	2.27	2		451	60
	285.25	-		53.4	31.0	8.6					12	M4	2.27	2		516	69
	-	399.25	60.8	39.0	8.6	12	M3	2.43	2.5	617	79						
	-	409.25	40.7	thro'	-	-	-	-	-	381	58						
	-	411.25	50.3	39.0	9.0	8	M3	2.43	2.5	12	M4	2.27	2	132	530	71	
	-	415.25	60.8	39.0	8.6	12	M4	2.27	2	590	80						
48 6-PLATE	269.48	-	48.0	102.0	65.0	16.7	16	M6	7.60	3.0	20	M4	5.66	3	300	8037	390
	279.48	-		65.0	thro'	-					-	-	-	5548		278	
	381.48	-		83.0	65.0	16.0					20	M5	4.62	2.5		7135	350
	285.48	-		102.0	65.0	16.7					20	M5	4.62	2.5		8037	390

PERFORMANCE DATA

Size	Size 16	Size 25	Size 48
Power dissipation at 20°C 2-PLATE 6-PLATE	0.5 watt	7 watts 8.6 watts	18 watts
Backlash	0° max	2° max	zero
Max surface temperature	80° C	80° C	80° C
Max speed continuous slip	1000 rpm	1000 rpm	600 rpm

STANDARD BORES

		ØB1, ØB2 + 0.03/-0mm															
		4	6	6.350	7.938	8	9.525	10	12	12.700	14	15.875	16	18	19	19.050	20
Size 16	At B1 end	●															
	At B1 end	●															
Size 25	At B1 end		●	●	●	●											
	At B2 end		●	●	●	●	●	●	●								
Size 48	At B1 end					●	●	●	●	●	●	●	●				
	At B1 end						●	●	●	●	●	●	●	●	●	●	●
	Bore ref.	22	22	24	27	28	31	32	35	36	38	41	42	45	46	47	48
	Corresponding bore adaptor			253		255		257		259			260				261

Diameters for which a bore adaptor is shown can be adapted to smaller shaft sizes. See page 56 for details



How to install Vari-Tork

BASIC CLUTCH – REFS. 271, 279, 401 & 409
Controlled slip occurs between pulley and shaft.

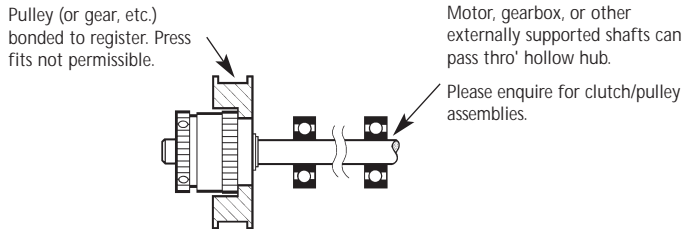

BASIC CLUTCH + SLEEVE ADAPTOR – REFS. 273, 281, 403 & 411
Controlled slip occurs between LH & RH shafts. Clutch orientation not important, supported shaft may be entered either end.

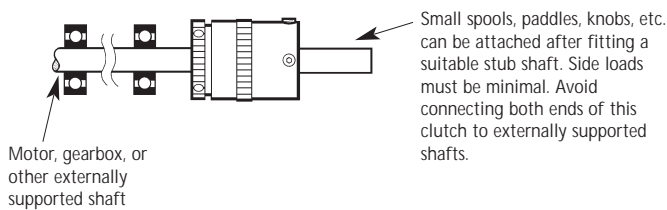

BASIC CLUTCH + FLEXIBLE COUPLING - REFS. 267, 269, 277, 285, 397, 399, 407 & 415 Controlled slip occurs between LH & RH shafts.

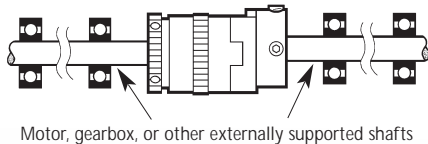

52

Locking ring

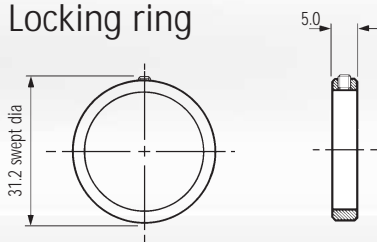

order ref.

294.25

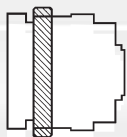

Fit locking ring flush with end of housing as shown. Lightly tension locking screw to secure the adjuster.
Wrench size 1.5

Construction - Size 25 Vari-Tork

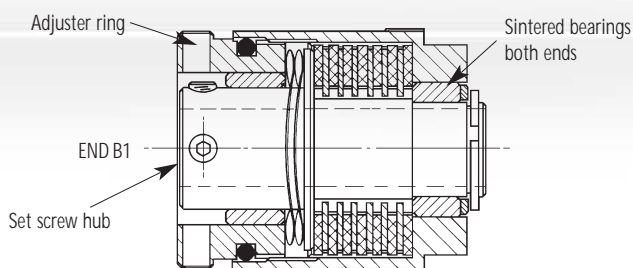

Sectional view of 6-plate Vari-Tork Ref. 279.25 Shafts are secured by set screws accessed through radial holes in the adjuster ring.

Vari-Tork characteristics

The characteristics of dry plate clutches favour those applications which can tolerate relatively imprecise drag torques. Three tendencies should be noted:

BREAKAWAY TORQUE

After a period during which no slipping has taken place, the breakaway torque can be up to 2^{1/2} times the set value.

TORQUE DECAY

There is an inverse relationship between clutch temperature and slipping torque. The slipping torque reduces from the set value as the power being dissipated causes the clutch temperature to rise. When slipping continuously, torque settles at approximately 70% of the value set on a new clutch and at approximately 80% of the value set on a used clutch. This characteristic is not speed-dependent.

SPEED RELATED TORQUE FLUCTUATIONS

Variations in slipping speed cause a momentary increase in the prevailing output torque. The clutches behave more consistently at high speed/low torque than at low speed/high torque. High speed in this instance starts at approximately 500 rpm.

Where applications call for sustained slipping, the housing temperature should be maintained below 80°C. Clutches mounted concentrically within pulleys, gear wheels, etc. will be more effective at dissipating heat generated during slipping.

CALCULATING FOR POWER DISSIPATION

Given the slipping speed in rpm and the drag torque in Nm, the following equation can be used for calculating the power dissipation in watts (W).

$$W = \frac{Nm \cdot rpm}{9.55}$$

Locking ring

In some circumstances it is possible for the adjuster ring to unscrew during operation. The adjuster ring can be secured by fitting locking ring ref. 294.25.

Removing the adjuster ring

- 1) If this should be necessary, be sure to replace the pressure plate first, then the spring washers. Ensure that the topmost friction ring is fully engaged with the splines. *A disengaged friction ring will cause the clutch to malfunction.*
- 2) To remove the adjuster ring, first remove the clamp. With set screw hubs the adjuster ring cannot be removed if the set screws protrude above the hub diameter. Flattening or dimpling of shafts is recommended and may be necessary with shafts larger than Ø6.35 to avoid the screws fouling the adjuster ring.

Waved washers

Two waved washers are fitted to these clutches. In some instances, better torque control may result from removing one of them, particularly when working in the lower torque ranges.

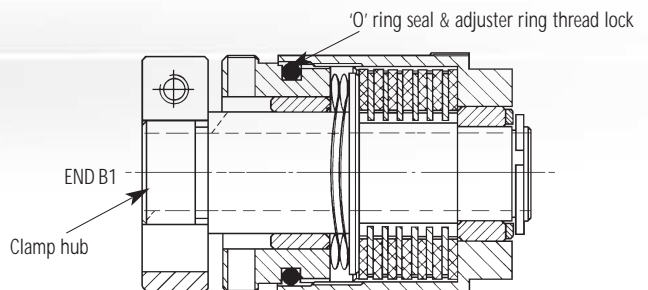

Sectional view of 6-plate Vari-Tork Ref. 409.25 Shafts are secured by a split hub and ring clamp method which does not score the shafts.

bevel gearboxes



Huco L-Box miniaturised right-angle drives offer 2 alternative specifications to meet the need for a standard component with differing levels of application and economy.

Both models feature two counterbored clearance holes for conventional chassis mounting and a tapped insert below each shaft for vertical mounting. Both models have a 1:1 ratio. Max backlash 2°.

Gear cases are injection moulded in filled Nylon 6.6 for low moisture take-up, low thermal expansion and rigidity.

Huco T-Box miniaturised right-angle drives offer 2 ratios and 3 shaft configurations. Features include:

Straight cut bevel gears, case hardened and cross-pinned to shafts.

Double shielded carbon steel deep groove input bearings.

Aluminium carriers precisely size the sintered output bearings and maximise heat dissipation.

Gear case injection moulded in filled Nylon 6.6 for low moisture take up, low thermal expansion and rigidity.

Ground steel shafts throughout, treated for hardness, strength and corrosion resistance.

Lifetime lubrication enhanced by grease control ribs.

Bevel Gearboxes

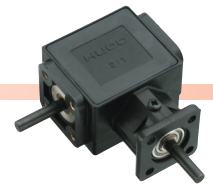

Huco L-Box

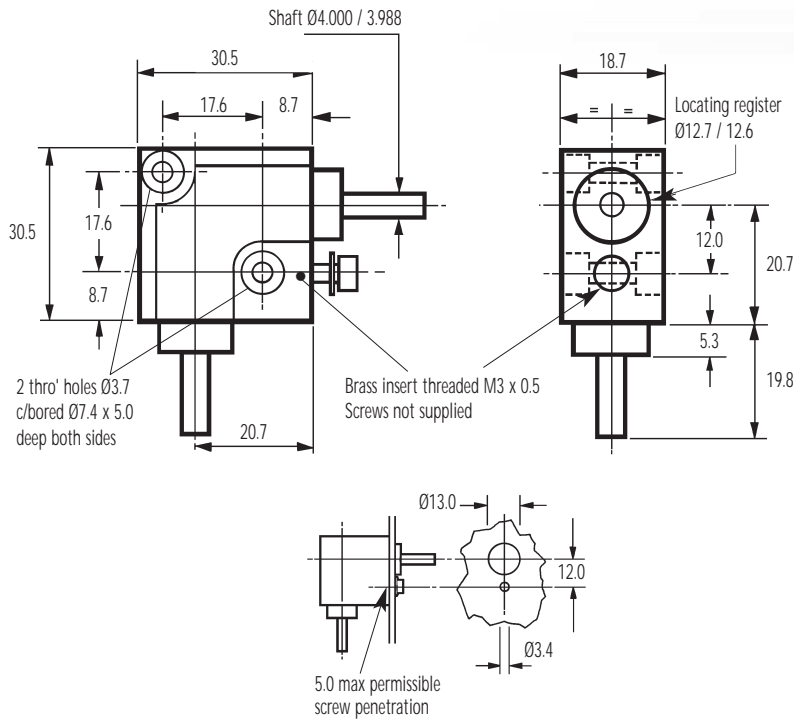

HUCO L-BOX REF. 332.31.2

Hardened steel gears bonded to ground and hardened steel shafts. Sintered bronze bearing system. Gearbox and bearings lubricated for life.

Electrical isolation between shafts and housing.

Suitable for manual, and short term drive applications.

Max torque 0.68 Nm.

Mass 41 g.

HUCO L-BOX REF. 333.31.3

Acetal gears moulded onto ground and hardened steel shafts. Sintered bronze bearing system. Gearbox and bearings lubricated for life.

Electrical isolation between input/output shafts and between shafts and housing.

Suitable for manual, and short term drive applications.

Max torque 0.11 Nm.

Mass 37 g.

Huco T-Box

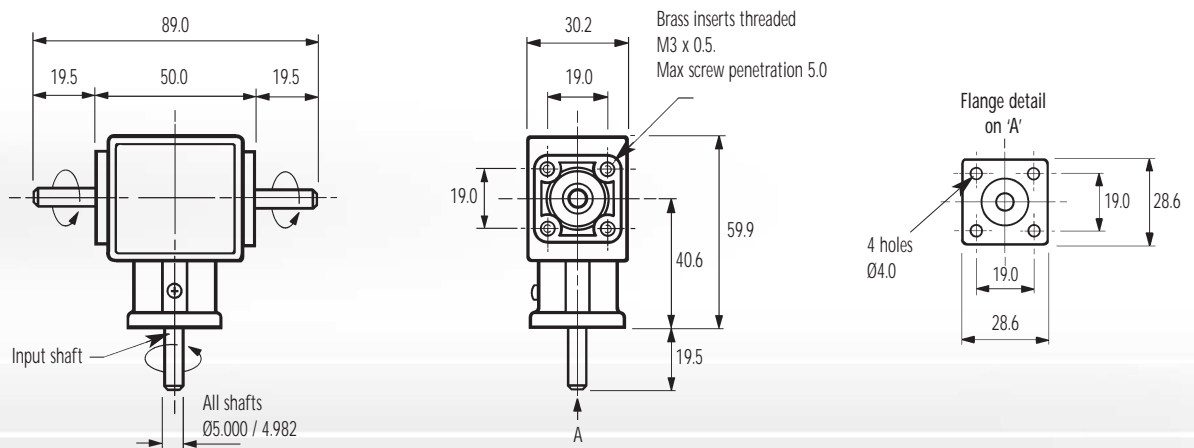

Alternative face mounting available (not shown). Please enquire for details

Configuration	Total nr. of shafts	Max input speed	Max power kW	Max backlash	Output torque Nm	Ratio	Mass g	T-Box ref.
	3	1500 rpm	0.053	2°	0.34	1:1	115	335.50.11
					0.68	2:1	130	335.50.12
	2	1500 rpm	0.053	2°	0.34	1:1	115	336.50.11
					0.68	2:1	130	336.50.12
	2	1500 rpm	0.053	2°	0.34	1:1	115	337.50.11
					0.68	2:1	130	337.50.12

To adapt shafts for larger bores, specify Huco-Lok adaptor 253.20 for Ø6.35 bores or 254.20 for Ø8 bores.

CAUTION

Gears may bind if gearbox is dropped on either of its shafts. Avoid endwise blows to shafts.

bore adaptors

Bore adaptors offer a convenient way of adapting a coupling to a variety of shaft diameters, typically at the R & D stage. A range of motor options, for example, can be accommodated with one coupling and a selection of Huco-Loks.

When fitted to set screw hubs, adaptors prevent the screws from scoring the shafts and permit repeated re-positioning and easy removal of the coupling.

The adaptors feature a feathered head which sits in the chamfer at the bore entry and prevents over-insertion.

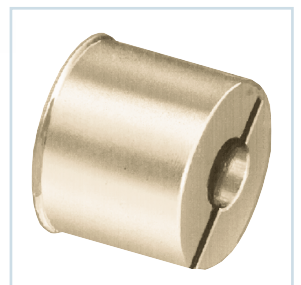
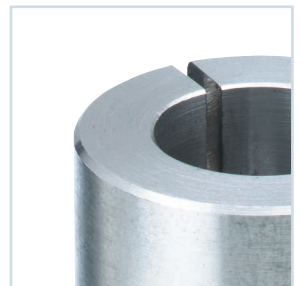
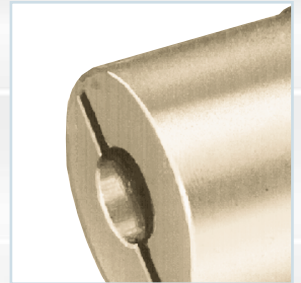

Huco-Lok Metallic (non insulating) & glass fibre (insulating) bore adaptors

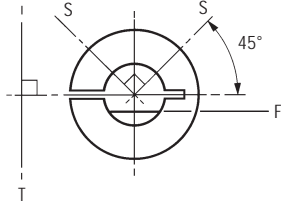
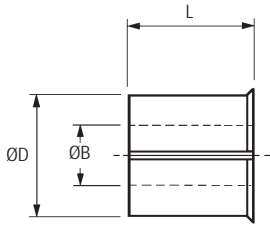

Bore For optimum fastening, install HUCO-LOK bore adaptors as shown.

'S' represents screws in set screw hub.

'T' represents tangential screw in clamp hub.

'F' shows recommended orientation of flatted shaft in set screw hub.

56

Note that both traction and concentricity may be affected when using an adaptor. For best results shafts with h6 tolerance or better, are recommended. Undersized shafts become progressively less effective. For similar reasons, flatted shafts with more than 1/4 of their diameter removed are not recommended.

Cat ref.	251	253	*254	255	257	259	260	261	262	263
ØD	5	6.35	8	8	10	12.7	16	20	25.4	28
L	4.3	6.6	5.8	8.1	8.1	10.7	13.2	20	20	25
to fit bores coded	20	24	28	28	32	36	42	48	53	54
minor ØB	Adaptor ref.									
2	251.11	253.11								
3	251.14	253.14	254.14	255.14						
3.048	251.15	253.15	254.15	255.15						
3.175	251.16	253.16	254.16	255.16						
4	251.18	253.18	254.18	255.18	257.18					
4.763		253.19	254.19	255.19	257.19					
5		253.20	254.20	255.20	257.20	259.20				
6			254.22	255.22	257.22	259.22	260.22			
6.350					257.24	259.24	260.24			
7					257.25	259.25	260.25			
7.938					257.27	259.27	260.27	261.27		
8					257.28	259.28	260.28	261.28		
9						259.30	260.30	261.30		
9.525						259.31	260.31	261.31	262.31	
10						259.32	260.32	261.32	262.32	
11							260.33	261.33	262.33	
12							260.35	261.35	262.35	263.35
12.700							260.36	261.36	262.36	263.36
14							260.38	261.38	262.38	263.38
15								261.40	262.40	263.40
15.875								261.41	262.41	263.41
16								261.42	262.42	263.42
18								261.45	262.45	263.45
19									262.46	263.46
19.050									262.47	263.47
20									262.48	263.48
22									262.49	263.49
22.225									262.50	263.50
24										263.51
25										263.52
25.400										263.53
material	brass				aluminium alloy					

Major diameter D is toleranced $-0.013 / -0.050\text{mm}$
 Minor diameter B is toleranced $+0.03 / -0\text{mm}$

* Short adaptor 254 is used with couplings as indicated in the standard bores tables. Use 255 for all other 8mm bores.

Formulae and Conversion Factors for Motion Transfer

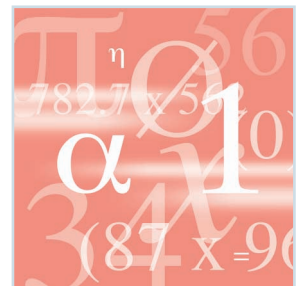
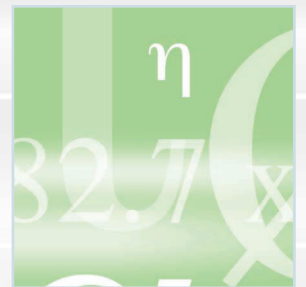

Formulae and Conversion Factors

SI base units

Quantity	Unit Symbol	Name
length	m	metre
mass	kg	kilogram
time	s	second
electric current	A	ampere
Thermodynamic temperature	K	kelvin
luminous intensity	cd	candela

Letter symbols and SI units in power transmission engineering

Symbol	Quantity	SI Unit Symbol	Name
Mechanics			
E	modulus of elasticity (Young's modulus)	Pa	pascal
F	force	N	Newton
G (W)	weight	N	Newton
J	moment of inertia	kgm ²	kilogram metre squared
M (T)	torque	Nm	Newton metre
m	mass	kg	kilogram
P	power	W	watt
p	pressure	Pa	pascal
ρ	density (mass density)	kg/m ³	-
σ	stress	Pa	pascal
W (E)	work (energy)	J	joule
η	efficiency	1	-
μ	coefficient of friction	1	-

58

Formulae

International System(SI)

Imperial System (FPS)

power

Lifting motion $P = \frac{m \cdot g \cdot v}{\eta \cdot 1000}$	Lifting motion $P = \frac{W \cdot v}{\eta \cdot 33000}$
Linear motion $P = \frac{F_r \cdot v}{1000}$	Linear motion $P = \frac{F_r \cdot v}{33000}$
$F_r = \mu \cdot m \cdot g$	$F_r = \mu \cdot W$
Rotary motion $P = \frac{M \cdot n}{9550}$	Rotary motion $P = \frac{M \cdot n}{5250}$
P - Power in kW	P - Power in hp
F _r - Frictional resistance in N	F _r - Frictional resistance in lb
m - Mass in kg	W - Weight in lb
g - Acceleration of free fall (9.81) in m/s ²	v - Velocity in ft/min
v - Velocity in m/s	η - Efficiency in decimals
η - Efficiency in decimals	μ - Coefficient of friction
μ - Coefficient of friction	M - Torque in lbf . ft
M - Torque in Nm	n - Rotational speed in rpm
n - Rotational speed in 1/min or r/min	

International System(SI)

Imperial System (FPS)

torque

$P = \frac{9550 \cdot P}{n}$	$P = \frac{5250 \cdot P}{n}$
M - Torque in Nm	M - Torque in lbf . ft
F - Force in N	F - Force in lbf
r - Radius of lever in m	r - Radius of lever in ft
P - Power in kW	P - Power in hp
n - Rotational speed in 1/min or r/min	n - Rotational speed in rpm

work

$W = \frac{j \cdot n^2}{182.5}$	$W = \frac{WK^2 \cdot n^2}{5880}$
W - Work (energy) in Nm = Ws = J	W - Work (energy) in lb . ft
F - Force in N	F - Force in lbf
s - Length of path in m	s - Length of path in ft
m - Mass in kg	
g - Acceleration of free fall (9.81) in m/s ²	
J - Moment of inertia in kgm ²	WK ² -Flywheel effect lb . ft ²
n - Rotational speed in 1/min or r/min	n - Rotational speed in rpm

acceleration or braking time

$t_a = \frac{J \cdot n}{9.55 \cdot M_a}$	$t_a = \frac{WK^2 \cdot n}{308 \cdot M_a}$
t _a - Acceleration or braking time in s	t _a - Acceleration or braking time in s
J - Moment of inertia in kgm ²	WK ² -Flywheel effect in kgm ²
n - Rotational speed in 1/min or r/min	n - Rotational speed in rpm
M _a - Acceleration or braking torque in Nm	M _a - Acceleration or braking torque in lb . ft

moment of inertia

Solid Cylinder $J = \frac{1}{2} \cdot m \cdot r_{ext}^2$ $= \frac{1}{32} \cdot 1000 \cdot \pi \cdot \rho \cdot l \cdot d_{ext}^4$ $= 98 \rho \cdot l \cdot d_{ext}^4$	Solid Cylinder $WK^2 = \frac{1}{2} \cdot W \cdot r_{ext}^2$ $= \frac{\pi}{32} \cdot \rho \cdot l \cdot d_{ext}^4$ $= 0.1 \rho \cdot l \cdot d_{ext}^4$
Hollow Cylinder $J = \frac{1}{2} \cdot m \cdot (r_{ext}^2 + r_{int}^2)$ $= \frac{1}{32} \cdot 1000 \cdot \pi \cdot \rho \cdot l \cdot (d_{ext}^4 - d_{int}^4)$ $= 98 \cdot \rho \cdot l \cdot (d_{ext}^4 - d_{int}^4)$	Hollow Cylinder $WK^2 = \frac{1}{2} \cdot W \cdot (r_{ext}^2 + r_{int}^2)$ $= \frac{\pi}{32} \cdot \rho \cdot l \cdot (d_{ext}^4 - d_{int}^4)$ $= 0.1 \cdot \rho \cdot l \cdot (d_{ext}^4 - d_{int}^4)$

torsional stiffness and resonant frequency

$$C_T \leq \frac{(F_R \times 2 \pi)^2}{\left(\frac{1}{J_M} + \frac{1}{J_L}\right)} \quad FR \leq \frac{1}{2 \pi} \times \sqrt{\left(\frac{1}{J_M} + \frac{1}{J_L}\right)} \times C_T$$

Where
 C_T = torsional stiffness (Nm/rad);
 J_M = motor inertia (kgm²)
 F_R = resonant frequency (Hz)
 J_L = load inertia (kgm²)

Formulae and Conversion Factors

force

		N	kp	p	tonf (UK)	lbf	ozf
1N	=	1	0.1020	102.0	100.4×10^{-6}	0.2248	3.597
1kp	=	9.807	1	1000	0.984×10^{-3}	2.205	35.27
1p	=	9.81×10^{-3}	1×10^{-3}	1	0.984×10^{-6}	2.2×10^{-3}	35.3×10^{-3}
1tonf (UK)	=	9964	1016	1.02×10^6	1	2240	35.8×10^3
1lbf	=	4.448	0.4536	453.6	0.5×10^{-6}	1	16
1ozf	=	-	28.4×10^{-3}	28.35	27.9×10^{-6}	62.5×10^{-3}	1

velocity

		km/h	m/min	m/s	mile/h	ft/min	ft/s	in/s
1km/h	=	1	16.667	0.2778	0.6214	54.68	0.9113	10.936
m/min	=	0.06	1	16.7×10^{-3}	37.3×10^{-3}	3.281	54.7×10^{-3}	0.656
1m/s	=	3.6	60	1	2.237	196.85	3.281	39.37
1mile/h	=	1.609	26.82	0.4470	1	88	1.467	17.6
1ft/min	=	18.3×10^{-3}	0.3048	5.08×10^{-3}	11.4×10^{-3}	1	16.7×10^{-3}	0.2
1ft/s	=	1.097	18.288	0.3048	0.6818	60	1	12
1in/s	=	91×10^{-3}	1.524	25.4×10^{-3}	56.8×10^{-3}	5	83.3×10^{-3}	1

torque

		Nm	Ncm	kgfm	lbf.ft	lbf.in	ozf.in
1Nm	=	1	100	0.10197	0.73756	8.8507	141.61
Ncm	=	0.01	1	1.02×10^{-3}	7.376×10^{-3}	88.5×10^{-3}	1.4161
1kgfm	=	9.8067	980.67	1	7.233	86.796	1389
1lbf.ft	=	1.356	135.6	0.1383	1	12	192
1lbf.in	=	0.1129	11.29	11.5×10^{-3}	83.3×10^{-3}	1	16
1ozf.in	=	7.062×10^{-3}	0.7062	0.72×10^{-3}	5.21×10^{-3}	62.5×10^{-3}	1

power

		kW	PS	hp	kgfm/s	ft.lbf/s
1kW	=	1	1.360	1.341	102.0	737.6
1PS	=	0.7355	1	0.9863	75	542.5
1hp	=	0.7457	1.014	1	76.04	550
1kgfm/s	=	9.81×10^{-3}	13.33×10^{-3}	13.15×10^{-3}	1	7.233
1ft.lbf/s	=	1.36×10^{-3}	1.84×10^{-3}	1.82×10^{-3}	0.1383	1

moment of inertia and other flywheel effects

		kgm ² (mr ²)	kgfm ² (GD ²)	lb.ft ² (WK ²)	kpms ²	ft lbf s ²
1kgm ² (mr ²)	=	1	4	23.73	0.102	0.7376
1kgfm ² (GD ²)	=	0.25	1	5.933	25×10^{-3}	0.1844
1lb.ft ² (WK ²)	=	42.1×10^{-3}	0.1686	1	4.30×10^{-3}	31.1×10^{-3}
1kpms ²	=	9.807	39.23	232.7	1	7.233
1ft lbf s ²	=	1.356	5.423	32.17	0.1383	1

length

	mm	m	in	ft	yds	km	miles
1mm	1	0.001	0.3937	0.0033	0.00109	-	-
1m	1000	1	39.370	3.2808	1.0936	0.001	0.0006215
1in	25.4	0.0254	1	0.0833	0.0277	0.0000254	0.0000158
1ft	304.8	0.3048	12	1	0.3333	0.000304	0.0001894
1yd	914.4	0.9144	36	3	1	0.000914	0.000568
1km	-	1000	39,370.07	3,280.83	1,093.613	1	0.6215
1mile	-	1,609	63,346.45	5,278.87	1,759.623	1.609	1



Huco Engineering Industries Ltd
Merchant Drive
Hertford
Hertfordshire SG13 7BL
T: +44 (0)1992 501900
F: +44 (0)1992 500035
E: sales@huco.com
W: www.huco.com