

LOC		DIST		REVISIONS			
P	LTN	DESCRIPTION	DATE	DWN	APVD		
A2		REVISED PER ECR-14-002441	25FEB2014	NK	GJ		

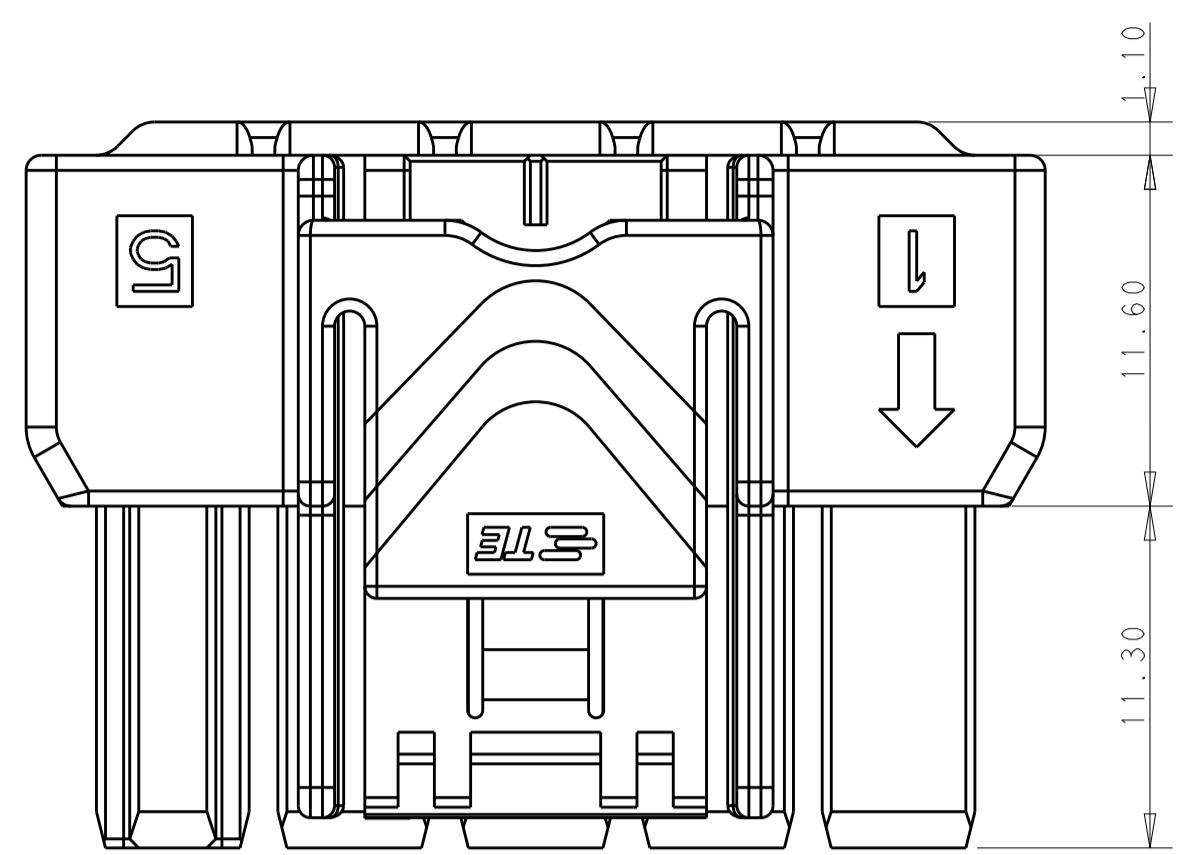

POS.	DIM. A
3*5	33.70
3*4	27.70
3*3	21.70

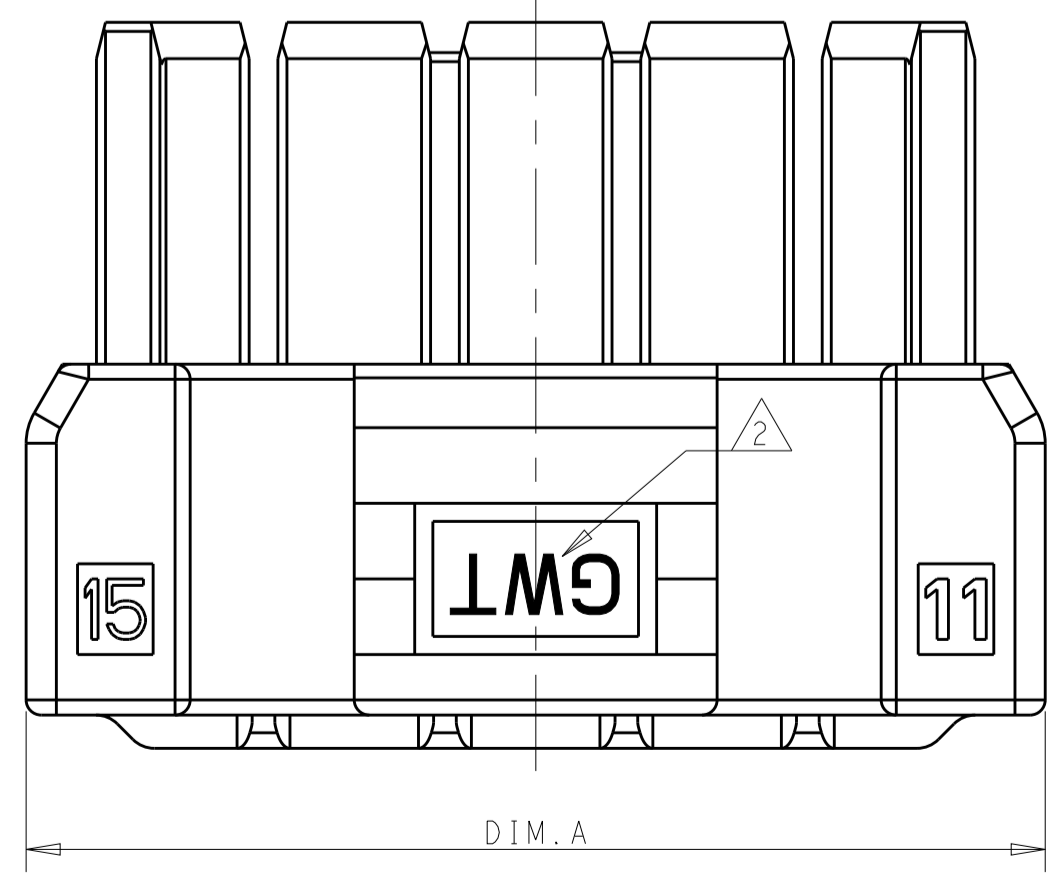
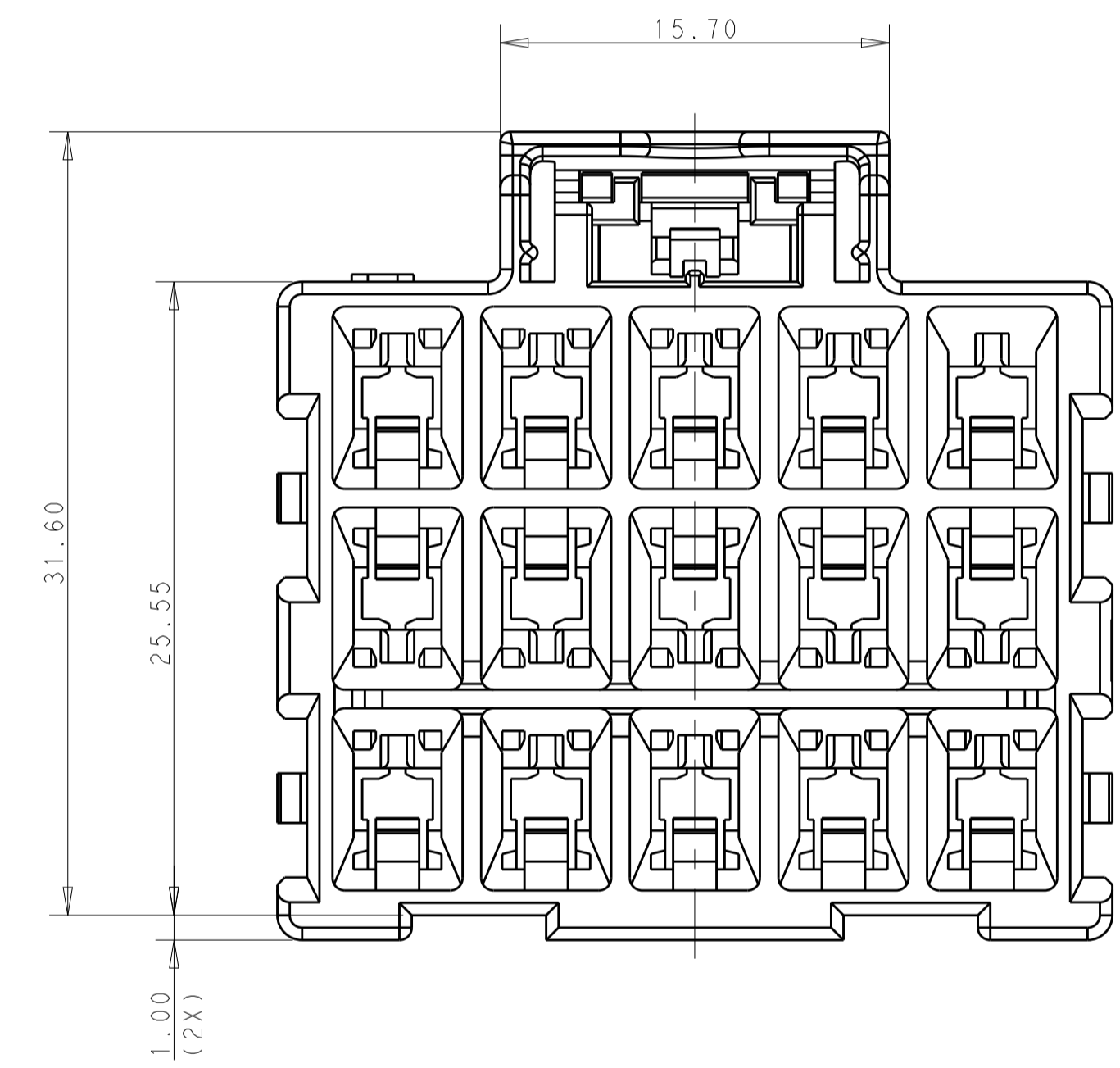
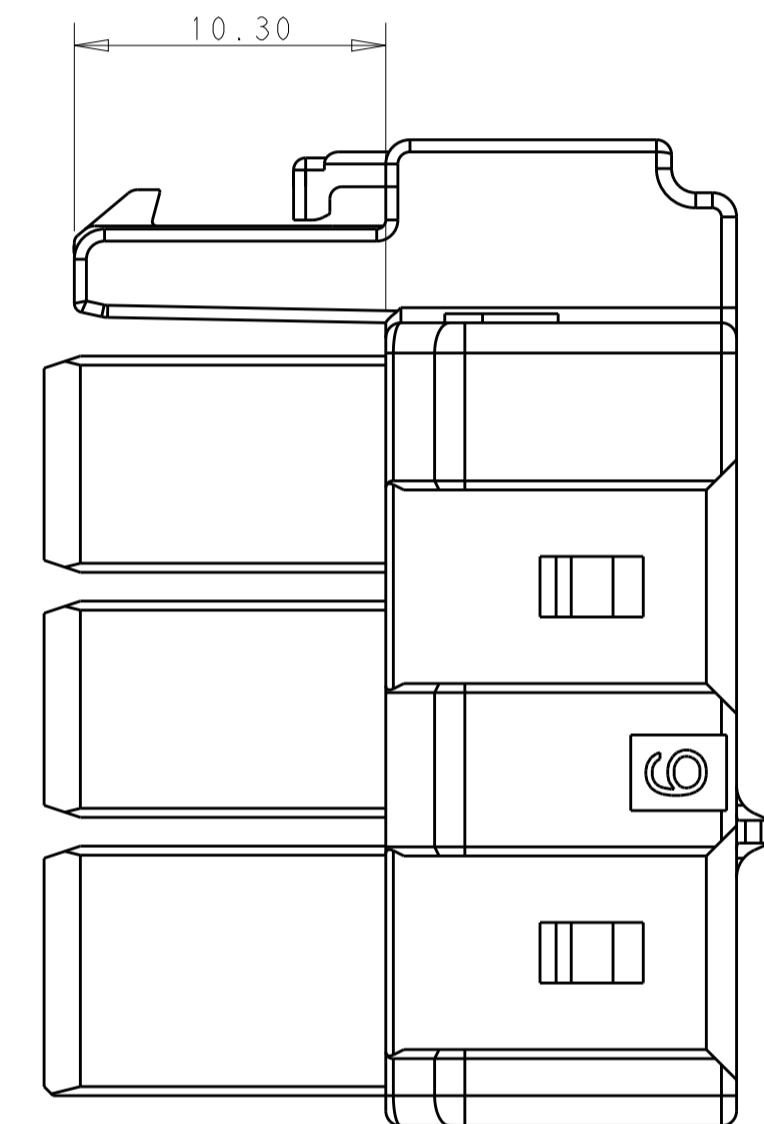
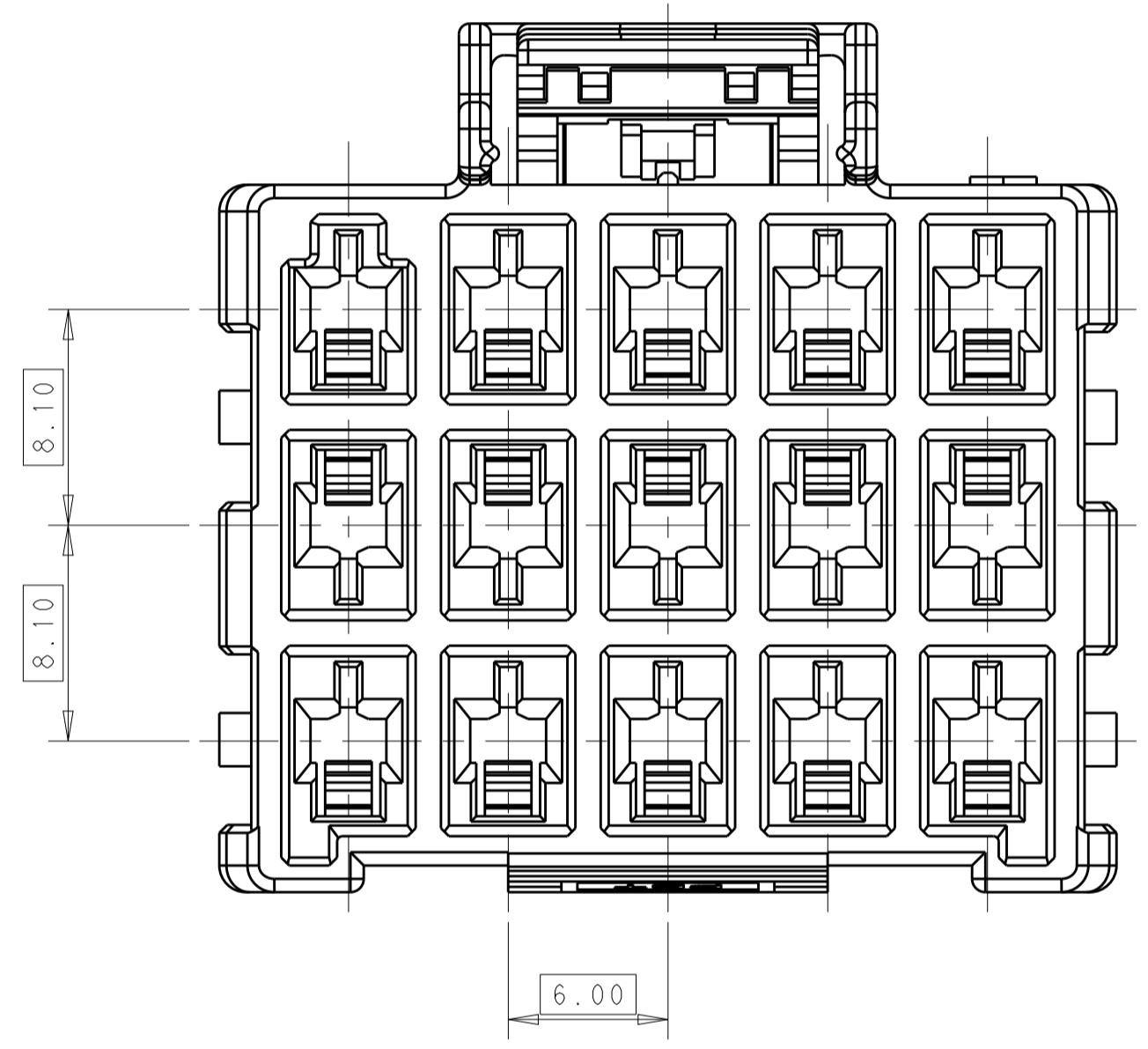

- MATERIAL:
 LEVEL A: PA6, COMPLY WITH GLOW WIRE REQUIREMENTS FOR PARTS OF NON-METALLIC MATERIAL SUPPORTING A CURRENT-CARRYING CONNECTION DETAILED IN IEC 60335-1, SECTION 30 (GWT), UL 94V-0
 LEVEL B: PBT, HOT WIRE IGNITION (HWI) VERSION ARE MOLDED IN A RESIN THAT COMPLIES WITH TE HOT WIRE IGNITION TEST 109-32026 AND ARE RECOMMENDED FOR USE WITH HWI HOUSINGS THAT ALSO COMPLY, UL 94V-0
- MATERIAL MARK:
 LEVEL A: GWT, LEVEL B: HWT
- APPLICABLE CONTACT P/N
 REC CONTACT: 1971237/1971779/81/83/85/87-*
- MATING CONN. P/N
 CAP HSG: *-2232356/60-*,
 DOUBLE ROW LOCK PLATE: *-1971778-*, SINGLE ROW LOCK PLATE: *-1971777-*
- PRELIMINARY - NOT FOR PRODUCTION.
- THIS PRODUCT HAS NOT COMPLETED VALIDATION TESTING.

THIS DRAWING IS A CONTROLLED DOCUMENT.		DWN: TOMMY_WU 26MAR2013	TE Connectivity PLUG HOUSING, TRIPLE ROW POWER TRIPLE LOCK
DIMENSIONS:		CHK: HAPYE_WU 26MAR2013	
TOLERANCES UNLESS OTHERWISE SPECIFIED:		APVD: YUJHONG_MAO 26MAR2013	
mm		NAME: YUJHONG_MAO	
0 PLC	±	PRODUCT SPEC	SIZE: CAGE CODE DRAWING NO
1 PLC	±0.35	108-106118	RESTRICTED TO
2 PLC	±0.25	APPLICATION SPEC	A100779C=2232357
3 PLC	±		SCALE
4 PLC	±		SHEET 1 OF 2
ANGLES	±		REV A2
MATERIAL	FINISH	WEIGHT	Customer Drawing

REVISES		DATE	OWN	APVD
LOC	DIST			
-	-			
-SEE SHEET 1-				

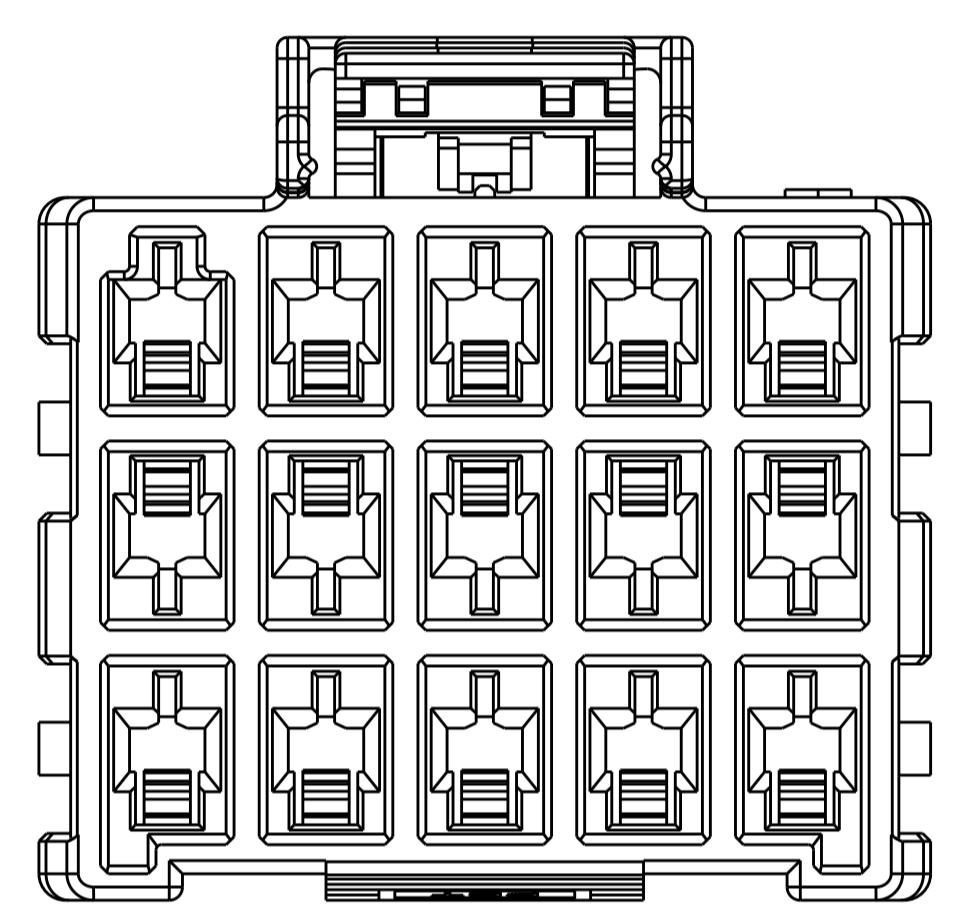
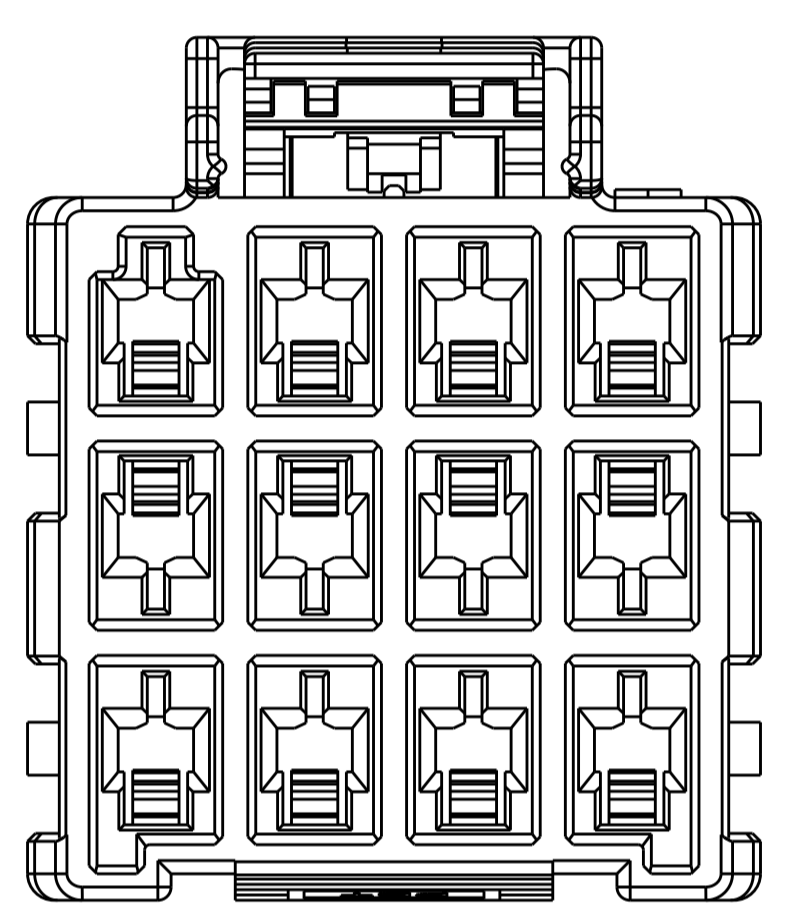
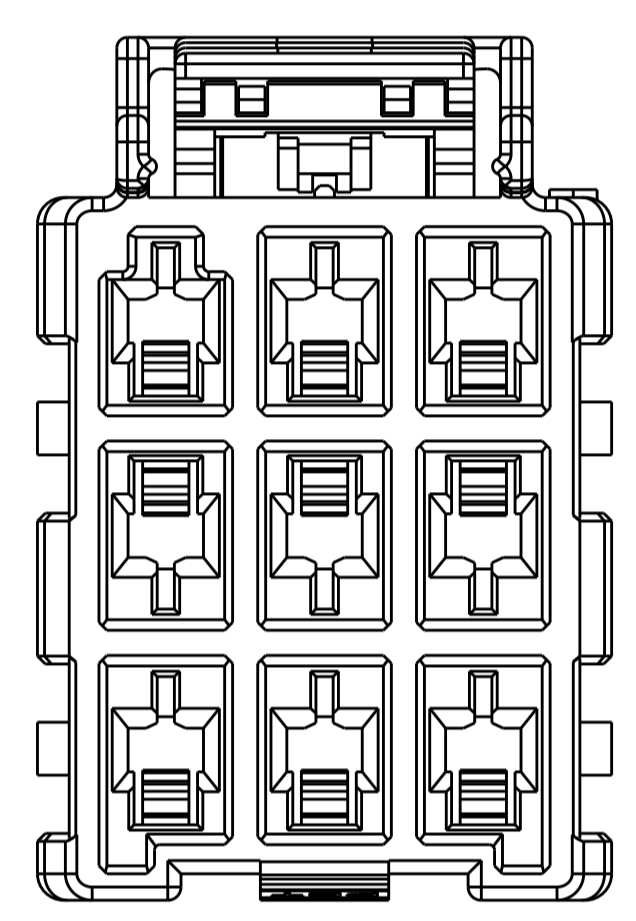
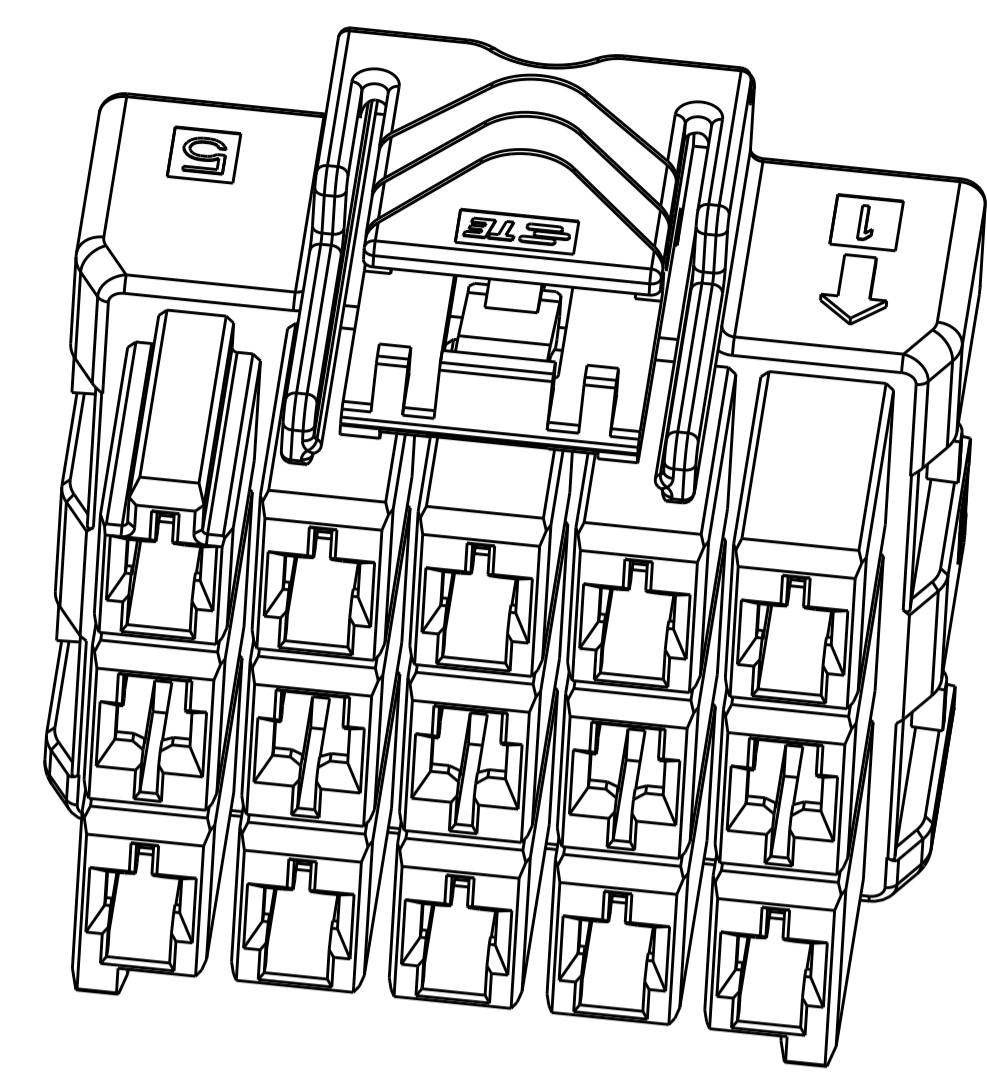
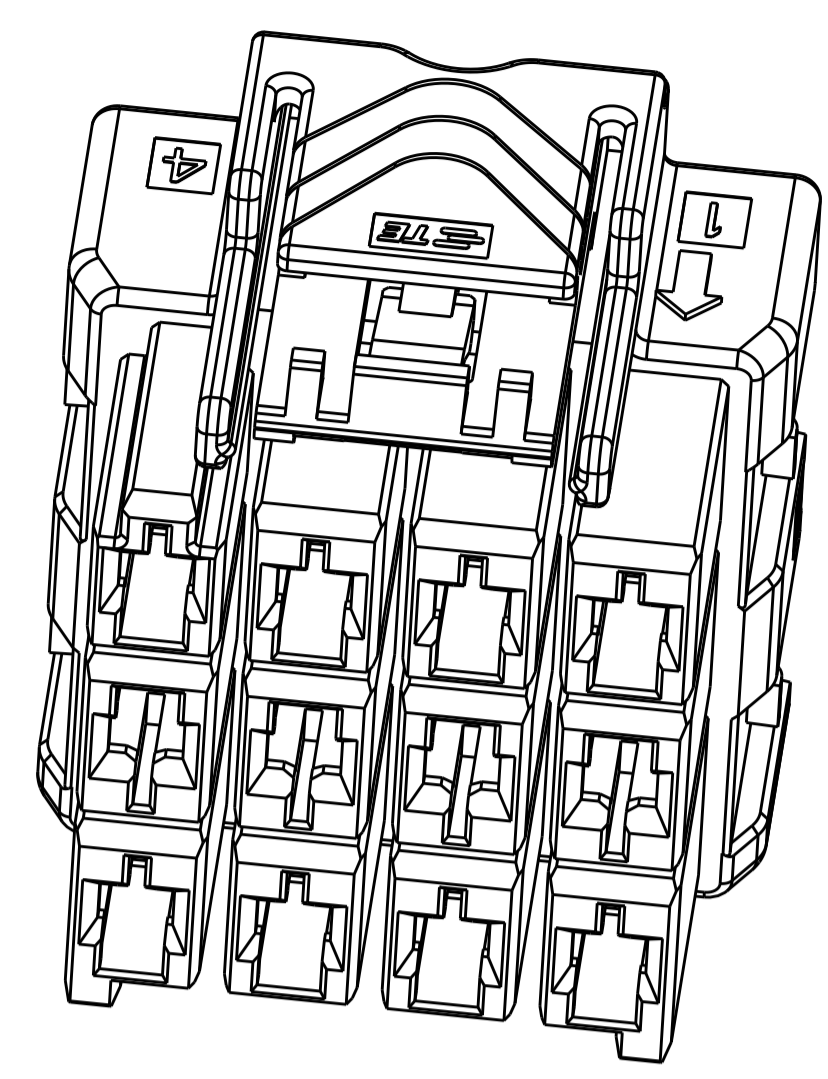
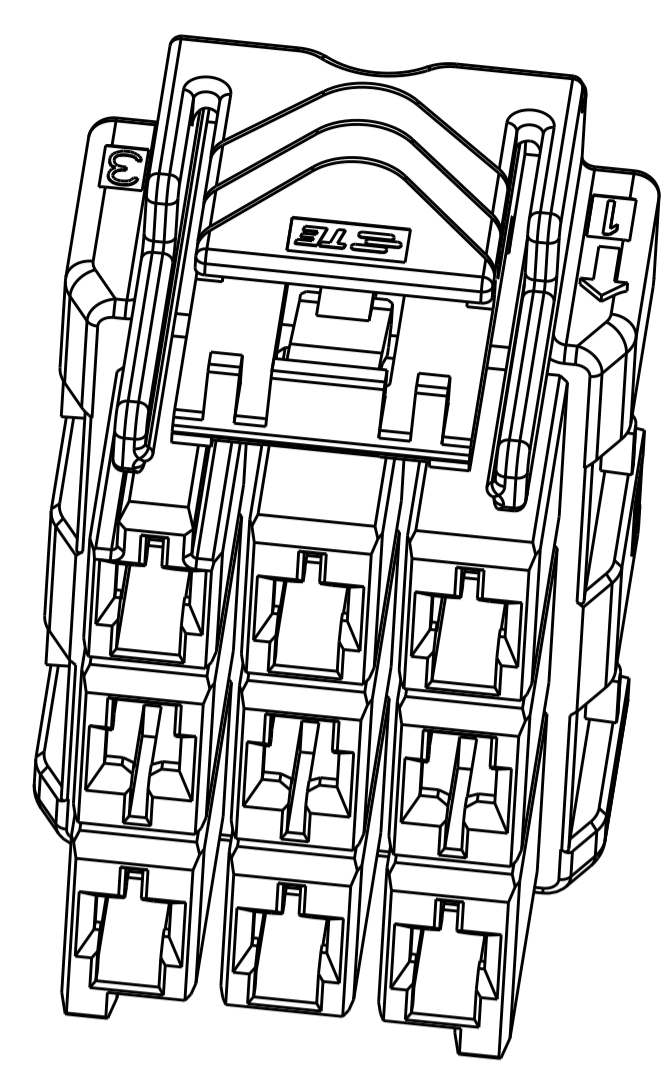

POS.	MATERIAL	COLOR	KEY	P/N
3*5	LEVEL A	DARK GREY	KEY A	5-2232357-7
		BROWN	KEY B	6-2232357-7
		GREEN	KEY C	7-2232357-7
		ORANGE	KEY D	8-2232357-7
3*4	LEVEL B	BLACK	KEY A	1-2232357-5
		DARK GREY	KEY A	5-2232357-4
		BROWN	KEY B	6-2232357-4
		GREEN	KEY C	7-2232357-4
3*3	LEVEL A	ORANGE	KEY D	8-2232357-4
		BLACK	KEY A	1-2232357-4
		DARK GREY	KEY A	5-2232357-3
		BROWN	KEY B	6-2232357-3
3*3	LEVEL B	GREEN	KEY C	7-2232357-3
		ORANGE	KEY D	8-2232357-3
		BLACK	KEY A	1-2232357-6
		BLACK	KEY A	1-2232357-6

3*3 POSITIONS

3*4 POSITIONS

3*5 POSITIONS

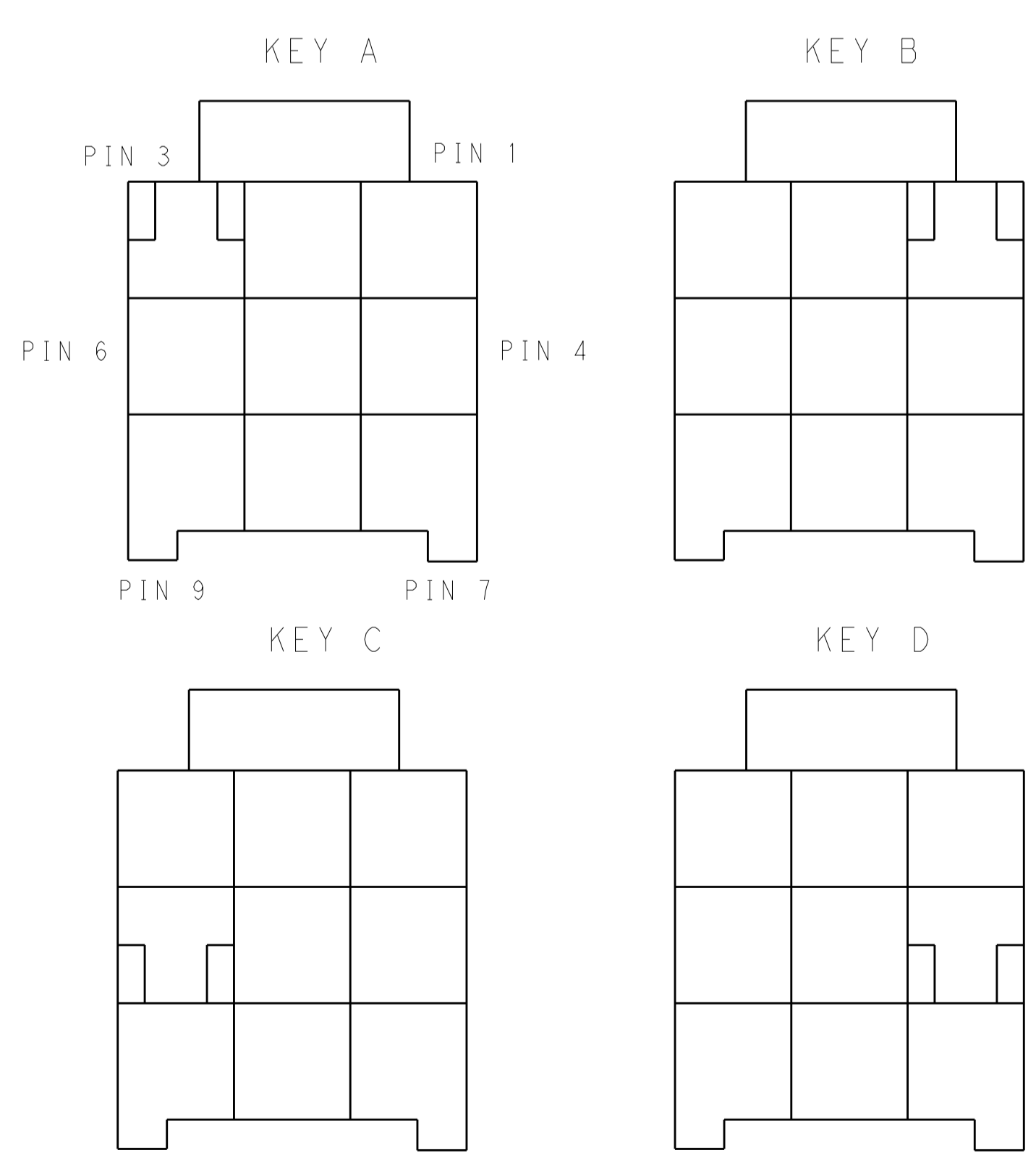

KEYING FOR 3*3 POS.

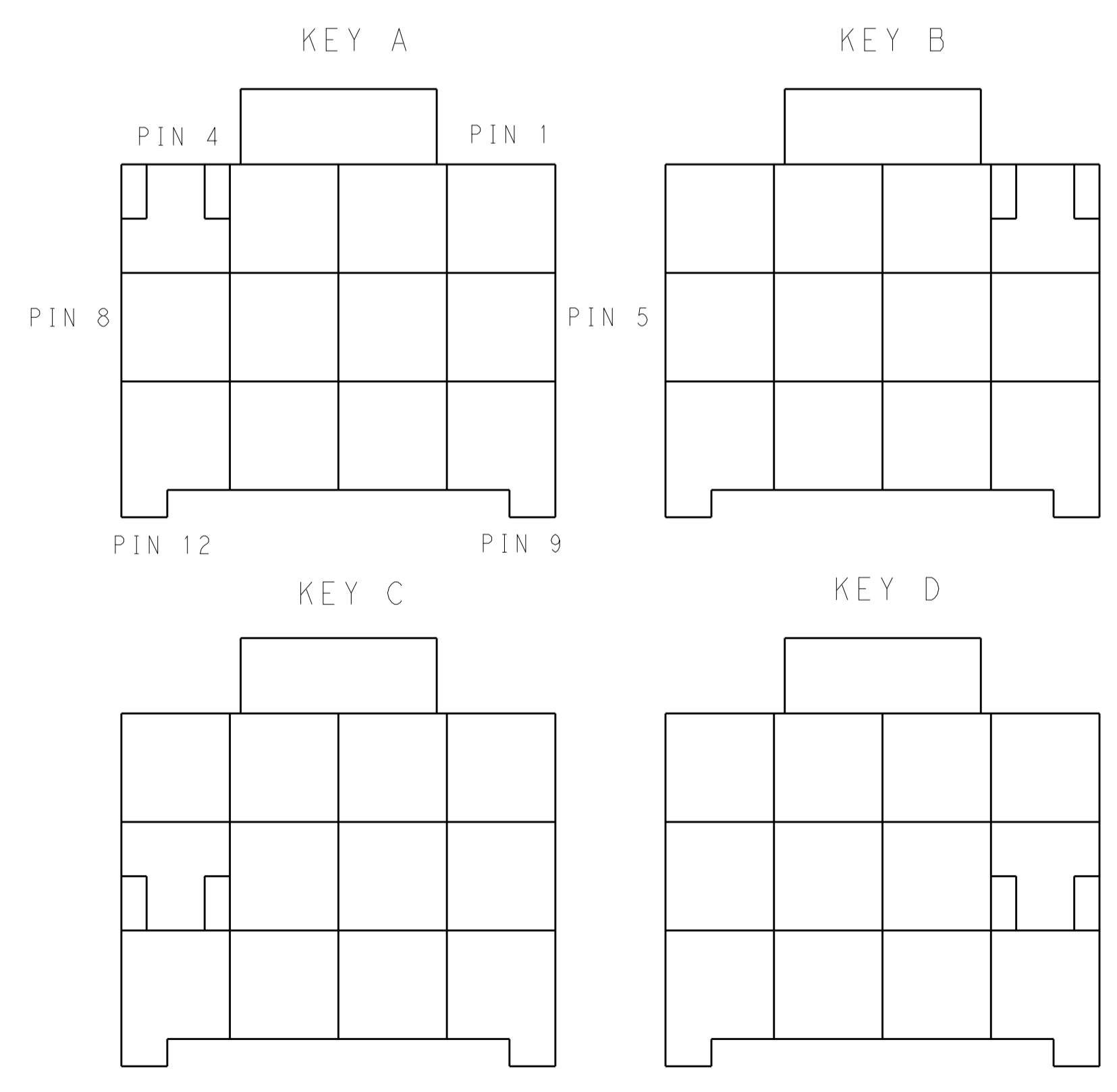

KEYING FOR 3*4 POS.

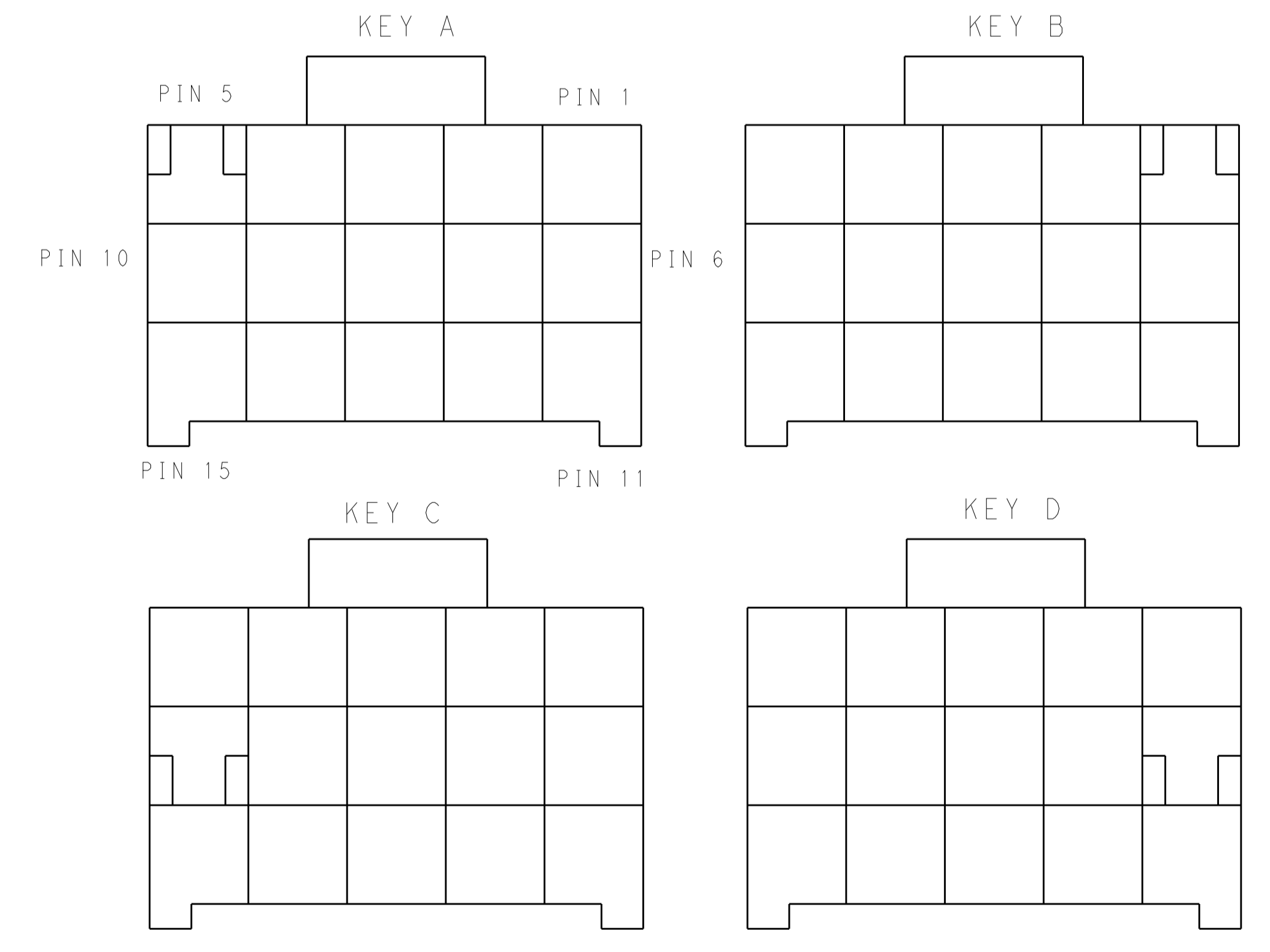

KEYING FOR 3*5 POS.

THIS DRAWING IS A CONTROLLED DOCUMENT.

DIMENSIONS:	TOLERANCES UNLESS OTHERWISE SPECIFIED:	OWN: TOMMY_WU 26MAR2013	CHK: HAPYE_WU 26MAR2013	APVD: YIHONG_MAO 26MAR2013
mm	0 PLC ±.1	NAME: PLUG HOUSING, TRIPLE ROW POWER TRIPLE LOCK		
	1 PLC ±0.35	SIZE: A1		
	2 PLC ±0.25	CAGE CODE: 108-106118		
	3 PLC ±.1	DRAWING NO: 114-106118		
	4 PLC ±.1	WEIGHT: -		
	ANGLES ±.1	SCALE: -		
MATERIAL:	FINISH:	SHEET 2 OF 2		
		REV A2		

Customer Drawing