

Aug.1.2016 Copyright 2016 HIROSE ELECTRIC CO., LTD. All Rights Reserved.

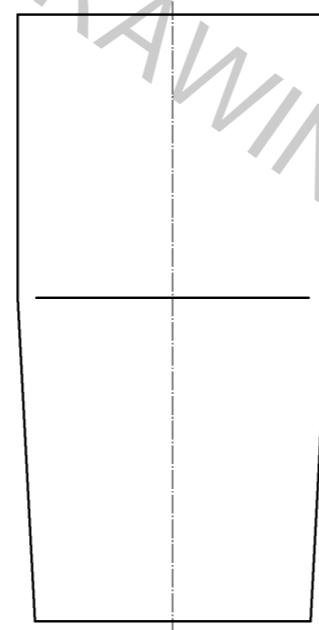

1 FIGURE-1 CONTACT No. MARKING (10:1)

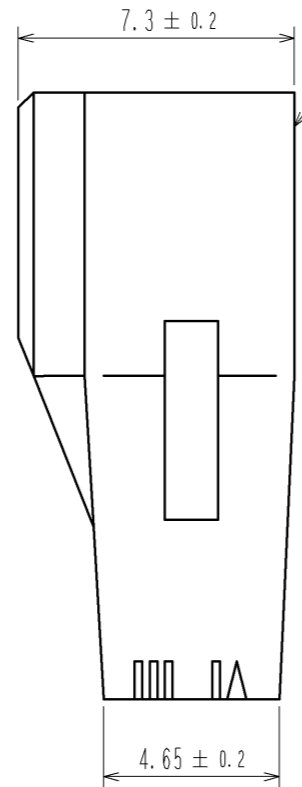
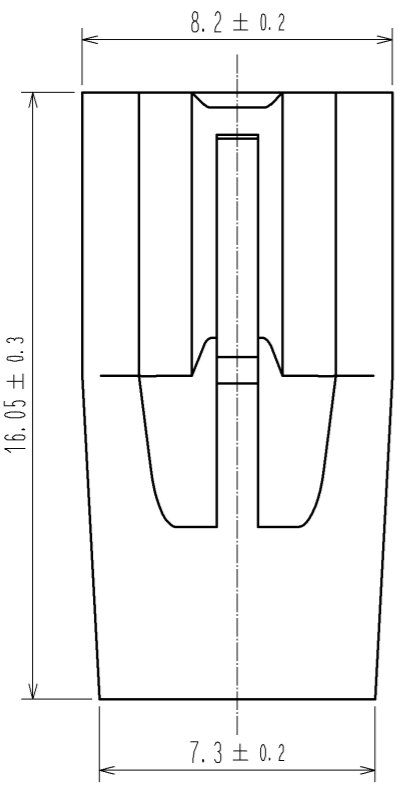
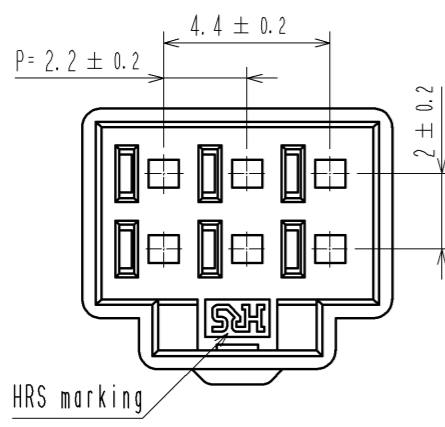
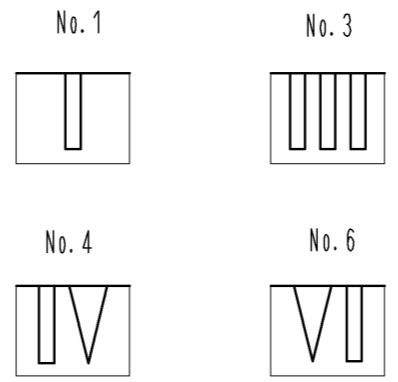

Mating figure

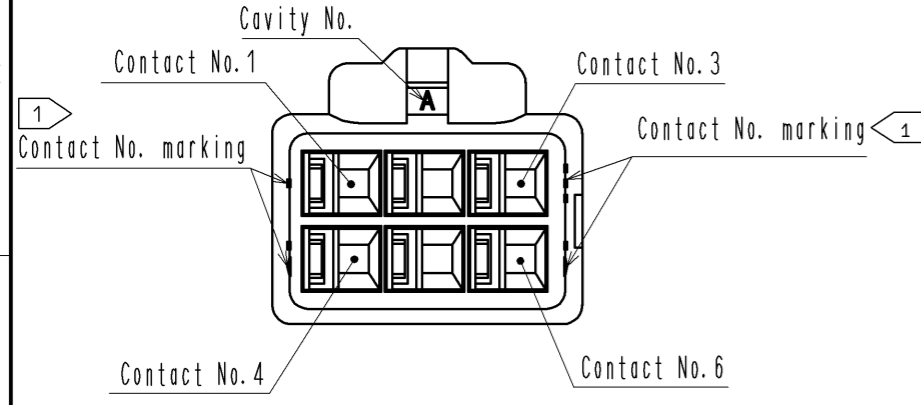
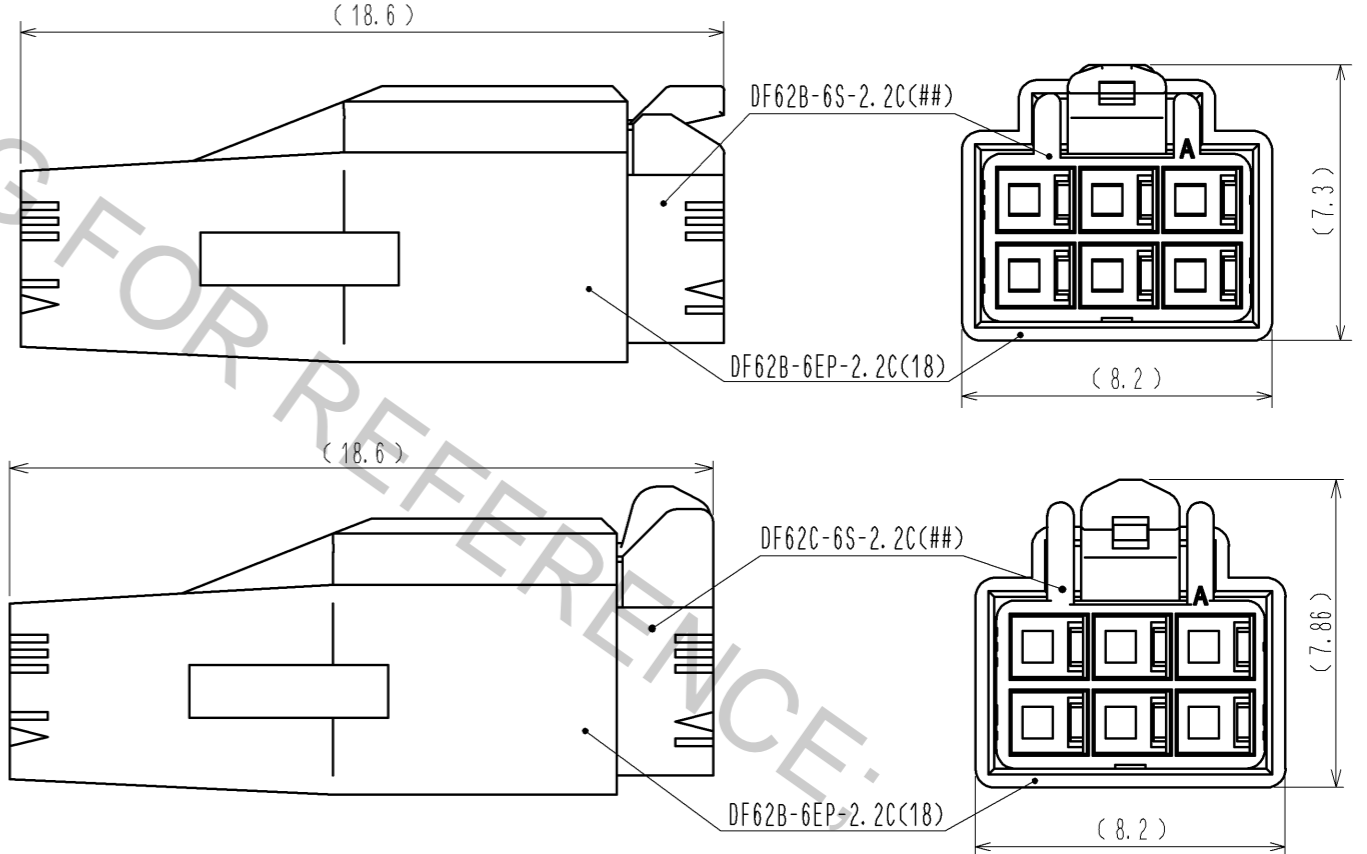

- Note. 1 Markings at the indicated positions are contact No. marking. And shapes are shown in Figure-1.
 2. Per pack : 100 pieces.
 3. The dimensions in parenthesis are for reference.
 4. UL (File No. E52653), C-UL (File No. E52653) approved product.



NO.		MATERIAL		FINISH . REMARKS		1	PBT	UL94V-0 (RED)	
UNITS mm		SCALE 5 : 1		COUNT		DESCRIPTION OF REVISIONS		DESIGNED	CHECKED
HRS		HIROSE ELECTRIC CO., LTD.		APPROVED : KI. AKIYAMA		14.06.06		DRAWING NO. EDC3-351967-02	
				CHECKED : TS. FUKUSHIMA		14.06.06		PART NO. DF62B-6EP-2.2C(18)	
				DESIGNED : TS. KUMAZAWA		14.06.06		CODE NO. CL544-0562-6-18	
				DRAWN : TS. KUMAZAWA		14.06.06		DATE	