

COUNT	DESCRIPTION OF REVISIONS	BY	CHKD	DATE	COUNT	DESCRIPTION OF REVISIONS	BY	CHKD	DATE
1	RE-E-08442	M.K	A.f	02.02.20					

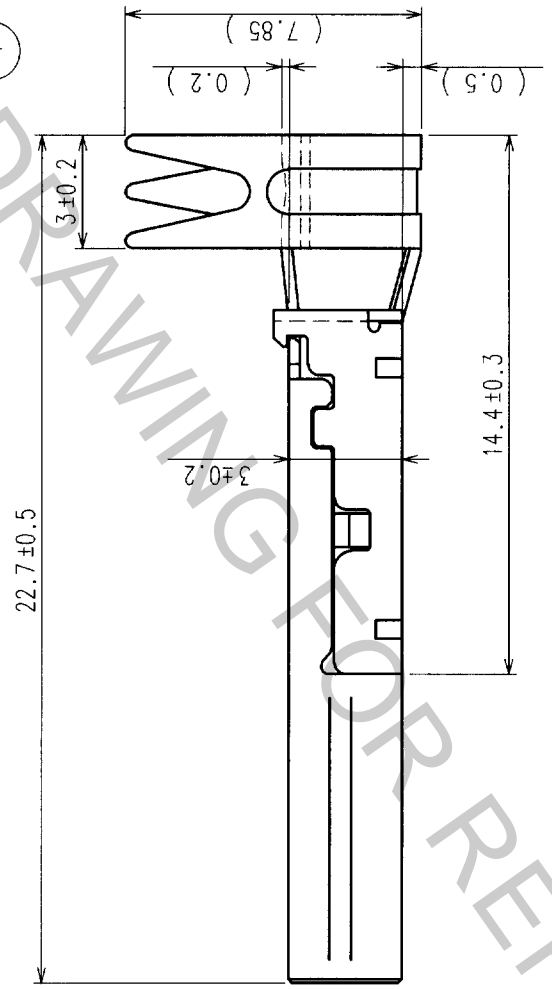

A-A

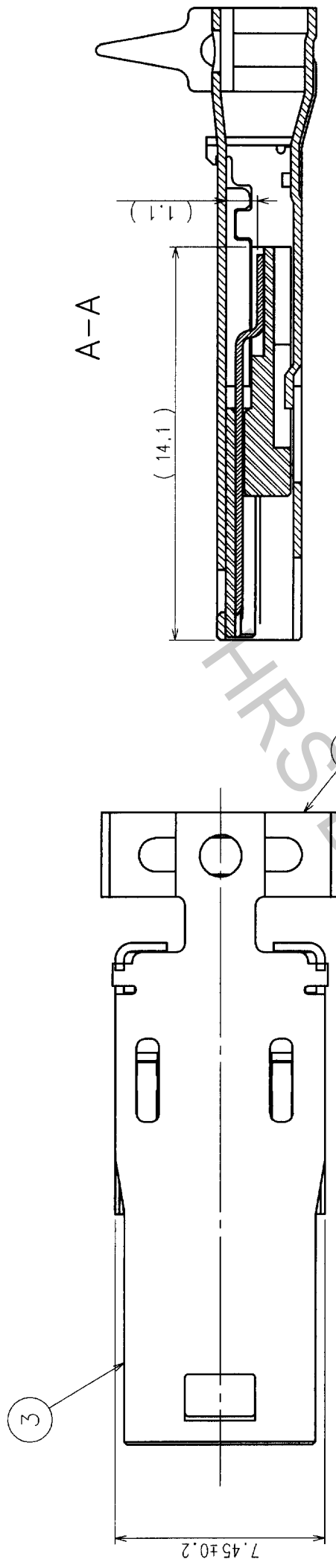
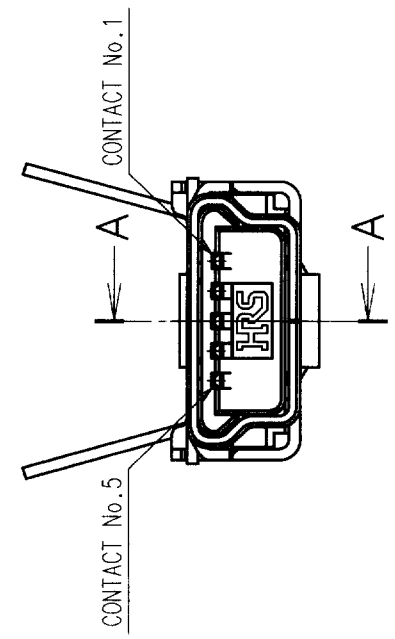
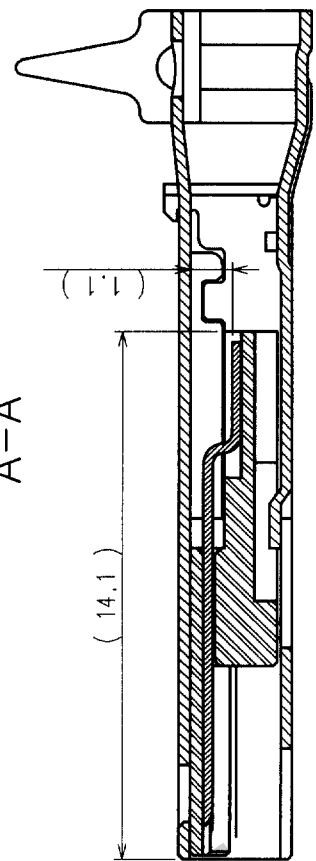

CONNECTOR UNIT

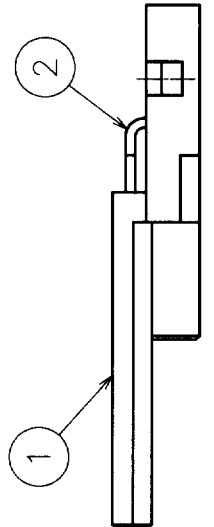
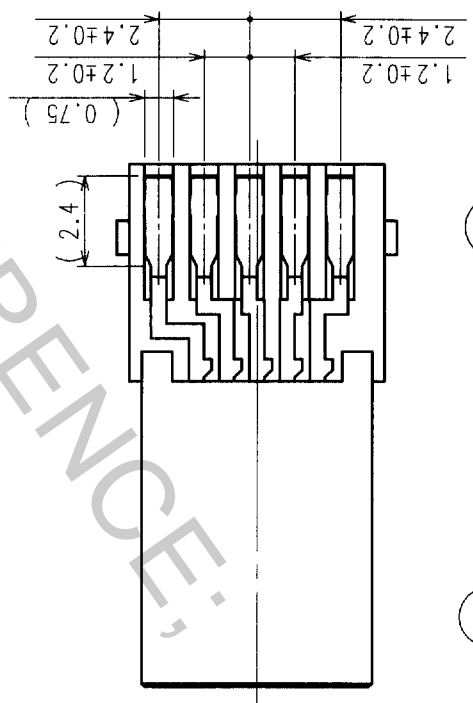

NOTES 1 INTERFACE DIMENSIONS CONFORM TO USB2.0 STANDARDS.(Mini-B)  
 2 COMPONENTS OF REF.NO. ③ AND ④ ARE APPENDED PRODUCTS.  
 ③ THE DIAMETER OF A CABLE SHOULD FOLLOW φ 4.1 TO φ 4.6 AS A GUIDE.  
 (IT CHANGES A LITTLE WITH HARDNESS OF A SHEATH ETC.)

NO.	COPPER ALLOY	SELECTED GOLD PLATING	4	STELL	TIN ALLOY PLATING	TIN ALLOY PLATING
1	PBT	BLACK UL94V-0	3	STELL	TIN ALLOY PLATING	TIN ALLOY PLATING
NO.	MATERIAL	FINISH, REMARKS	NO.	MATERIAL	FINISH, REMARKS	FINISH, REMARKS
CODE NO. (OLD)						
DRAWN		M.KENJO	DESIGNED	M.KENJO	CHECKED	A.SUZUKI
SCALE		5 : 1	DRAWN DATE	01.12.18	DESIGNED DATE	01.12.18
UNITS		mm	PART NO.		UX40A-MB-5P	
DRAWING NO.		EDC3-123440		APPROVED		S.KIKUTA
CODE NO.		CL240-0005-0		RELEASED		01.12.18

TO