

1 2 3 4 5

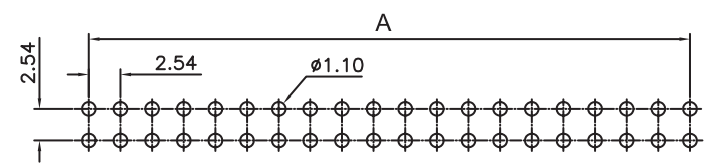

PCB LAYOUT - COMPONENT VIEW

61203921621: pin 20 removed

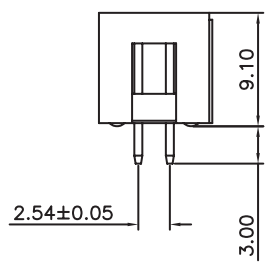
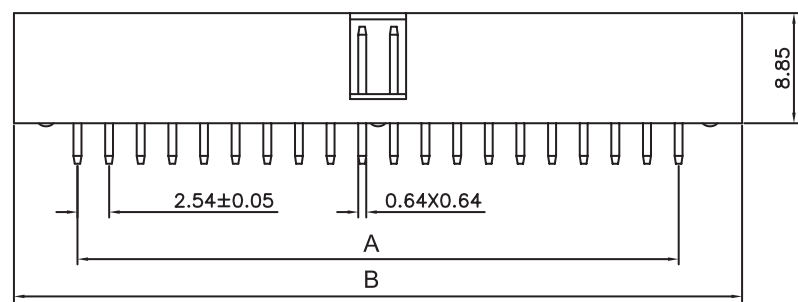
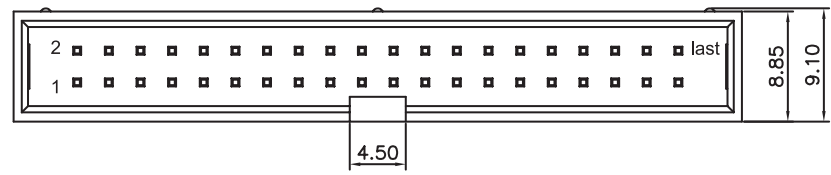
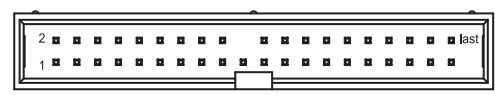

TECHNICAL CHARACTERISTICS

MATERIAL
 INSULATOR: PBT
 COLOR: BLACK
 CONTACT MATERIAL: COPPER ALLOY
 CONTACT TYPE: STAMPED
 CONTACT PLATING: GOLD
 QUALITY CLASS: 3 AS PER CECC 75 301-802
 PITCH: 2.54MM

ENVIRONMENTAL
 OPERATING TEMPERATURE: -40 UP TO 125°C
 FLAMABILITY RATING: UL94-V0
 COMPLIANCE: LEAD FREE AND ROHS

ELECTRICAL
 CURRENT RATING: 3A MAX
 WORKING VOLTAGE: 250V AC
 INSULATOR RESISTANCE: >1000 MOHM
 DIELECTRIC WITHSTANDING VOLTAGE: 500V AC/MN
 CONTACT RESISTANCE: 20 mOHM MAX

STANDARD
 CERTIFIED: E323964 / MODEL NUMBER 612-216

SOLDERING
 WAVE PROCESS ONLY

PACKAGING
 TRAY

DIMENSION
 A = 2.54 x (NB. PIN / 2 - 1)
 B = 2.54 x (NB. PIN / 2) + 7.66

NOTES:
 No. Of Positions 50-64 With 3 Keys
 All Oher Pin With 1 Key

RoHS Compliant				PROJECTION: 	GENERAL TOLERANCE .X = +/- 0.2 .XX = +/- 0.15	 WÜRTH ELEKTRONIK	DESCRIPTION: 2.54MM MALE BOX HEADER WERI PART NO: 612 0xx 216 21	SIZE A4
G	30-JUL-10	39PIN DRAWING	JC					
F	13-JUL-10	PACKAGING	JC					
E	16-NOV-09	STANDARD	JP					
D	27-NOV-07	MODIFICATIONS	EC					
C	19-DEC-06	DRAW	EC	APPROVAL: RJ	UNIT: MM	DESCRIPTION: 2.54MM MALE BOX HEADER		
B	21-JUN-04	LEAD FREE	JP		SCALE:	WERI PART NO: 612 0xx 216 21		
A	09-MAR-99	PDF	JP		SHEET: 1/2			
REV	DATE	FILE	BY		DRAW: PEARL			

1

2

3

4

5

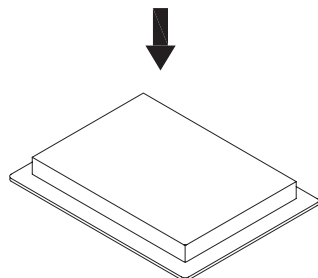
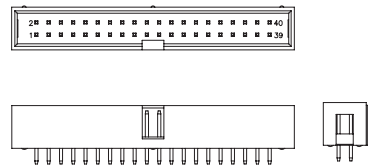

TRAY

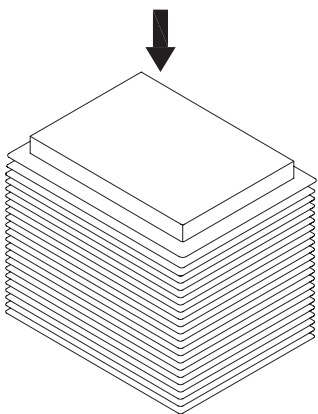

25TRAYS

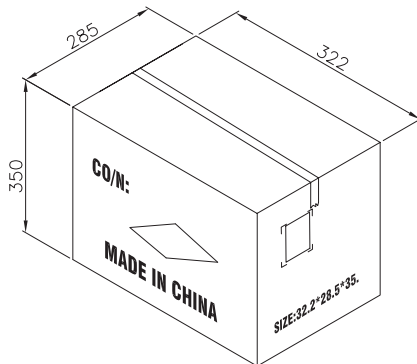
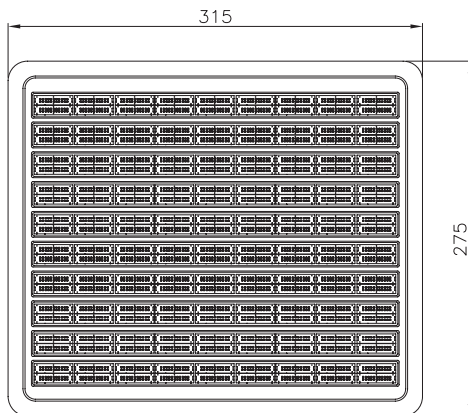

CARTON

Note:

1.Dimension:

Tray Size:315(L)x275(W)x15.4(H) (mm)

Carton Size:322(L)x285(W)x350(H) (mm)

2.Quantity:

Circuits	Pcs/Tray	Trays/Carton	Q'TY
06	360	25	9000
08	300	25	7500
10	260	25	6500
12	240	25	6000
14	200	25	5000
16	180	25	4500
20	160	25	4000
24	140	25	3500
26	120	25	3000
30	120	25	3000
34	100	25	2500
40	80	25	2000
50	60	25	1500
60	60	25	1500
64	60	25	1500

A

B

C

RoHS Compliant			
G			
F			
E			
D			
C			
B			
A			
REV	DATE	FILE	BY

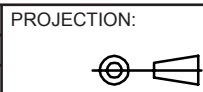

APPROVAL: RJ

GENERAL TOLERANCE

.X = +/- 0.2

.XX = +/- 0.15



DESCRIPTION: 2.54MM MALE BOX HEADER

WERI PART NO: 612 0xx 216 21

SIZE
A4

D