

Dimensions: [mm]

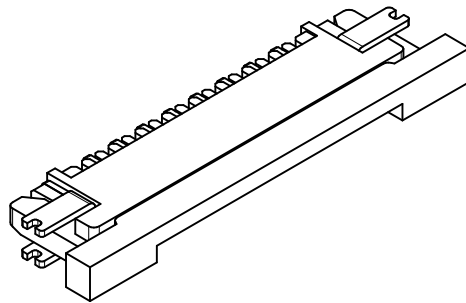

Recommended Hole Pattern: [mm]

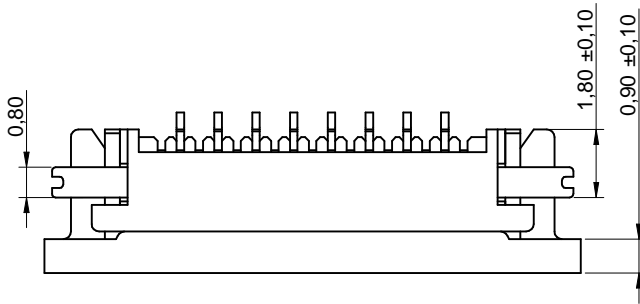
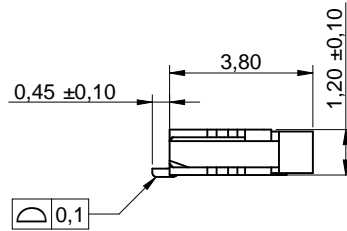
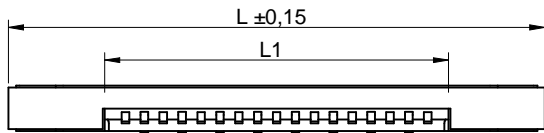
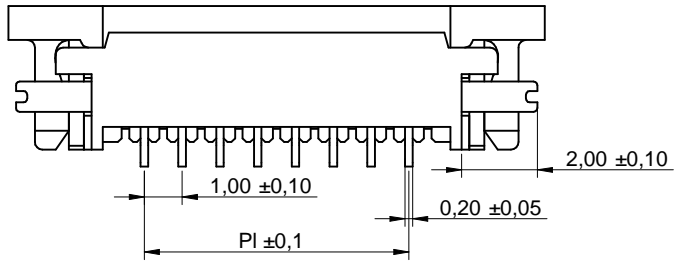
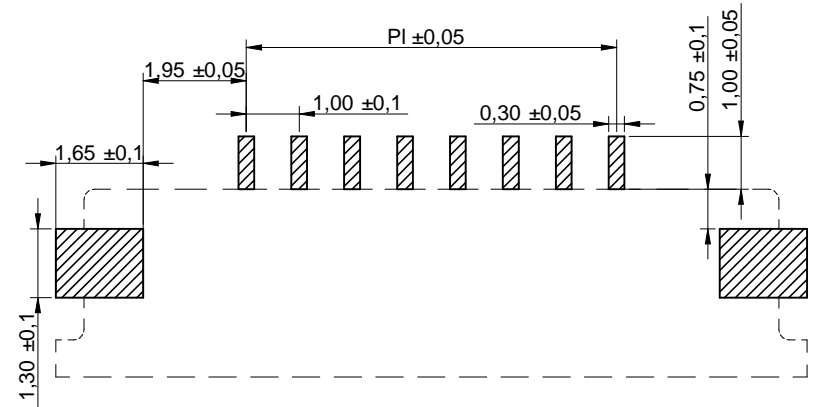

Article Properties:

Properties		Value	Unit
Pins		15	
Pin to Pin (Middle)	P_1	14	mm
Length	L	21.2	mm
Length	L_1	16.1	mm

Würth Elektronik eiSos GmbH & Co. KG
EMC & Inductive Solutions

Max-Eyth-Str. 1
74638 Waldenburg
Germany
Tel. +49 (0) 79 42 945 - 0

www.we-online.com
eiSos@we-online.com



CREATED ATo	CHECKED GMO	GENERAL TOLERANCE DIN ISO 2768-1m	PROJECTION METHOD
DESCRIPTION WR-FPC 1.00mm SMT Horizontal Bottom Contact - Low Profile		ORDER CODE 686 115 183 522	
REVISION 001.000	STATUS Valid	DATE 2016-08-15	BUSINESS UNIT eiCan
		PAGE 1/4	

Article Properties:

Pins	P ₁	L	L ₁	Order Code
4	3 mm	10.2 mm	5.1 mm	686 104 183 522
6	5 mm	12.2 mm	7.1 mm	686 106 183 522
8	7 mm	14.2 mm	9.1 mm	686 108 183 522
10	9 mm	16.2 mm	11.1 mm	686 110 183 522
14	13 mm	20.2 mm	15.1 mm	686 114 183 522
15	14 mm	21.2 mm	16.1 mm	686 115 183 522
16	15 mm	22.2 mm	17.1 mm	686 116 183 522
18	17 mm	24.2 mm	19.1 mm	686 118 183 522
24	23 mm	30.2 mm	25.1 mm	686 124 183 522

Kind Properties:

Properties	Value	Unit
Standard Polarities	04;06;08;10;14;15;16;18;24	
Pitch	1	mm
Quality Class	20 Mating cycles	

Material Properties:

Insulator Material	LCP
Insulator Color	Ivory
Insulator Flammability Rating	UL94-V0
Contact Material	Phosphor Bronze
Contact Plating	120 (μ) Tin over 50 (μ) Nickel
Contact Type	Stamped
Actuator Material	PA 6T
Actuator Color	Black
Actuator Flammability Rating	UL94-V0

General Information:

Operating Temperature	-25 °C up to +85 °C
Compliance	RoHS

Electrical Properties:

Properties	Test conditions		Value	Unit
Rated Current		I _R	0.8	A
Working Voltage			50	V (AC)
Withstanding Voltage	1 min		250	V (AC)
Contact Resistance		R	30	mΩ
Insulation Resistance		R _{ISO}	100	MΩ

Packaging Properties:

Packaging	Tape and Reel
-----------	---------------

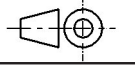
<p>Würth Elektronik eiSos GmbH & Co. KG EMC & Inductive Solutions</p> <p>Max-Eyth-Str. 1 74638 Waldenburg Germany Tel. +49 (0) 79 42 945 - 0</p> <p>www.we-online.com eiSos@we-online.com</p> 	CREATED Ato	CHECKED GMo	GENERAL TOLERANCE DIN ISO 2768-1m	PROJECTION METHOD 	
	<p>DESCRIPTION</p> <p>WR-FPC 1.00mm SMT Horizontal Bottom Contact - Low Profile</p>			<p>ORDER CODE</p> <p>686 115 183 522</p>	
	REVISION 001.000	STATUS Valid	DATE 2016-08-15	BUSINESS UNIT eiCan	PAGE 2/4

Classification Reflow Profile for SMT components:



Classification Reflow Soldering Profile:

Profile Feature		Value
Preheat Temperature Min ¹⁾	$T_{s \min}$	150 °C
Preheat Temperature Max	$T_{s \max}$	200 °C
Preheat Time t_s from $T_{s \min}$ to $T_{s \max}$	t_s	60 - 120 seconds
Ramp-up Rate (T_L to T_p)		3 °C/ second max.
Liquidous Temperature	T_L	217 °C
Time t_L maintained above T_L	t_L	60 - 150 seconds
Peak package body temperature	T_p	see table
Time within 5°C of actual peak tempereure	t_p	20 - 30 seconds
Ramp-down Rate (T_L to T_p)		6 °C/ second max.
Time 25°C to peak temperature		8 minutes max.

¹⁾ refer to IPC/JEDEC J-STD-020D
refer to IPC/ JEDEC J-STD-020E

Package Classification Reflow Temperature:

Properties	Volume mm ³ <350	Volume mm ³ 350-2000	Volume mm ³ >2000
PB-Free Assembly Package Thickness < 1.6 mm ¹⁾	260 °C	260 °C	260 °C
PB-Free Assembly Package Thickness 1.6 mm - 2.5 mm	260 °C	250 °C	245 °C
PB-Free Assembly Package Thickness ≥ 2.5 mm	250 °C	245 °C	245 °C

¹⁾ refer to IPC/JEDEC J-STD-020D
refer to IPC/ JEDEC J-STD-020E

Würth Elektronik eiSos GmbH & Co. KG
EMC & Inductive Solutions

Max-Eyth-Str. 1
74638 Waldenburg
Germany
Tel. +49 (0) 79 42 945 - 0

www.we-online.com
eiSos@we-online.com



CREATED Ato	CHECKED GMo	GENERAL TOLERANCE DIN ISO 2768-1m	PROJECTION METHOD
DESCRIPTION WR-FPC 1.00mm SMT Horizontal Bottom Contact - Low Profile		ORDER CODE 686 115 183 522	
REVISION 001.000	STATUS Valid	DATE 2016-08-15	BUSINESS UNIT eiCan
		PAGE 3/4	

Important Notes

The following conditions apply to all goods within the product range of Würth Elektronik eiSos GmbH & Co. KG:

1. General Customer Responsibility

Some goods within the product range of Würth Elektronik eiSos GmbH & Co. KG contain statements regarding general suitability for certain application areas. These statements about suitability are based on our knowledge and experience of typical requirements concerning the areas, serve as general guidance and cannot be estimated as binding statements about the suitability for a customer application. The responsibility for the applicability and use in a particular customer design is always solely within the authority of the customer. Due to this fact it is up to the customer to evaluate, where appropriate to investigate and decide whether the device with the specific product characteristics described in the product specification is valid and suitable for the respective customer application or not.

2. Customer Responsibility related to Specific, in particular Safety-Relevant Applications

It has to be clearly pointed out that the possibility of a malfunction of electronic components or failure before the end of the usual lifetime cannot be completely eliminated in the current state of the art, even if the products are operated within the range of the specifications. In certain customer applications requiring a very high level of safety and especially in customer applications in which the malfunction or failure of an electronic component could endanger human life or health it must be ensured by most advanced technological aid of suitable design of the customer application that no injury or damage is caused to third parties in the event of malfunction or failure of an electronic component. Therefore, customer is cautioned to verify that data sheets are current before placing orders. The current data sheets can be downloaded at www.we-online.com.

3. Best Care and Attention

Any product-specific notes, cautions and warnings must be strictly observed. Any disregard will result in the loss of warranty.

4. Customer Support for Product Specifications

Some products within the product range may contain substances which are subject to restrictions in certain jurisdictions in order to serve specific technical requirements. Necessary information is available on request. In this case the field sales engineer or the internal sales person in charge should be contacted who will be happy to support in this matter.

5. Product R&D

Due to constant product improvement product specifications may change from time to time. As a standard reporting procedure of the Product Change Notification (PCN) according to the JEDEC-Standard inform about minor and major changes. In case of further queries regarding the PCN, the field sales engineer or the internal sales person in charge should be contacted. The basic responsibility of the customer as per Section 1 and 2 remains unaffected.

6. Product Life Cycle

Due to technical progress and economical evaluation we also reserve the right to discontinue production and delivery of products. As a standard reporting procedure of the Product Termination Notification (PTN) according to the JEDEC-Standard we will inform at an early stage about inevitable product discontinuance. According to this we cannot guarantee that all products within our product range will always be available. Therefore it needs to be verified with the field sales engineer or the internal sales person in charge about the current product availability expectancy before or when the product for application design-in disposal is considered. The approach named above does not apply in the case of individual agreements deviating from the foregoing for customer-specific products.

7. Property Rights

All the rights for contractual products produced by Würth Elektronik eiSos GmbH & Co. KG on the basis of ideas, development contracts as well as models or templates that are subject to copyright, patent or commercial protection supplied to the customer will remain with Würth Elektronik eiSos GmbH & Co. KG. Würth Elektronik eiSos GmbH & Co. KG does not warrant or represent that any license, either expressed or implied, is granted under any patent right, copyright, mask work right, or other intellectual property right relating to any combination, application, or process in which Würth Elektronik eiSos GmbH & Co. KG components or services are used.

8. General Terms and Conditions

Unless otherwise agreed in individual contracts, all orders are subject to the current version of the "General Terms and Conditions of Würth Elektronik eiSos Group", last version available at www.we-online.com.

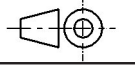
Würth Elektronik eiSos GmbH & Co. KG EMC & Inductive Solutions Max-Eyth-Str. 1 74638 Waldenburg Germany Tel. +49 (0) 79 42 945 - 0 www.we-online.com eiSos@we-online.com 	CREATED ATo	CHECKED GMo	GENERAL TOLERANCE DIN ISO 2768-1m	PROJECTION METHOD 	
	DESCRIPTION WR-FPC 1.00mm SMT Horizontal Bottom Contact - Low Profile			ORDER CODE 686 115 183 522	
	REVISION 001.000	STATUS Valid	DATE 2016-08-15	BUSINESS UNIT eiCan	PAGE 4/4