

Dimensions: [mm]

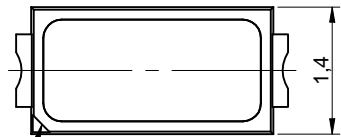

Polarity Mark Anode

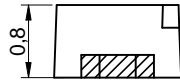
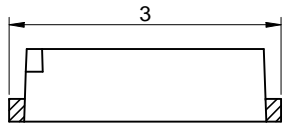
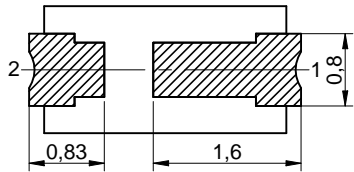
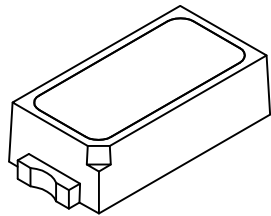

Scale - 12:1

Recommended Land Pattern: [mm]

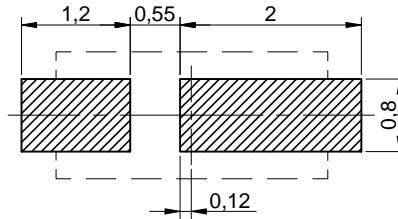

Scale - 12:1

Schematic:

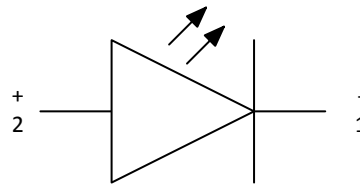

Absolute Maximum Ratings (Ambient Temperature 25°C):

Properties	Test conditions		Value	Unit
Peak Forward Current	duty/ 10 @ 1 kHz	$I_{F\ PEAK}$	40	mA
Continuous Forward Current		I_F	30	mA
Reverse Voltage		V_{REV}	5	V
ESD Threshold/ Human Body Model		$V_{ESD\ HEM}$	2000	V
Absolute Thermal Resistance Junction to Solder Point		$R_{\theta JS}$	38	K/W
Junction Temperature		T_J	130	°C

Optical Properties:

Chip Technology	InGaN
Emitting Color	Cool White
Lens Type	Top LED

General Information:

Operating Temperature	-40 °C up to +85 °C	
Storage Temperature (in original packaging)	-40 °C up to +85 °C; 60% RH max.	
Moisture Sensitive Level	MSL	3

Würth Elektronik eiSos GmbH & Co. KG
EMC & Inductive Solutions

Max-Eyth-Str. 1
74638 Waldenburg
Germany
Tel. +49 (0) 79 42 945 - 0

www.we-online.com
eiSos@we-online.com



CREATED
KaS

CHECKED
ZAn

GENERAL TOLERANCE
DIN ISO 2768-1m

PROJECTION METHOD

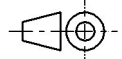

DESCRIPTION

**WL-SWTP SMD White Top View
PLCC LED**

ORDER CODE

158301260

SIZE
3014

REVISION
004.000

STATUS
Valid

DATE
2016-07-21

BUSINESS UNIT
eiPal

PAGE
1/9

Electrical & Optical Properties:

Properties	Test conditions		Value			Unit
			min.	typ.	max.	
Chromaticity Coordinate X	20 mA	c_x		0.3233		
Chromaticity Coordinate Y	20 mA	c_y		0.3327		
Luminous Flux	20 mA	Φ_V	6.5	8		lm
Forward Voltage	20 mA	V_F		3	3.5	V
Correlated Color Temperature	20 mA	CCT		6000		K
Reverse Current	5 V	I_{REV}			5	μA
Color Rendering Index	20 mA	CRI	85	90		
Viewing Angle	20 mA	$2\theta_{50\%}$		120		$^\circ$

Viewing Angle:

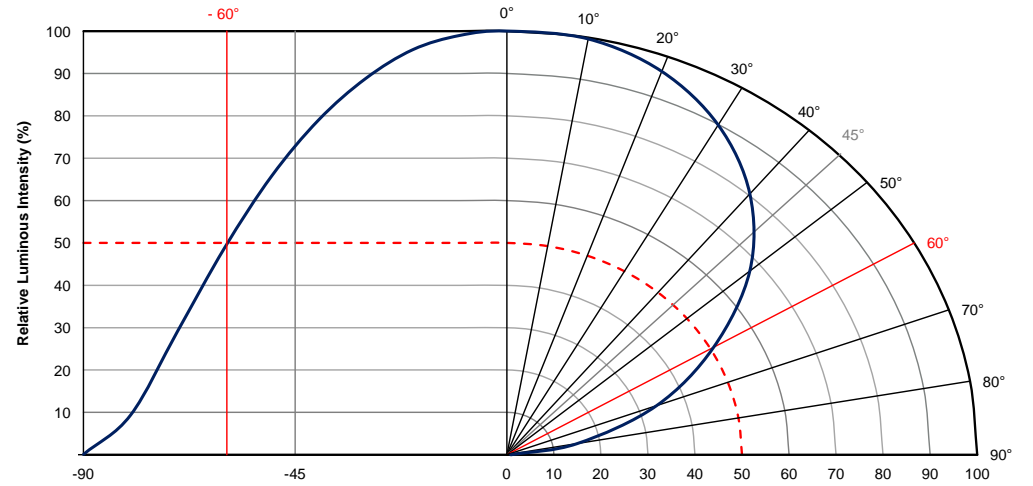

Würth Elektronik eiSos GmbH & Co. KG EMC & Inductive Solutions Max-Eyth-Str. 1 74638 Waldenburg Germany Tel. +49 (0) 79 42 945 - 0 www.we-online.com eiSos@we-online.com		CREATED KaS	CHECKED ZAn	GENERAL TOLERANCE DIN ISO 2768-1m	PROJECTION METHOD 	
DESCRIPTION WL-SWTP SMD White Top View PLCC LED			ORDER CODE 158301260			
SIZE 3014	REVISION 004.000	STATUS Valid	DATE 2016-07-21	BUSINESS UNIT eiPal	PAGE 2/9	



Spectral:

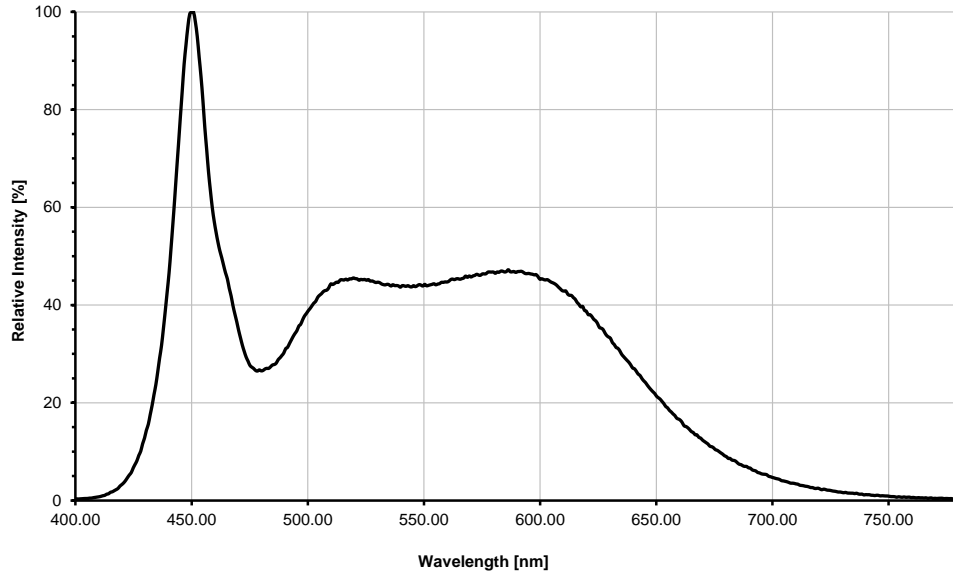

Forward Current vs. Forward Voltage:

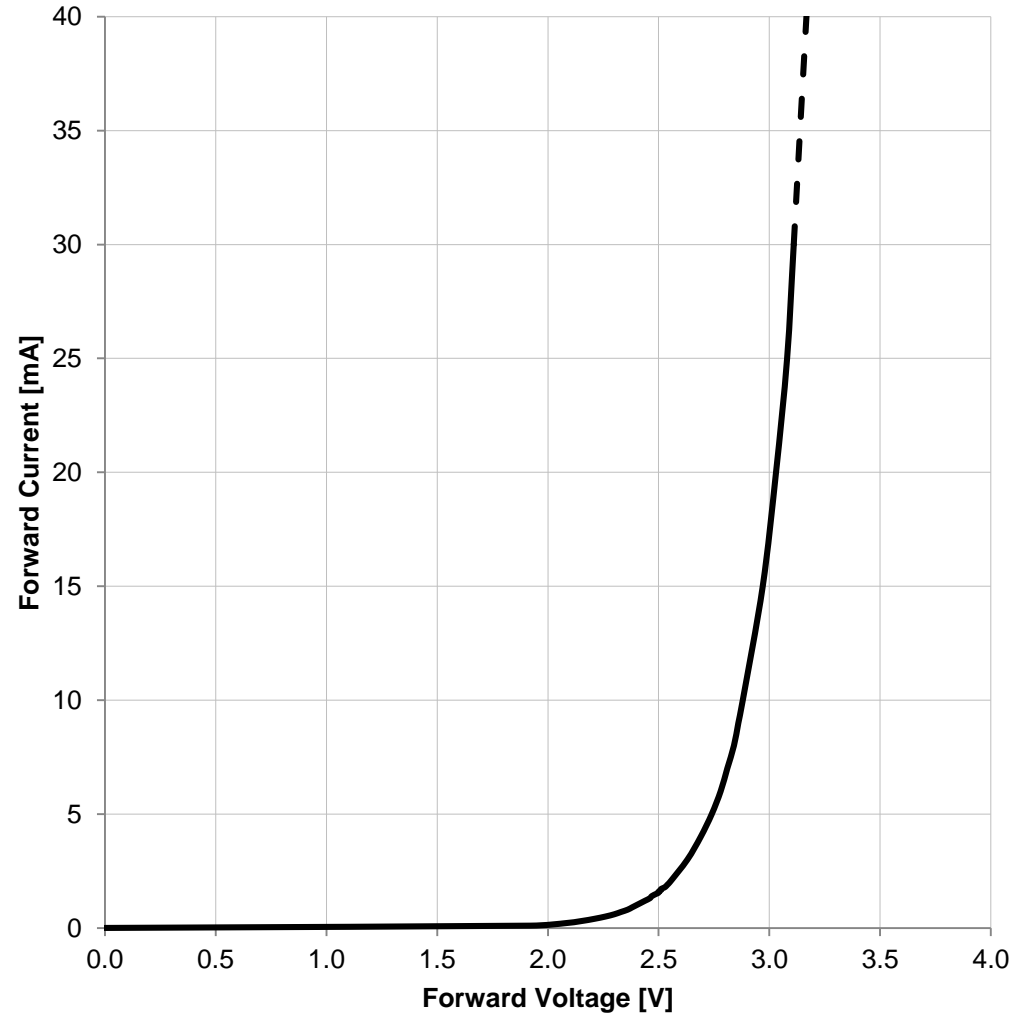



Würth Elektronik eiSos GmbH & Co. KG
EMC & Inductive Solutions

Max-Eyth-Str. 1
74638 Waldenburg
Germany
Tel. +49 (0) 79 42 945 - 0

www.we-online.com
eiSos@we-online.com

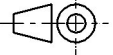

CREATED KaS	CHECKED ZAn	GENERAL TOLERANCE DIN ISO 2768-1m	PROJECTION METHOD 	
DESCRIPTION WL-SWTP SMD White Top View PLCC LED			ORDER CODE 158301260	
SIZE 3014	REVISION 004.000	STATUS Valid	DATE 2016-07-21	BUSINESS UNIT eiPal
			PAGE 3/9	

Luminous Intensity vs. Forward Current:

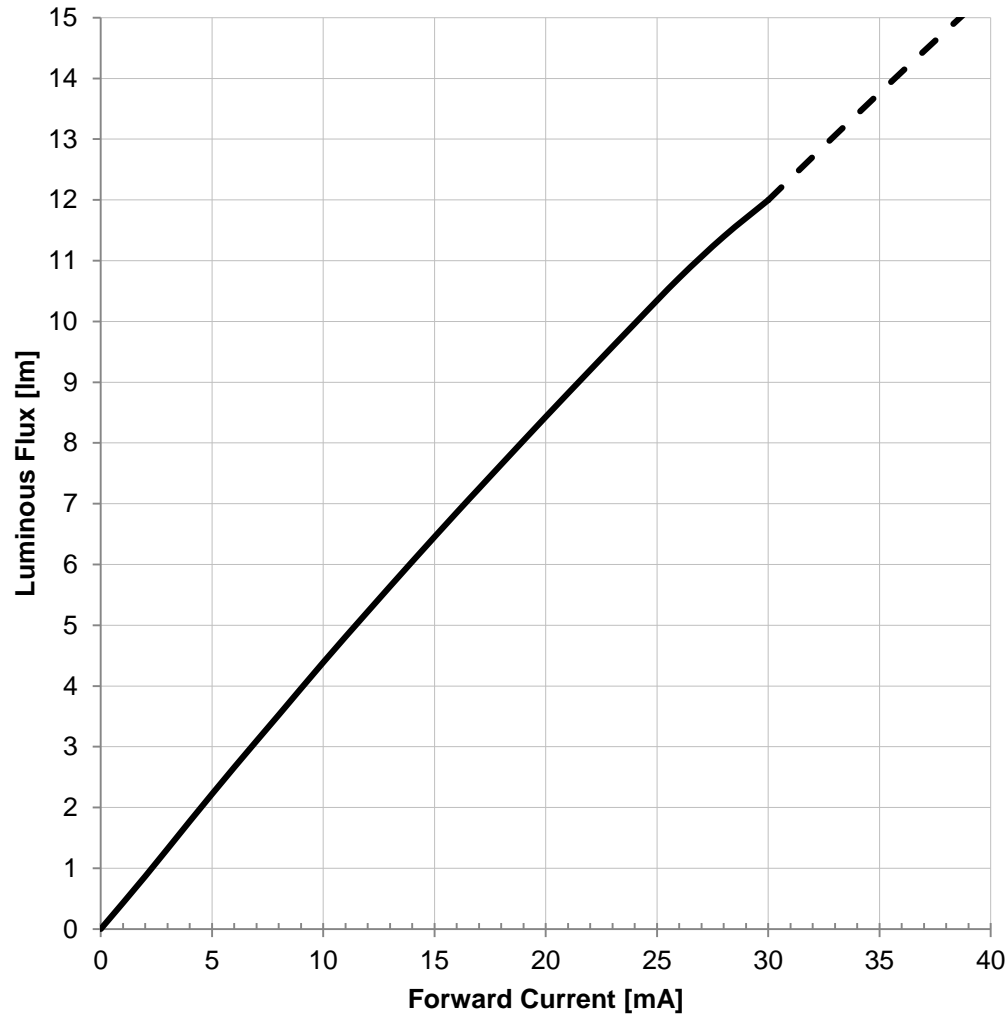

Derating Curve:

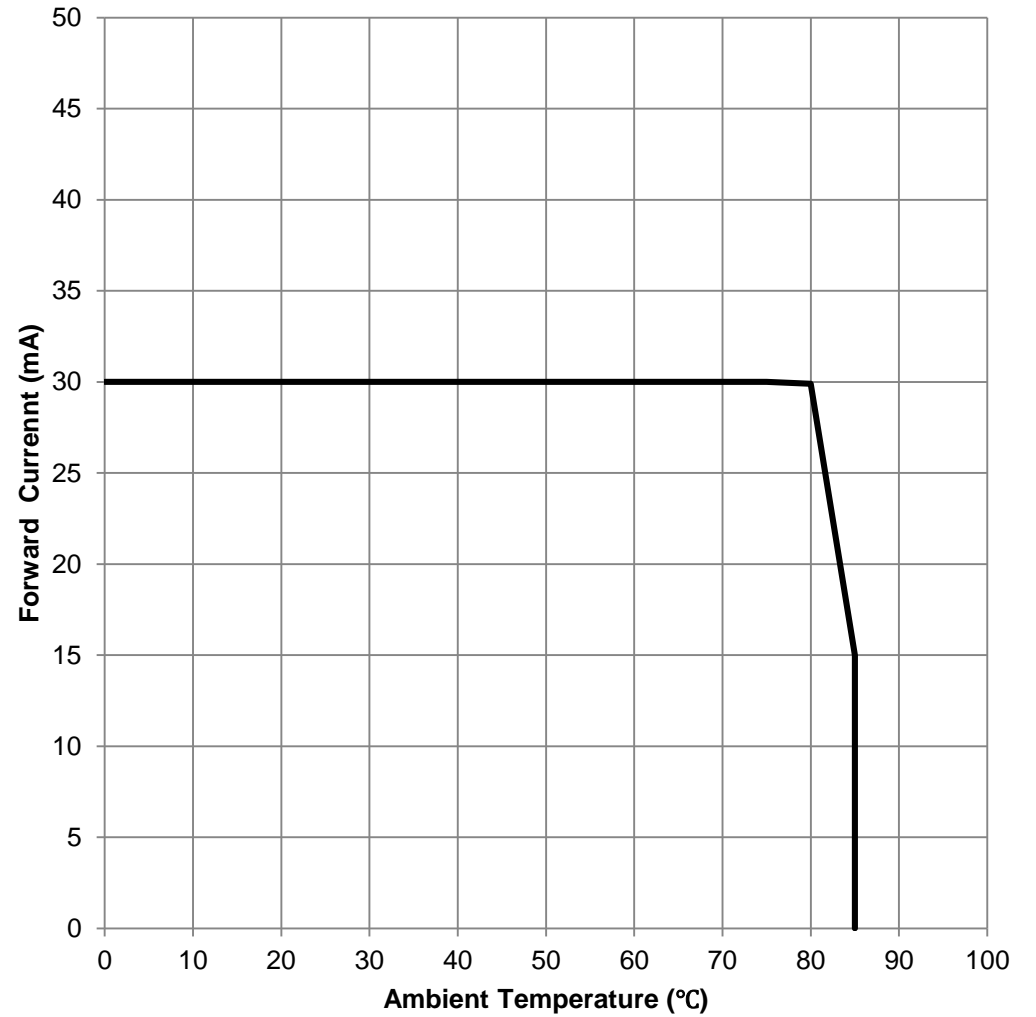

Würth Elektronik eiSos GmbH & Co. KG
EMC & Inductive Solutions

Max-Eyth-Str. 1
74638 Waldenburg
Germany
Tel. +49 (0) 79 42 945 - 0

www.we-online.com
eiSos@we-online.com



CREATED KaS	CHECKED ZAn	GENERAL TOLERANCE DIN ISO 2768-1m	PROJECTION METHOD 	
DESCRIPTION WL-SWTP SMD White Top View PLCC LED			ORDER CODE 158301260	
SIZE 3014	REVISION 004.000	STATUS Valid	DATE 2016-07-21	BUSINESS UNIT eiPal
			DATE	PAGE 4/9

Chromaticity diagram:

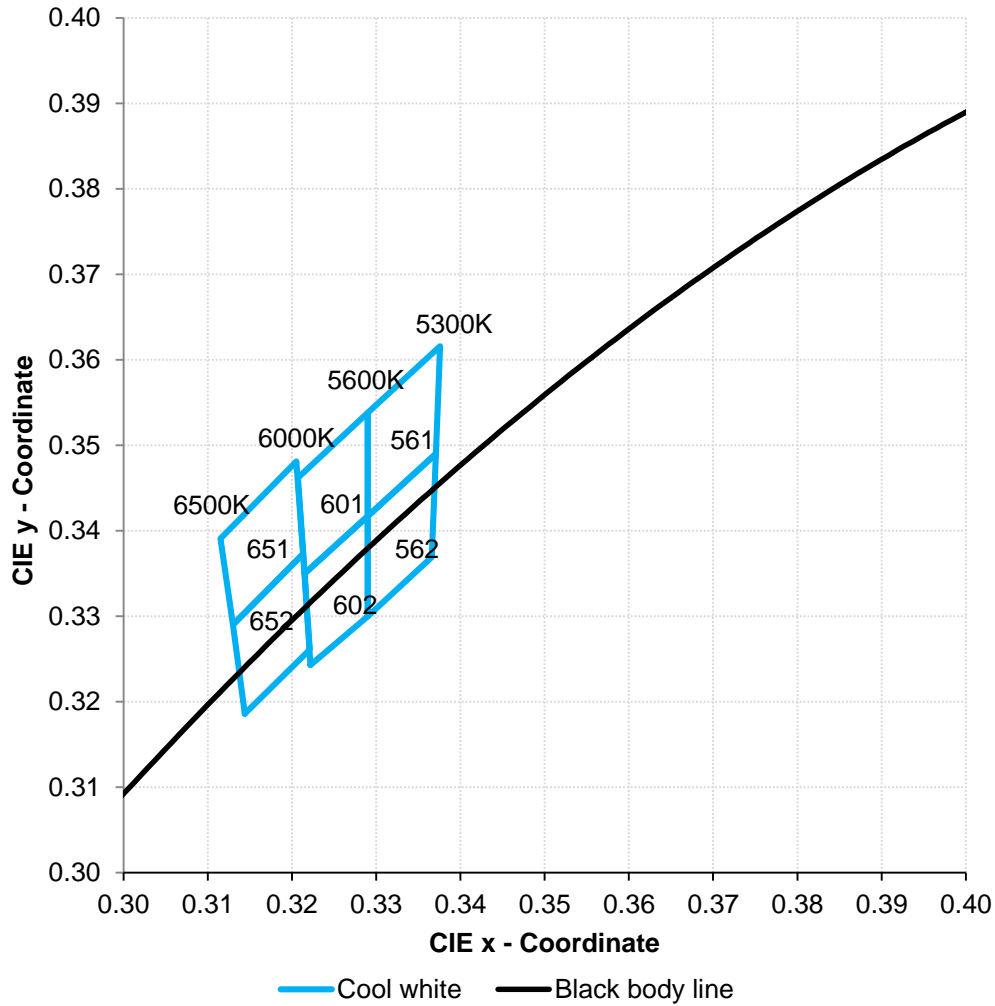

5300K to 5600K	Cx	Cy	5600K to 6000K	Cx	Cy	6000K to 6500K	Cx	Cy
561	0.3290	0.3417	601	0.3215	0.3350	651	0.3130	0.3290
	0.3290	0.3538		0.3207	0.3462		0.3115	0.3391
	0.3376	0.3616		0.3290	0.3538		0.3205	0.3481
	0.3371	0.3490		0.3290	0.3417		0.3213	0.3373
	0.3290	0.3417		0.3215	0.3350		0.3130	0.3290
562	0.3290	0.3300	602	0.3222	0.3243	652	0.3144	0.3186
	0.3290	0.3417		0.3215	0.3350		0.3130	0.3290
	0.3371	0.3490		0.3290	0.3417		0.3213	0.3373
	0.3366	0.3369		0.3290	0.3300		0.3221	0.3261
	0.3290	0.3300		0.3222	0.3243		0.3144	0.3186

Würth Elektronik eiSos GmbH & Co. KG EMC & Inductive Solutions Max-Eyth-Str. 1 74638 Waldenburg Germany Tel. +49 (0) 79 42 945 - 0 www.we-online.com eiSos@we-online.com	CREATED KaS	CHECKED ZAn	GENERAL TOLERANCE DIN ISO 2768-1m	PROJECTION METHOD 	
	DESCRIPTION WL-SWTP SMD White Top View PLCC LED			ORDER CODE 158301260	
	SIZE 3014	REVISION 004.000	STATUS Valid	DATE 2016-07-21	BUSINESS UNIT eiPal
					PAGE 5/9

This electronic component has been designed and developed for usage in general electronic equipment only. This product is not authorized for use in equipment where a higher safety standard and reliability standard is especially required or where a failure of the product is reasonably expected to cause severe personal injury or death, unless the parties have executed an agreement specifically governing such use. Moreover Würth Elektronik eiSos GmbH & Co KG products are neither designed nor intended for use in areas such as military, aerospace, aviation, nuclear control, submarine, transportation (automotive control, train control, ship control), transportation signal, disaster prevention, medical, public information network etc. Würth Elektronik eiSos GmbH & Co KG must be informed about the intent of such usage before the design-in stage. In addition, sufficient reliability evaluation checks for safety must be performed on every electronic component which is used in electrical circuits that require high safety and reliability functions or performance.

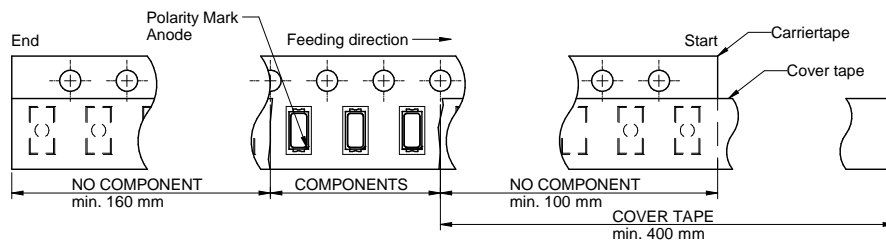
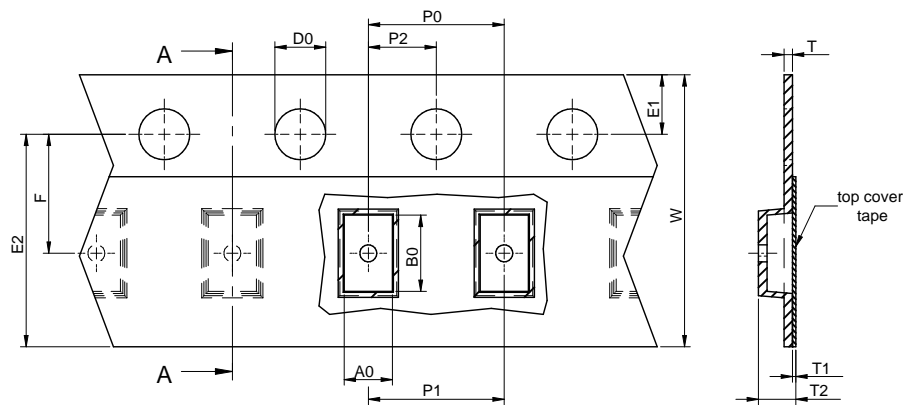

Packaging is referred to the international standard IEC 60286-3:2007

	A0	B0	W	P1	T	T1	T2	D0	E1	E2	F	P0	P2	Tape Type	VPE / Packaging Unit
tolerance	typ.	typ.	+0.3/-0.1	±0.1	±0.1	max.	typ.	+0.1/-0.0	±0.1	min.	±0.05	±0.1	±0.05	Polystyrene	2000
size	3014	3.2	1.6	8	4	0.25	0.1	1.5	1.75	6.25	3.5	4	2		

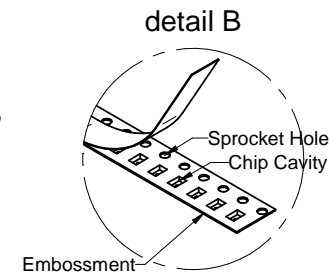
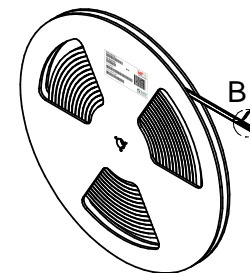
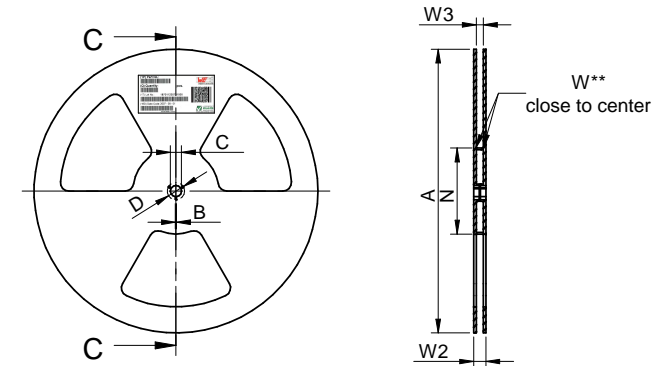

	A	B	C	D	N	W1	W2	W3	W3	
tolerance	±0.2	min.	±0.8	min.	min.	+1.5	max.	min.	max.	
Tape width	8 mm	178	1.5	13	20.2	50	8.4	14.4	7.9	10.9

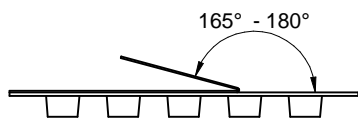

Tape width	8 mm	Pull-of force	0,1 N - 1,0 N
------------	------	---------------	---------------

Würth Elektronik eiSos GmbH & Co. KG
EMC & Inductive Solutions

Max-Eyth-Str. 1
74638 Waldenburg
Germany
Tel. +49 (0) 79 42 945 - 0

www.we-online.com
eiSos@we-online.com



CREATED KaS	CHECKED ZAn	GENERAL TOLERANCE DIN ISO 2768-1m	PROJECTION METHOD 	
DESCRIPTION WL-SWTP SMD White Top View PLCC LED			ORDER CODE 158301260	
SIZE 3014	REVISION 004.000	STATUS Valid	DATE 2016-07-21	BUSINESS UNIT eiPal
			PAGE 6/9	

Classification Reflow Profile for SMT components:

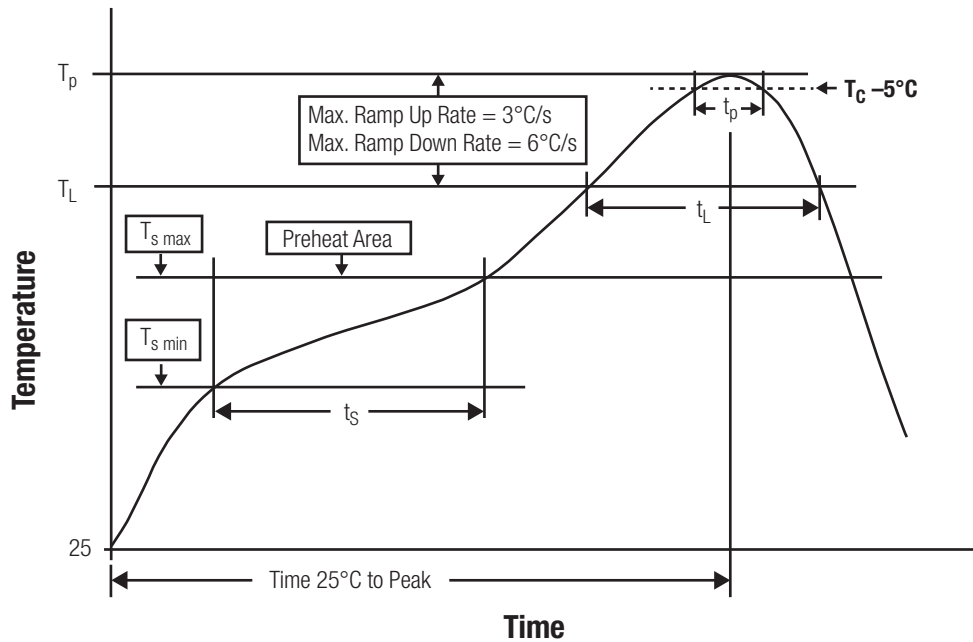

Classification Reflow Soldering Profile:

Profile Feature		Value
Preheat Temperature Min	$T_{s\ min}$	150 °C
Preheat Temperature Max	$T_{s\ max}$	200 °C
Preheat Time t_s from $T_{s\ min}$ to $T_{s\ max}$	t_s	60 - 120 seconds
Ramp-up Rate (T_L to T_p)		3 °C/ second max.
Liquidous Temperature	T_L	217 °C
Time t_L maintained above T_L	t_L	max. 60 seconds
Peak package body temperature	T_p	see table
Time within 5°C of actual peak temperature	t_p	max. 10 seconds
Ramp-down Rate (T_L to T_p)		6 °C/ second max.
Time 25°C to peak temperature		max. 220 seconds
Applied cycles		2 cycles max.

refer to IPC/ JEDEC J-STD-020E

Package Classification Reflow Temperature:

Properties	Volume mm³ <350	Volume mm³ 350-2000	Volume mm³ >2000
PB-Free Assembly Package Thickness < 1.6 mm	260 °C	260 °C	260 °C
PB-Free Assembly Package Thickness 1.6 mm - 2.5 mm	260 °C	250 °C	245 °C
PB-Free Assembly Package Thickness ≥ 2.5 mm	250 °C	245 °C	245 °C

refer to IPC/ JEDEC J-STD-020E

Würth Elektronik eiSos GmbH & Co. KG
EMC & Inductive Solutions

Max-Eyth-Str. 1
74638 Waldenburg
Germany
Tel. +49 (0) 79 42 945 - 0

www.we-online.com
eiSos@we-online.com



CREATED KaS	CHECKED ZAn	GENERAL TOLERANCE DIN ISO 2768-1m	PROJECTION METHOD 	
DESCRIPTION WL-SWTP SMD White Top View PLCC LED			ORDER CODE 158301260	
SIZE 3014	REVISION 004.000	STATUS Valid	DATE 2016-07-21	BUSINESS UNIT eiPal
			PAGE 7/9	

Cautions and Warnings:

The following conditions apply to all goods within the product series of **WL-SWTP** of **Würth Elektronik eiSos GmbH & Co. KG**:

General:

All recommendations according to the general technical specifications of the data sheet have to be complied with.

The usage and operation of the product within ambient conditions, which probably alloy or harm the component surface, has to be avoided.

If the product is potted in customer applications, the potting material might shrink during and after hardening. The product is exposed to the pressure of the potting material with the effect that the LED body, pins or termination is possibly damaged by this pressure and so the electrical as well as the mechanical characteristics are endangered to be affected. After the potting material is cured, the LED body, pins or termination of the product have to be checked if any reduced electrical or mechanical functions or destructions have occurred.

The responsibility for the applicability of customer specific products and use in a particular customer design is always within the authority of the customer. All technical specifications for standard products do also apply to customer specific products.

Washing varnish agent that is used during the production to clean the customer application might damage or change the characteristics of the LED body, pins or termination. The washing varnish agent could have a negative effect on the long term function of the product.

Direct mechanical impact to the product shall be prevented as the material of the LED body, pins or termination could flake or in the worst case it could break.

The standard deliveries include values in the range and limitation as defined in the Electrical Optical Properties specified in the datasheet. On each reel, only one bin is sorted and taped. The bin is defined on intensity, chromaticity coordinate or wavelength and forward voltage. In order to ensure highest availability, the reel binning of standard deliveries can vary. A single bin cannot be ordered. Please contact us in advance, if you need a particular bin sorting before placing your order to clarify the lead time, MOQ and pricing.



Product specific:

Follow all instructions mentioned in the data sheet, especially:

- The soldering profile has to be complied with according to the technical reflow/ or wave soldering specification, otherwise this will void the warranty.
- All products shall be used before the end of the period of 12 months based on the product date code, if not a 100% solderability can't be ensured.
- Violation of the technical product specifications such as exceeding the absolute maximum ratings will void the warranty.

- It is also recommended to return the LEDs to the original moisture proof bag and reseal the moisture proof bag again.
- Certain LED surfaces consist of soft material. Pressure on the top surface has to be handled carefully to prevent negative influence to the function and reliability of the LEDs.
- ESD prevention methods need to be applied for manual handling and processing by machinery.
- Resistors for protection are obligatory.
- Luminaires in operation could harm human vision or skin on a photo-biological level, therefore direct light impact has to be avoided. All products are additionally certified as risk groups 0 to 2 according to DIN EN 62471:2008.

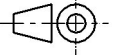
The general and product specific cautions comply with the state of the scientific and technical knowledge and are believed to be accurate and reliable; however, no responsibility is assumed for inaccuracies or incompleteness.

Würth Elektronik eiSos GmbH & Co. KG EMC & Inductive Solutions Max-Eyth-Str. 1 74638 Waldenburg Germany Tel. +49 (0) 79 42 945 - 0 www.we-online.com eiSos@we-online.com		CREATED KaS	CHECKED ZAn	GENERAL TOLERANCE DIN ISO 2768-1m	PROJECTION METHOD 	
DESCRIPTION WL-SWTP SMD White Top View PLCC LED			ORDER CODE 158301260			
SIZE 3014	REVISION 004.000	STATUS Valid	DATE 2016-07-21	BUSINESS UNIT eiPal	PAGE 8/9	

Important Notes

The following conditions apply to all goods within the product range of Würth Elektronik eiSos GmbH & Co. KG:

1. General Customer Responsibility

Some goods within the product range of Würth Elektronik eiSos GmbH & Co. KG contain statements regarding general suitability for certain application areas. These statements about suitability are based on our knowledge and experience of typical requirements concerning the areas, serve as general guidance and cannot be estimated as binding statements about the suitability for a customer application. The responsibility for the applicability and use in a particular customer design is always solely within the authority of the customer. Due to this fact it is up to the customer to evaluate, where appropriate to investigate and decide whether the device with the specific product characteristics described in the product specification is valid and suitable for the respective customer application or not.

2. Customer Responsibility related to Specific, in particular Safety-Relevant Applications

It has to be clearly pointed out that the possibility of a malfunction of electronic components or failure before the end of the usual lifetime cannot be completely eliminated in the current state of the art, even if the products are operated within the range of the specifications. In certain customer applications requiring a very high level of safety and especially in customer applications in which the malfunction or failure of an electronic component could endanger human life or health it must be ensured by most advanced technological aid of suitable design of the customer application that no injury or damage is caused to third parties in the event of malfunction or failure of an electronic component. Therefore, customer is cautioned to verify that data sheets are current before placing orders. The current data sheets can be downloaded at www.we-online.com.

3. Best Care and Attention

Any product-specific notes, cautions and warnings must be strictly observed. Any disregard will result in the loss of warranty.

4. Customer Support for Product Specifications

Some products within the product range may contain substances which are subject to restrictions in certain jurisdictions in order to serve specific technical requirements. Necessary information is available on request. In this case the field sales engineer or the internal sales person in charge should be contacted who will be happy to support in this matter.

5. Product R&D

Due to constant product improvement product specifications may change from time to time. As a standard reporting procedure of the Product Change Notification (PCN) according to the JEDEC-Standard inform about minor and major changes. In case of further queries regarding the PCN, the field sales engineer or the internal sales person in charge should be contacted. The basic responsibility of the customer as per Section 1 and 2 remains unaffected.

6. Product Life Cycle



Due to technical progress and economical evaluation we also reserve the right to discontinue production and delivery of products. As a standard reporting procedure of the Product Termination Notification (PTN) according to the JEDEC-Standard we will inform at an early stage about inevitable product discontinuance. According to this we cannot guarantee that all products within our product range will always be available. Therefore it needs to be verified with the field sales engineer or the internal sales person in charge about the current product availability expectancy before or when the product for application design-in disposal is considered. The approach named above does not apply in the case of individual agreements deviating from the foregoing for customer-specific products.

7. Property Rights

All the rights for contractual products produced by Würth Elektronik eiSos GmbH & Co. KG on the basis of ideas, development contracts as well as models or templates that are subject to copyright, patent or commercial protection supplied to the customer will remain with Würth Elektronik eiSos GmbH & Co. KG. Würth Elektronik eiSos GmbH & Co. KG does not warrant or represent that any license, either expressed or implied, is granted under any patent right, copyright, mask work right, or other intellectual property right relating to any combination, application, or process in which Würth Elektronik eiSos GmbH & Co. KG components or services are used.

8. General Terms and Conditions

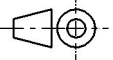
Unless otherwise agreed in individual contracts, all orders are subject to the current version of the "General Terms and Conditions of Würth Elektronik eiSos Group", last version available at www.we-online.com.

Würth Elektronik eiSos GmbH & Co. KG EMC & Inductive Solutions Max-Eyth-Str. 1 74638 Waldenburg Germany Tel. +49 (0) 79 42 945 - 0 www.we-online.com eiSos@we-online.com		CREATED KaS	CHECKED ZAn	GENERAL TOLERANCE DIN ISO 2768-1m	PROJECTION METHOD 	
		DESCRIPTION WL-SWTP SMD White Top View PLCC LED			ORDER CODE 158301260	
		SIZE 3014	REVISION 004.000	STATUS Valid	DATE 2016-07-21	BUSINESS UNIT eiPal