

1

2

3

4

5

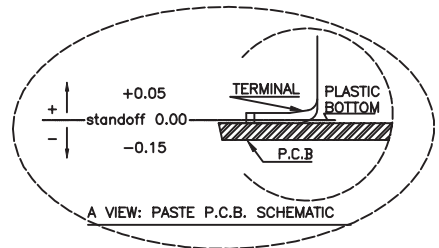
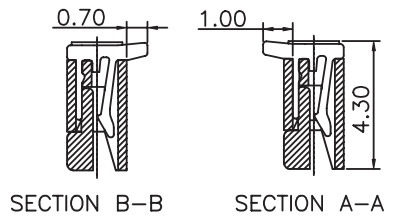

MATERIAL:
 HOUSING MATERIAL: LCP
 COLOR: IVORY
 ACTUATOR MATERIAL: LCP
 COLOR: BLACK
 CONTACT MATERIAL: PHOSPOR BRONZE
 CONTACT PLATING: 100µ TIN OVER 50µ NI
 QUALITY CLASS: 25 MATING CYCLES*

ENVIRONNEMENTAL:
 OPERATING TEMPERATURE: -25°C UP TO 85°C
 FLAMMABILITY RATING: UL94-V0
 COMPLIANCE: LEAD FREE AND ROHS

ELECTRICAL:
 CURRENT RATING: 0.5A
 WORKING VOLTAGE: 50V
 INSULATION RESISTANCE: >100MOHM
 DIELECTRIC WITHSTANDING VOLT.: 250VAC/MN
 CONTACT RESISTANCE: 20mOHM MAX

STANDARD
 CERTIFIED: E323964 / MODEL NUMBER 687
 FOLLOWED BY 1, FOLLOWED BY 04 THRU 50, FOLLOWED BY 140 OR 145, FOLLOWED BY NUMERIC DIGITS

SOLDERING:
 REFLOW PROCESS ONLY

PACKAGING
 TAPE & REEL WITH CAP

DIMENSION:
 B = (0.50 x NB PINS) + 6.40
 C = 0.50 x (NB PINS - 1)
 D = 0.50 x (NB PINS + 1) + 0.10
 E = D - 0.10

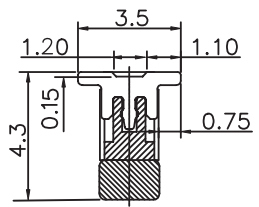
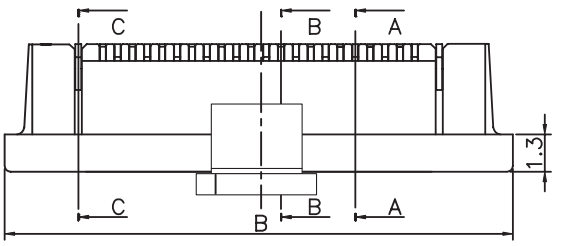

SECTION C-C

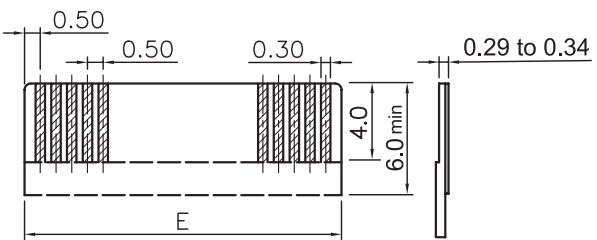
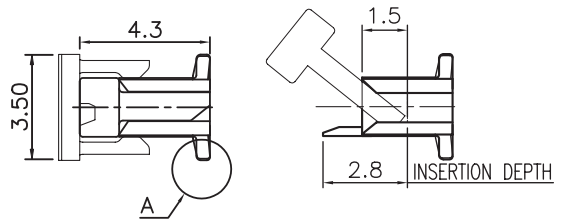
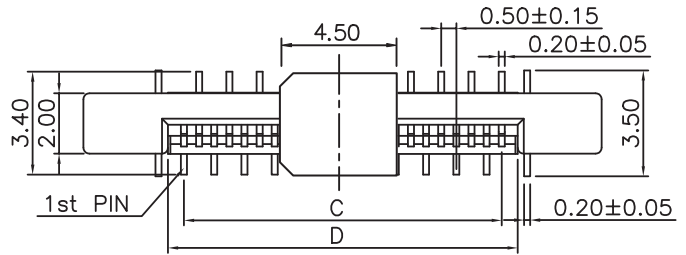

APPLICABLE FFC LAYOUT

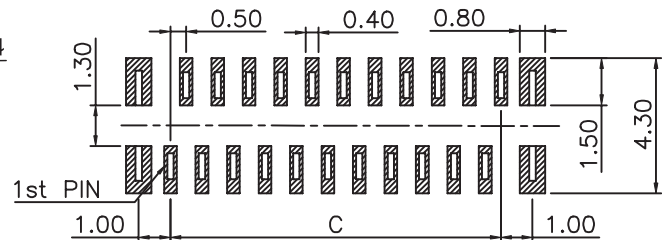



TYPE A RECOMMENDED PCB LAYOUT - COMPONENT VIEW

RoHS Compliant		*NOTE: theoretical value related to the Tin plating; however, due to the sensitive actuator, we recommend not to make more than 1 or 2 cycles in order to maintain acceptable mechanical & electrical conditions			
		PROJECTION: 		GENERAL TOLERANCE .X = +/- 0.2 .XX = +/- 0.15	
		APPROVAL: Gmo			
J	01-JUN-15	TPK UPDATE	QL	UNIT: MM	DESCRIPTION: 0.5MM ZIF FPC VERTICAL CONTACT A TYPE - TAPE & REEL PACKAGING WITH CAP
I	13-DEC-13	TPK UPDATE	QL	SCALE:	
H	18-SEP-12	MC NOTE	GG	SHEET: 1/3	WERI PART NO: 6873 xx 124422
REV	DATE	FILE	BY	DRAW: PEARL	

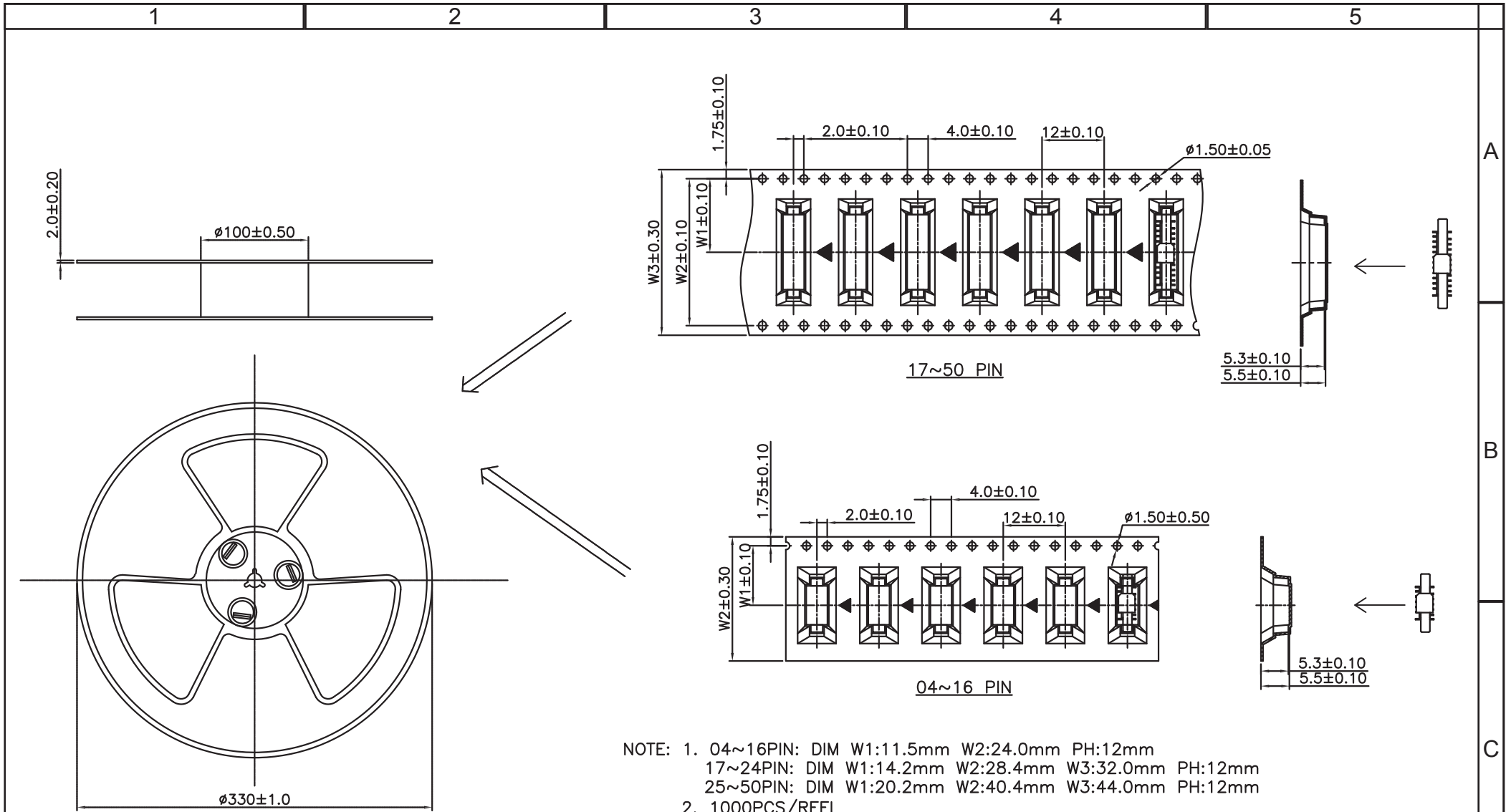
SIZE
A4

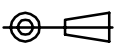

NOTE: 1. 04~16PIN: DIM W1:11.5mm W2:24.0mm PH:12mm
 17~24PIN: DIM W1:14.2mm W2:28.4mm W3:32.0mm PH:12mm
 25~50PIN: DIM W1:20.2mm W2:40.4mm W3:44.0mm PH:12mm
 2. 1000PCS/REEL

RoHS Compliant				PROJECTION: 	GENERAL TOLERANCE .X = +/- 0.2 .XX = +/- 0.15		DESCRIPTION: 0.5MM ZIF FPC VERTICAL CONTACT A TYPE - TAPE & REEL PACKAGING WITH CAP WERI PART NO: 6873 xx 124422	SIZE A4
G								
F								
E								
D								
C			APPROVAL: GmO	UNIT: MM	DESCRIPTION: 0.5MM ZIF FPC VERTICAL CONTACT A TYPE - TAPE & REEL PACKAGING WITH CAP WERI PART NO: 6873 xx 124422		SIZE A4	
B			SCALE:	SHEET: 2/3				
A				DRAW: QL				
REV	DATE	FILE	BY					

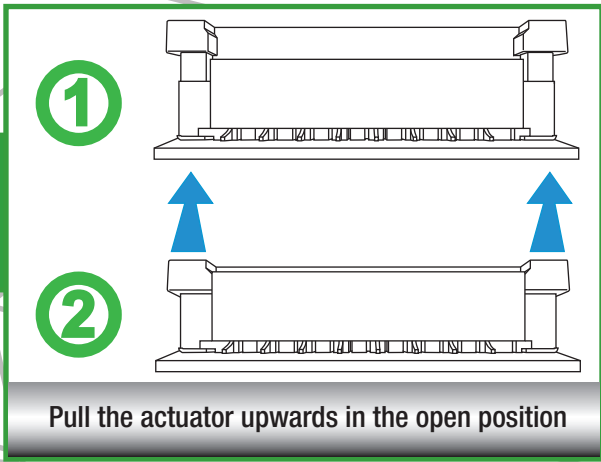

A

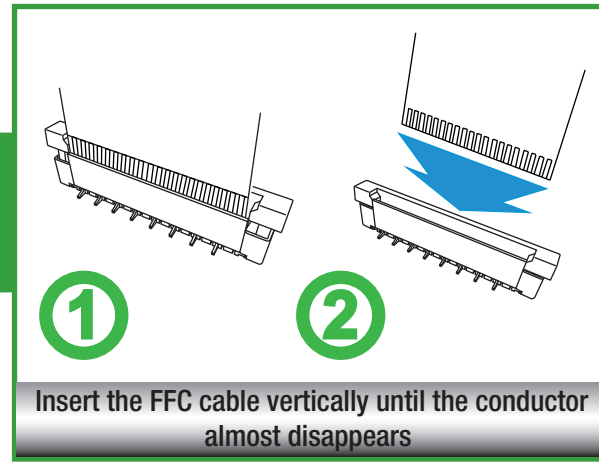

B

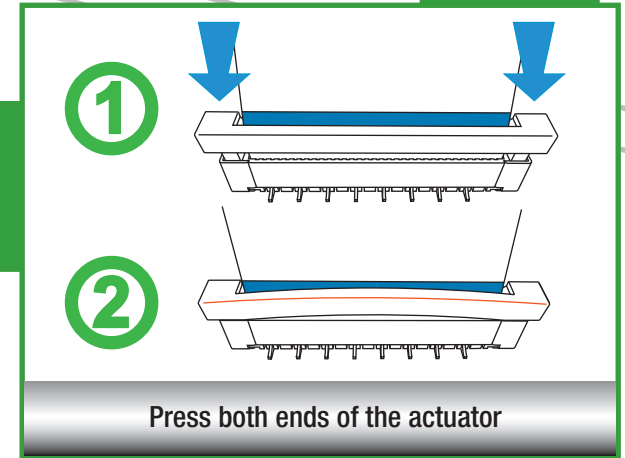
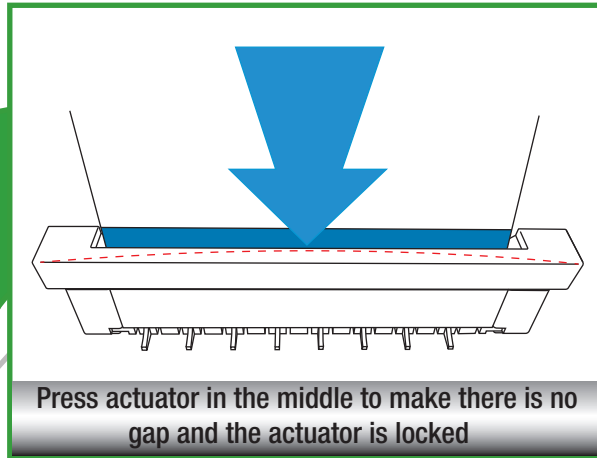

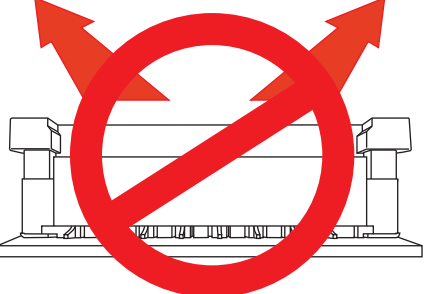

Pull the actuator as horizontally as possible by a proper force

A

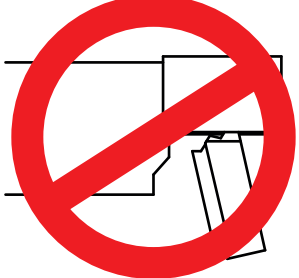

Do not pull the actuator too far otherwise the stop limit (hook on actuator) may be broken

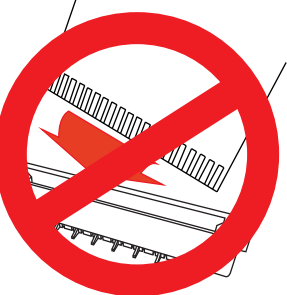

Do not keep FFC inclined when insertion

B

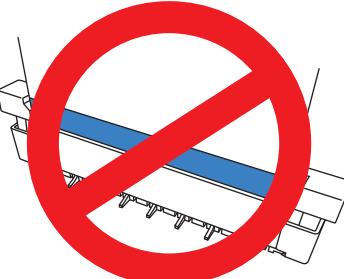

Don't keep conductor toward actuator