

TECHNICAL CHARACTERISTICS

MATERIAL
 INSULATOR: NYLON 46
 FLAMABILITY RATING: UL94-V0
 MAX TEMPERATURE: 260°C 10 S
 COLOR: BLACK
 CONTACT MATERIAL: COPPER ALLOYS
 CONTACT TYPE: STAMPED
 CONTACT PLATING: GOLD
 QUALITY CLASS: 3 AS PER CECC 75 301-802
 PITCH: 2.54MM

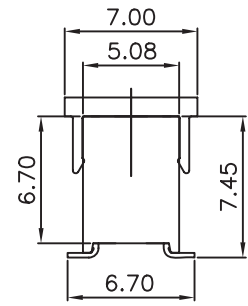
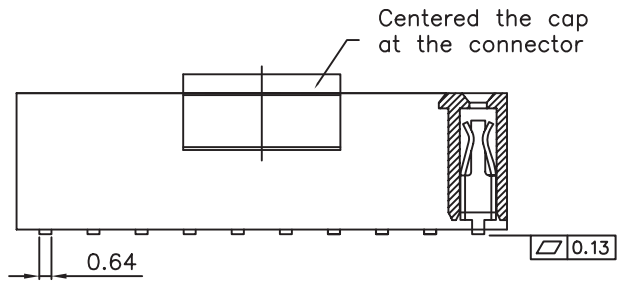

ENVIRONMENTAL
 OPERATING TEMPERATURE: -40 UP TO 105°C
 COMPLIANCE: LEAD FREE AND ROHS

ELECTRICAL
 CURRENT RATING: 3A MAX
 WORKING VOLTAGE: 250V AC
 INSULATOR RESISTANCE: >1000 MOHM
 WITHSTANDING VOLTAGE: 600V AC/MN
 CONTACT RESISTANCE: 20 mOHM MAX

SOLDERING
 JEDEC LEAD FREE REFLOW SOLDERING

PACKAGING
 TAPE & REEL WITH CAP

DIMENSION
 A = 2.54 x (NB. PIN / 2 - 1)
 B = (2.54 x NB. PIN / 2) + 0.5
 CAP
 C = 5.8MM FOR 4, 6, 10, 14... PIN
 C = 8.3MM FOR 8, 12, 16, 20... PIN

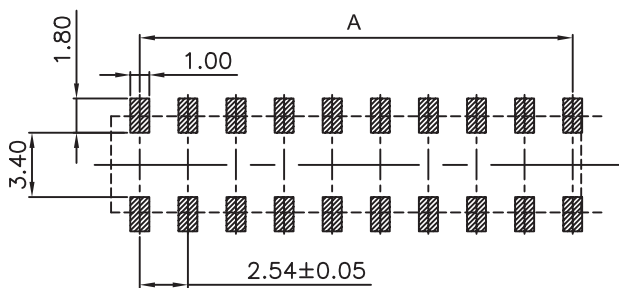

PCB LAYOUT - COMPONENT VIEW

RoHS Compliant				PROJECTION: 	GENERAL TOLERANCE .X = +/- 0.2 .XX = +/- 0.15		DESCRIPTION: PHD 2.54MM DUAL SMT SOCKET HEADER	SIZE A4
G								
F								
E	09-NOV-11	COPLANARITY	GG					
D	31-MAR-10	PACKAGING	JC					
C	25-OCT-10	REEL WIDTH	JC	APPROVAL: GM	UNIT: MM	DESCRIPTION: PHD 2.54MM DUAL SMT SOCKET HEADER		SIZE A4
B	21-APR-09	DIMENSION CAP	JP		SCALE:	WERI PART NO: 610 3xx 218 21		
A	31-OCT-07	PDF	CH		SHEET: 1/2			
REV	DATE	FILE	BY		DRAW: MARY			

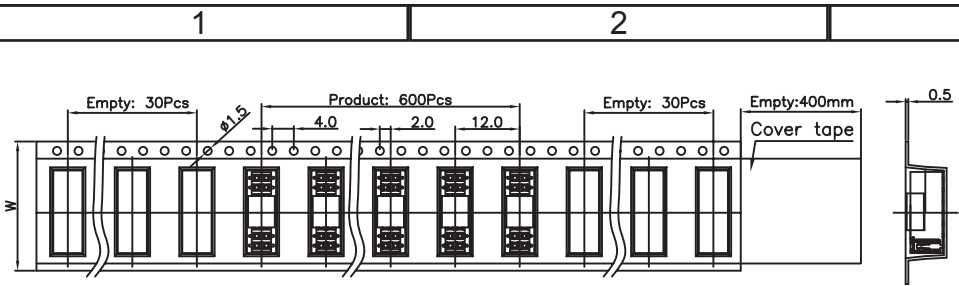

For Reel width (dimension W)16,24mm ,Single row hole

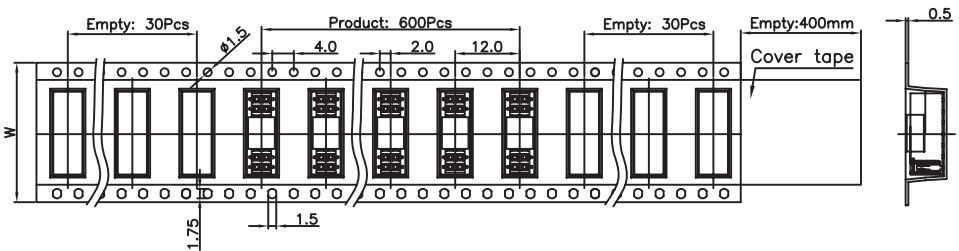

For Reel width (dimension W)32,44,56,72mm ,Double rows hole

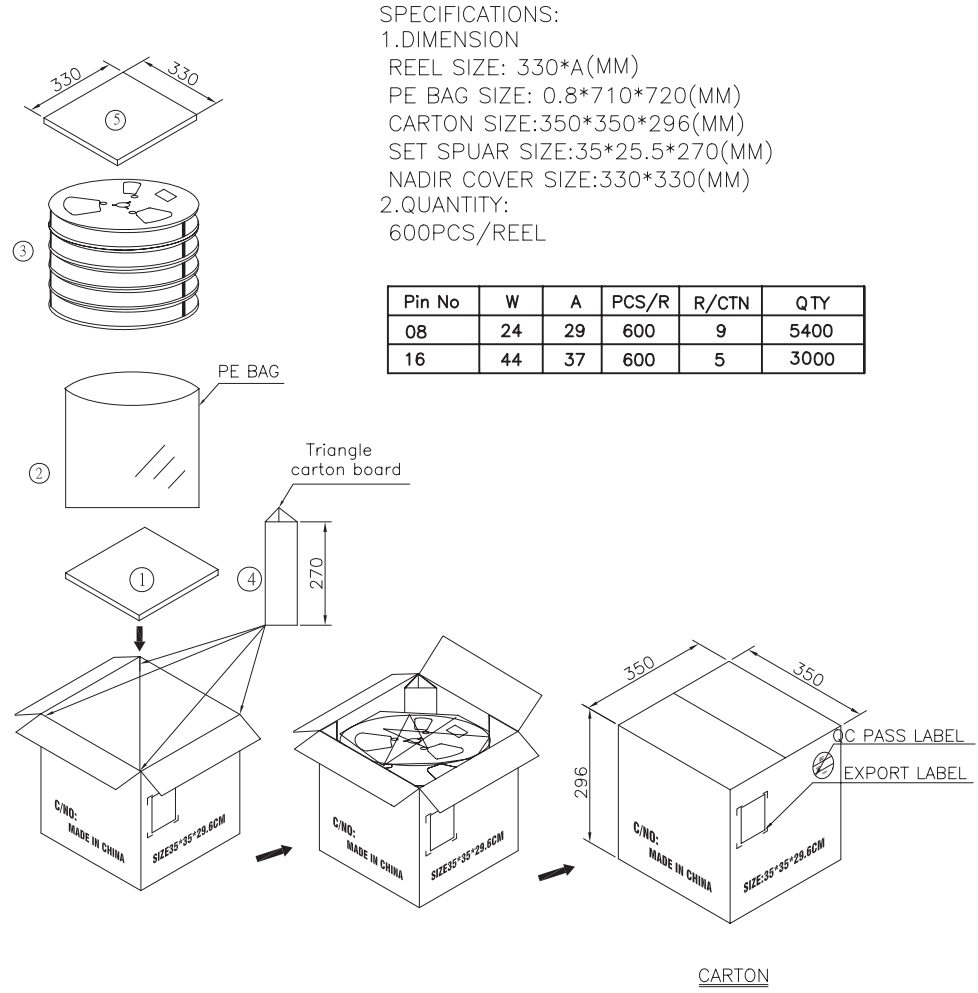
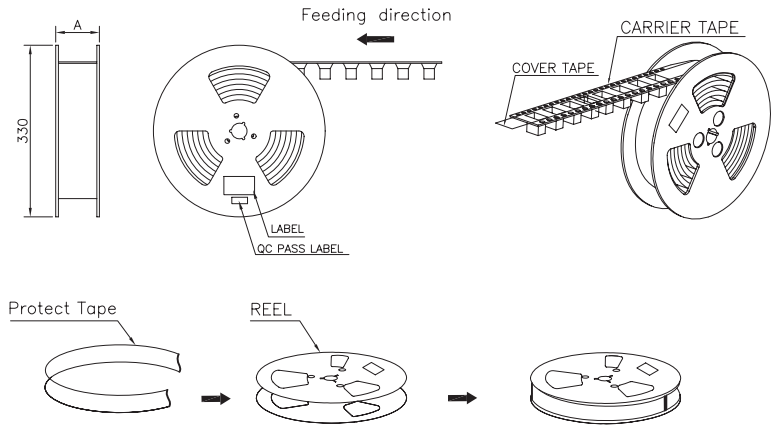

SPECIFICATIONS:
 1.DIMENSION
 REEL SIZE: 330*A(MM)
 PE BAG SIZE: 0.8*710*720(MM)
 CARTON SIZE:350*350*296(MM)
 SET SPUAR SIZE:35*25.5*270(MM)
 NADIR COVER SIZE:330*330(MM)
 2.QUANTITY:
 600PCS/REEL

Pin No	W	A	PCS/R	R/CTN	QTY
08	24	29	600	9	5400
16	44	37	600	5	3000

RoHS Compliant			
G			
F			
E			
D			
C			
B			
A			
REV	DATE	FILE	BY

PROJECTION:	GENERAL TOLERANCE
	.X = +/- 0.2
	.XX = +/- 0.15
APPROVAL: RJ	UNIT: MM
	SCALE:
	SHEET: 2/2
	DRAW: MARY

DESCRIPTION: PHD 2.54MM DUAL SMT SOCKET HEADER	
WERI PART NO: 6103 xx 21821	

SIZE
A4