

Oct.1.2018 Copyright 2018 HIROSE ELECTRIC CO., LTD. All Rights Reserved.
 In case that the application demands a high level of reliability, such as automotive,
 please contact a company representative for further information.

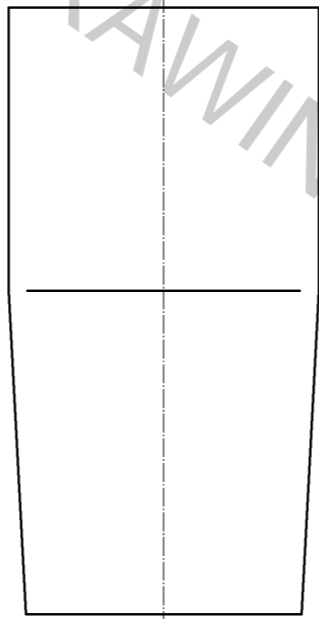

1 FIGURE-1 CONTACT No. MARKING (10:1)

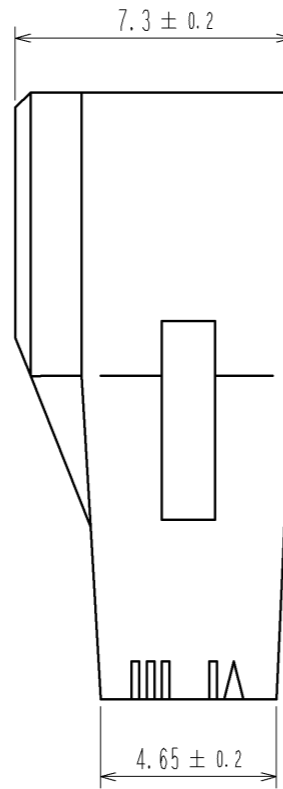
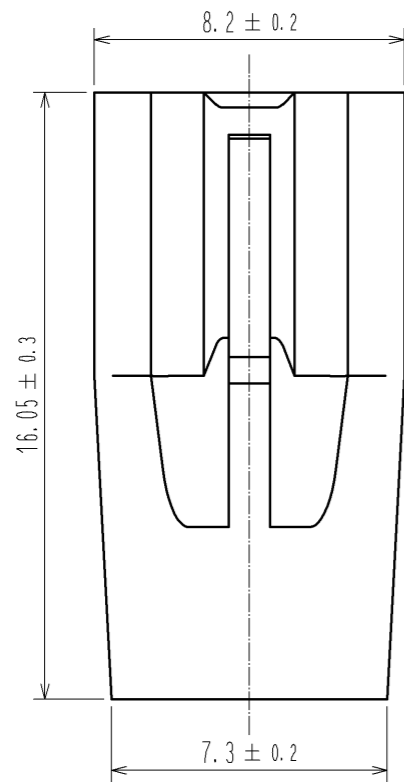
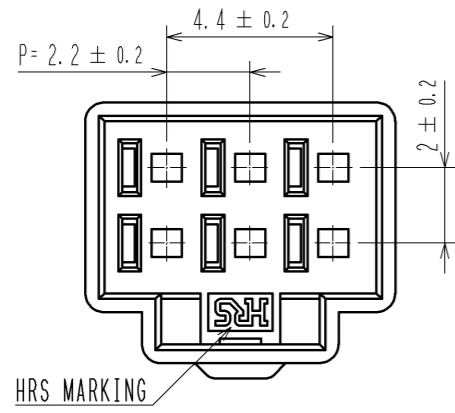
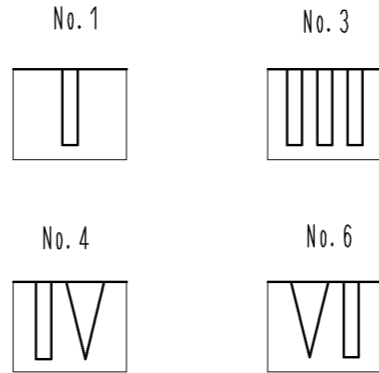

MATING FIGURE

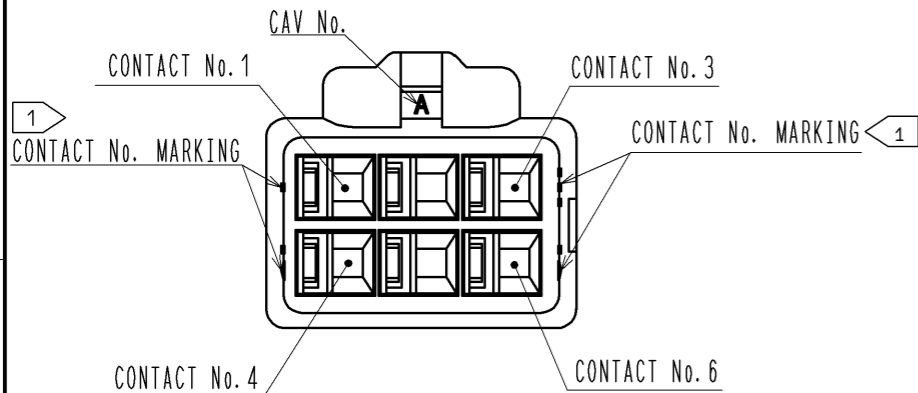
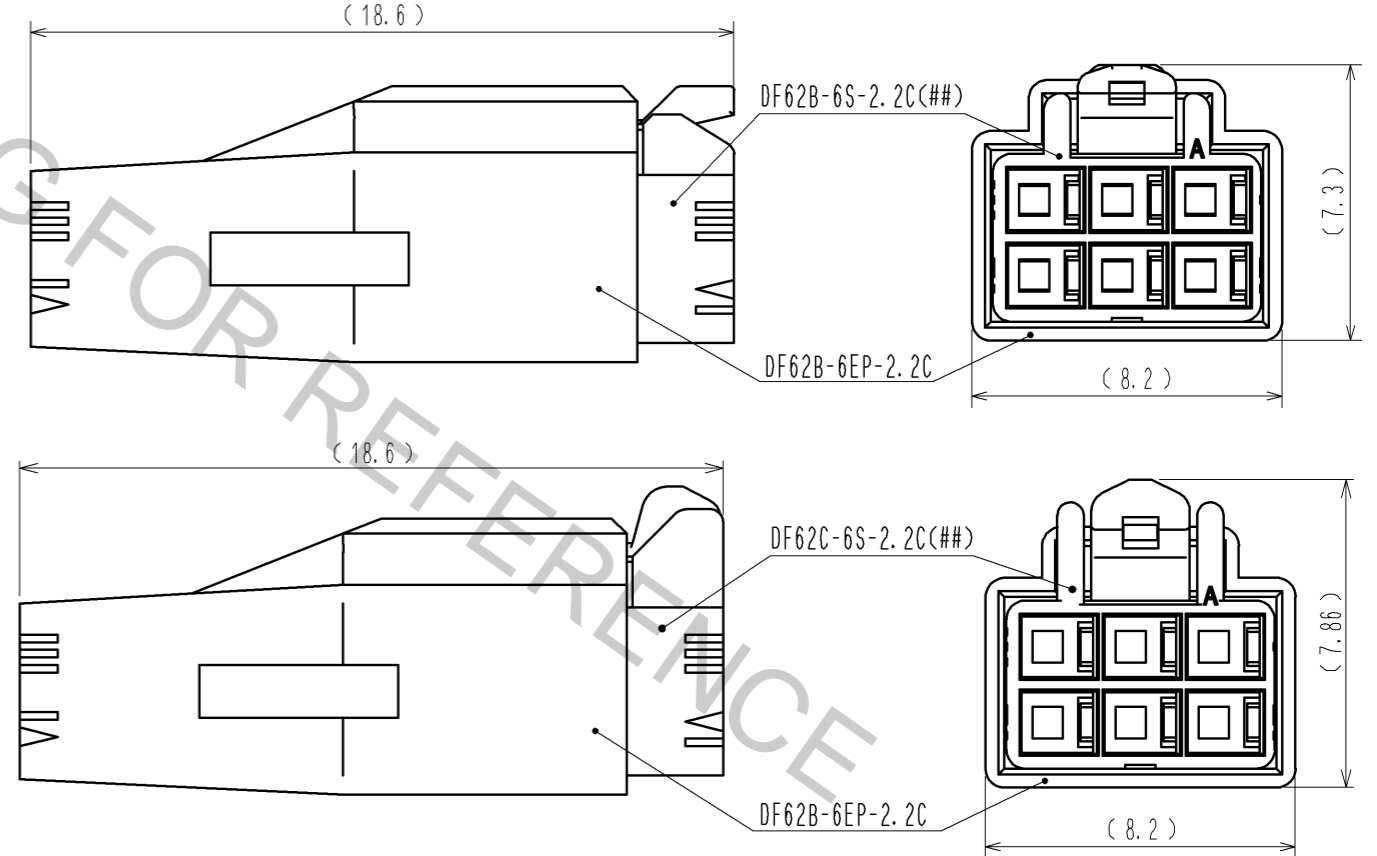

NOTE. 1 MARKINGS AT THE INDICATED POSITIONS ARE CONTACT NO. MARKING. AND SHAPES ARE SHOWN IN FIGURE-1.
 2. PER PACK : 100 PIECES.
 3. THE DIMENSIONS IN PARENTHESIS ARE FOR REFERENCE.

NO.		MATERIAL		FINISH . REMARKS		1	PBT	UL94V-0 (BLACK)		
UNITS		SCALE		COUNT		DESCRIPTION OF REVISIONS		DESIGNED	CHECKED	DATE
mm		5 : 1		△						
HIROSE ELECTRIC CO., LTD.		APPROVED : KI. AKIYAMA		13.05.28		DRAWING NO.		EDC3-351967-00		
		CHECKED : HK. UMEHARA		13.05.28		PART NO.		DF62B-6EP-2.2C		
		DESIGNED : TS. KUMAZAWA		13.05.28		CODE NO.		CL544-0562-6-00		
		DRAWN : TS. KUMAZAWA		13.05.28				1/1		