

Verpackt im Gurt nach DIN IEC 60286-3
 Tape on Reel Packaging according to DIN IEC 60286-3
 Verpackungseinheit: 280 Stück
 Packaging unit: 280 pcs

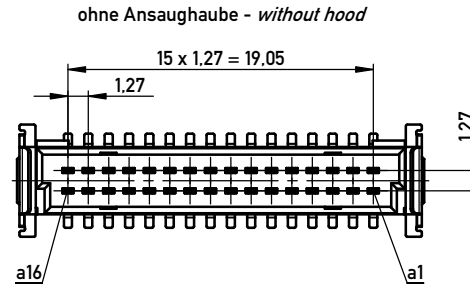

Abspulrichtung - Reel off Direction

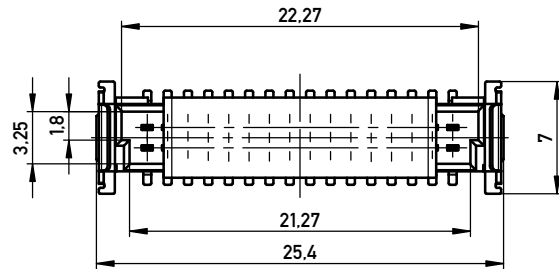
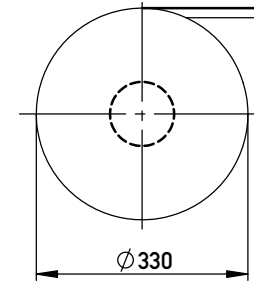
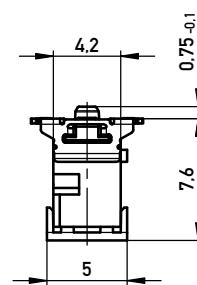
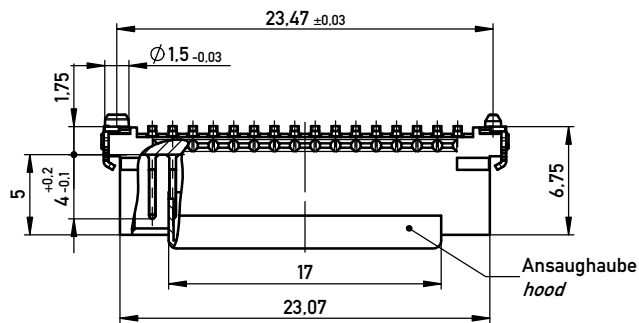
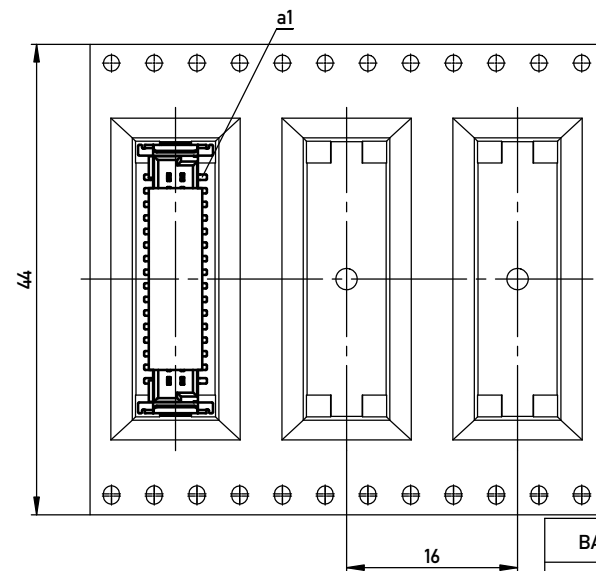

Leiterplatten-Layout Vorschlag für SMT
 PCB-Layout Proposal for SMT

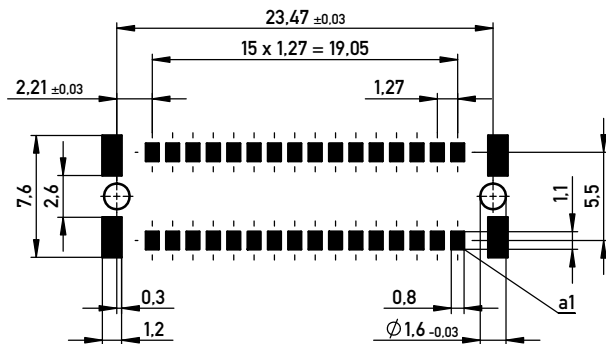

Anforderungsstufe 1
 Performance Level 1

Kontaktbereich vergoldet
 Mating Area gold plating

Anschlussbereich verzinkt 4-6 µm
 Terminal Area 4-6 µm tin plating

Koplanarität der Anschlüsse ≤ 0.1 mm
 Coplanarity Area of Termination ≤ 0.1 mm

BA 8-13 - 8mm Bauhöhe
 type 8-13 - Low Profile

Copyright by ERNI GmbH
 Proprietary notice pursuant to ISO 9006 to be observed.

Information:		Tolerances	 All Dimensions in mm	Scale 3:1
All rights reserved. Only for Information. To ensure that this is the latest version of this drawing, please contact one of the ERNI companies before using.		Subject to modification without prior notice. Drawing will not be updated.		Designation Messerl. SMC-Q 32-SMD-BA8-13 Male SMC-Q 32-SMD-type8-13
www.ERNI.com		254589		I A3
e	14.07.2015	Class		SMCQ
Index	Date			