

Verpackt im Gurt in Anlehnung an DIN IEC 60286-3
 Tape on Reel Packaging according to DIN IEC 60286-3
 Verpackungseinheit: 500 Stück
 Packaging unit: 500 pcs

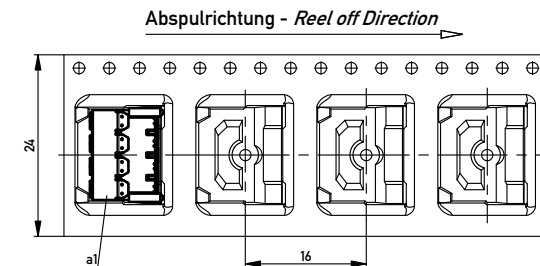

Leiterplatten-Layout Vorschlag / PCB-layout proposal

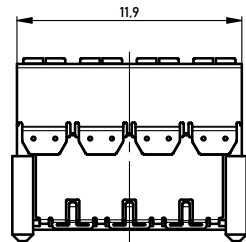
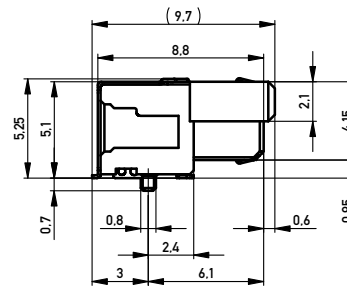
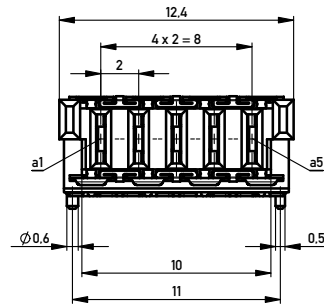
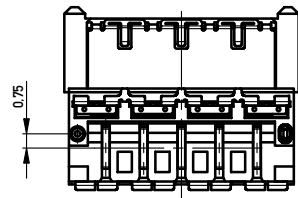
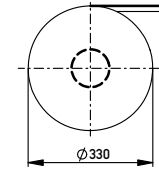
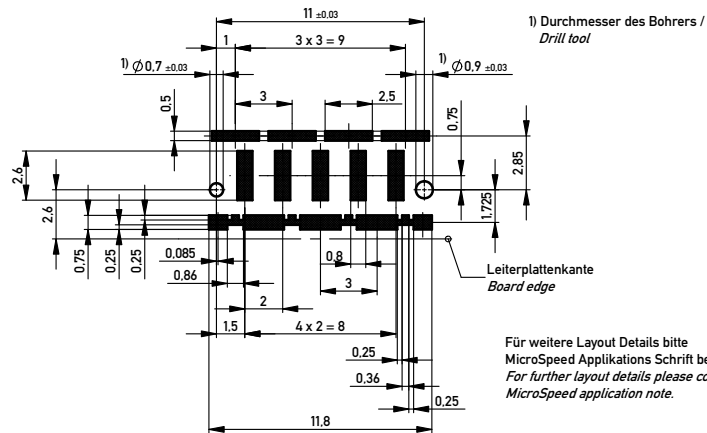

Für weitere Layout Details bitte
 MicroSpeed Applikations Schrift beachten.
 For further layout details please consider
 MicroSpeed application note.

Anforderungsstufe 1
 Performance Level 1

Kontaktbereich vergoldet
 Mating Area gold plating

Anschlussbereich verzinkt 4-6 µm
 Terminal Area 4-6 µm tin plating

Koplanarität der Anschlüsse ≤ 0,1 mm
 Coplanarity Area of Termination ≤ 0,1 mm

BlindMate SMD

Information:		Tolerances		Scale	5:1
All rights reserved. Only for Information. To ensure that this is the latest version of this drawing, please contact one of the ERNI companies before using.		All Dimensions in mm		Designation	
Subject to modification without prior notice. Drawing will not be updated.				MSpeed Federl. 90° PM MSpeed female 90° PM	
d	27.05.2015	www.ERNI.com		364707	
Index	Date	Class		MSPPM	
				I A2	

Copyright by ERNI Production GmbH & Co. KG
 Proprietary notice pursuant to ISO 16949 to be observed