

REV	ECN	DESCRIPTION	BY	DATE	APPROVED
A	JLIU-22111522	RELEASE TO PRODUCTION	J.LIU	11/28/2022	J.LIU

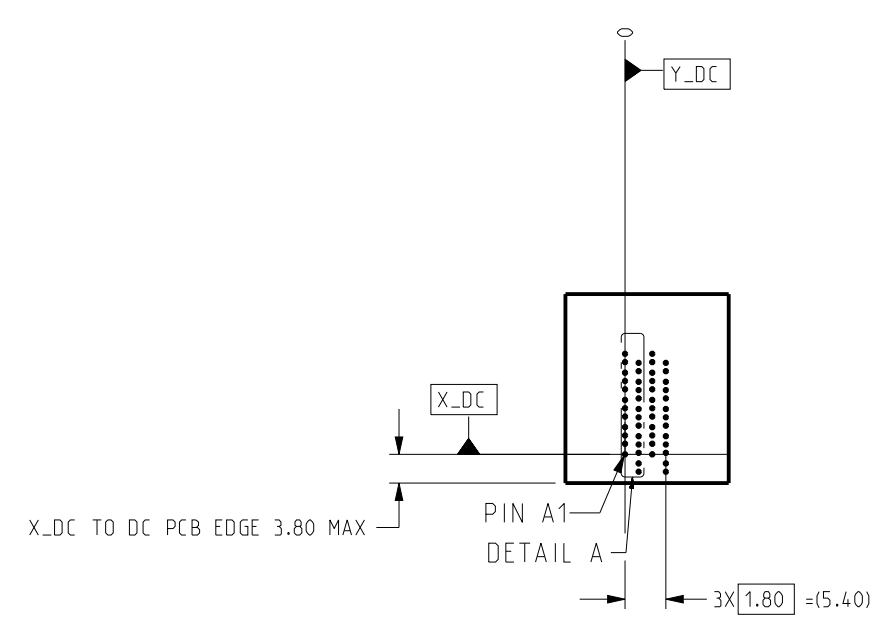

FRONT VIEW - DC HOLE PATTERN ONLY . CONNECTOR SIDE REFERENCED FROM LEFT MOST SIGNAL COLUMN ; ALL DIMENSIONS BASIC

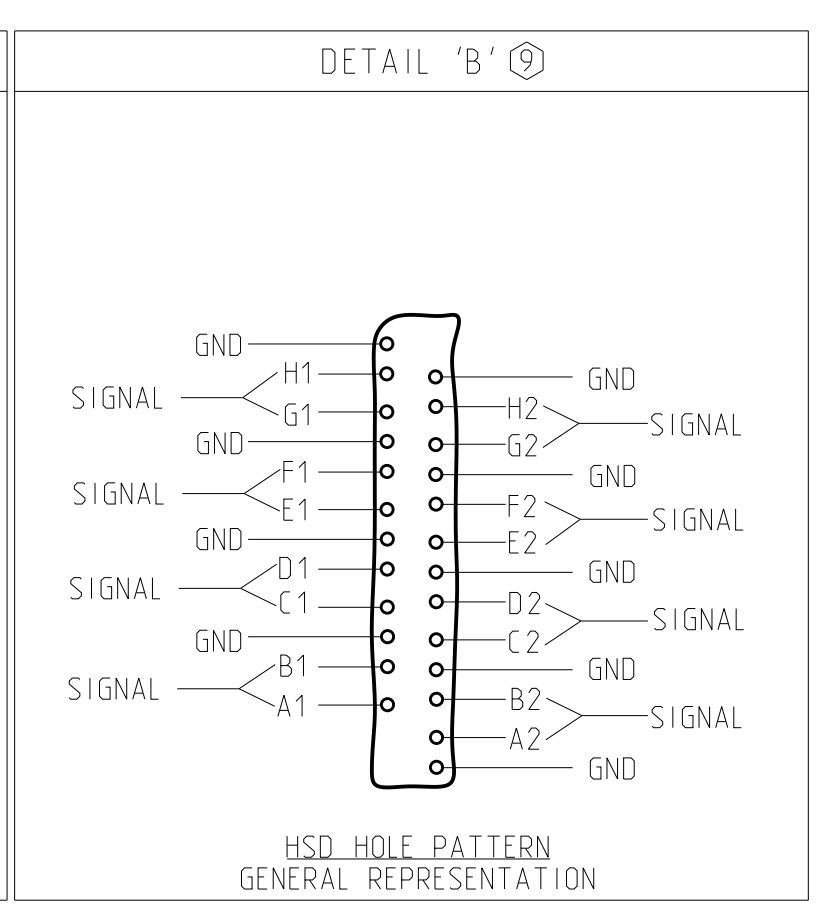
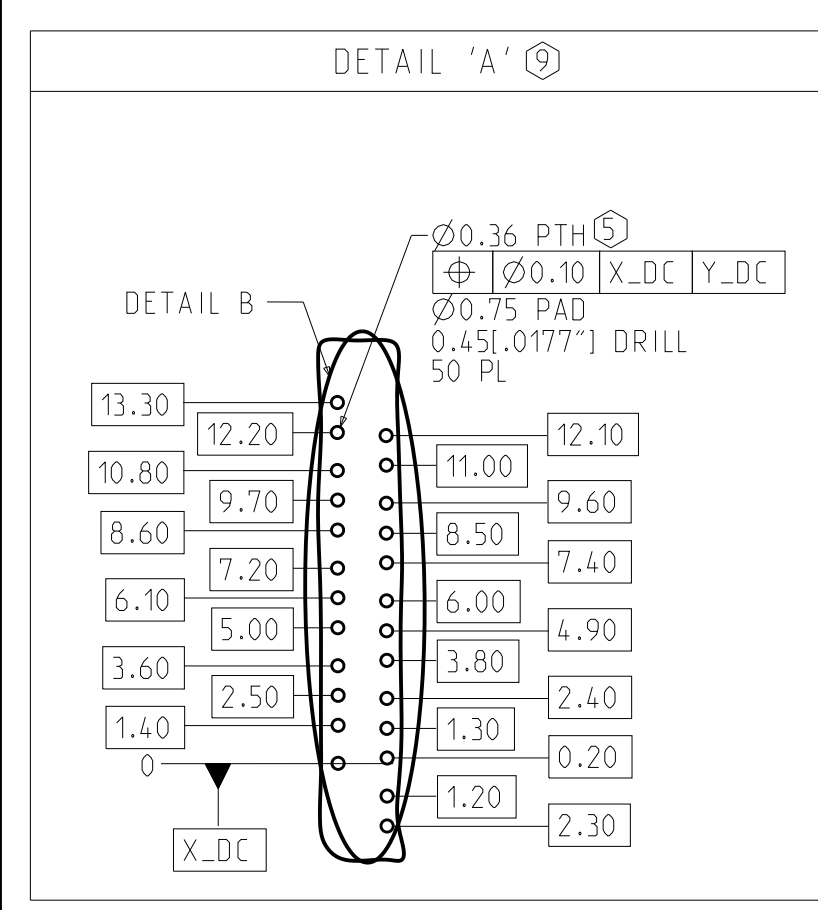
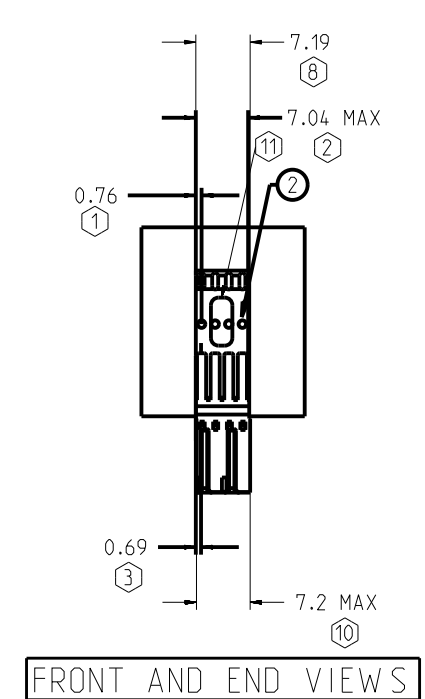

FRONT AND END VIEWS

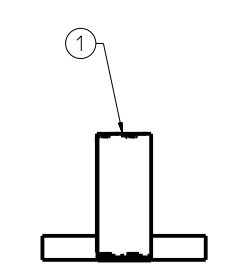
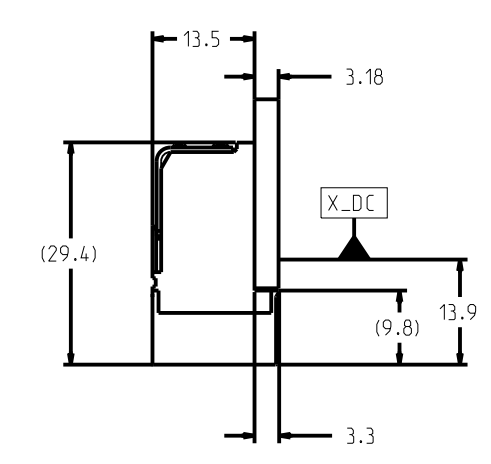

BOTTOM VIEW MODULE LOCATIONS FROM LEFT END OF PLASTIC

ITEM	PART NUMBER	DESCRIPTION	QTY
1	922-471C-D3H	XCede HD 4PAIR HSD MOD w/ ORGANIZER, 4POS, 85OHMS, BIFURCATED, .0177" DRILL, NANO NI, STD GOLD	1
2	617-0450-007	XCede HD 4PAIR STIFFENER	1

NOTE: SEE FRONT VIEW FOR STIFFENER LENGTH.

NOTES:

- ① DISTANCE FROM FIRST STIFFENER PILOT HOLE TO LEFT END OF STIFFENER.
- ② TOTAL LENGTH OF STIFFENER.
- ③ DISTANCE FROM CENTERLINE OF 1ST COLUMN OF SIGNAL PLATED THRU HOLES TO LEFT EDGE OF STIFFENER.
- ④ MOUNTING SCREWS AND JOINER MODULES (IF PRESENT) TO BE BAGGED WITH EACH CONNECTOR ASSEMBLY.
- ⑤ STATED PAD SIZE MAY REQUIRE FILLETING. SEE TB-2237 FOR ROUTING, HOLE WALL PLATING THICKNESS AND FINISHED HOLE SIZE.
- ⑥ NA.
- ⑦ REFER TO TB-2235 FOR XCede HD PRODUCT SPECIFICATIONS.
- ⑧ OVERALL CONNECTOR LENGTH.
- ⑨ DETAIL VIEWS ARE NOT TO SCALE. DO NOT SCALE DRAWING.
- ⑩ FRONT HOUSING WIDTH. CONNECTORS CAN BE USED IN STACKABLE APPLICATION.
- ⑪ CONNECTOR IS LASER MARKED WITH MANUFACTURING INFORMATION.
- ⑫ REFER TO DRAWING C-527-4133-000 FOR MARKING REQUIREMENTS AND DETAILS.

CUSTOMER: DISTRIBUTOR / XHD 4PAIR X 4. HSD 85OHMS

TOLERANCES	DESIGN	DATE
0.0	±0.25	10/12/2022
0.00	±0.13	10/12/2022
0.000	±	10/12/2022
ANGLES	± 3°	11/28/2022

**Amphenol TCS**  
A Division of Amphenol Corporation  
200 Innovative Way, Nashua, NH 03062 803.879.3000

TITLE: XCede HD DAUGHTERCARD ASSEMBLY  
4 PAIR CONNECTOR, LEADFREE

PART NO. JX410-51601  
DRAWING NO. C-JX410-51601

UNLESS OTHERWISE SPECIFIED DIMENSIONS ARE IN MM AND DECIMAL MARKER IS A PERIOD.

SCALE 1/1 SHEET 1 OF 2

INTERPRET PER ANSI Y14.5  
CODE IDENT 31413

CUSTOMER USE DRAWING

AMPHENOL TCS/DC HD CONDUCTOR: VER02/03

REV	ECN	DESCRIPTION	BY	DATE	APPROVED
		SEE SHEET 1			

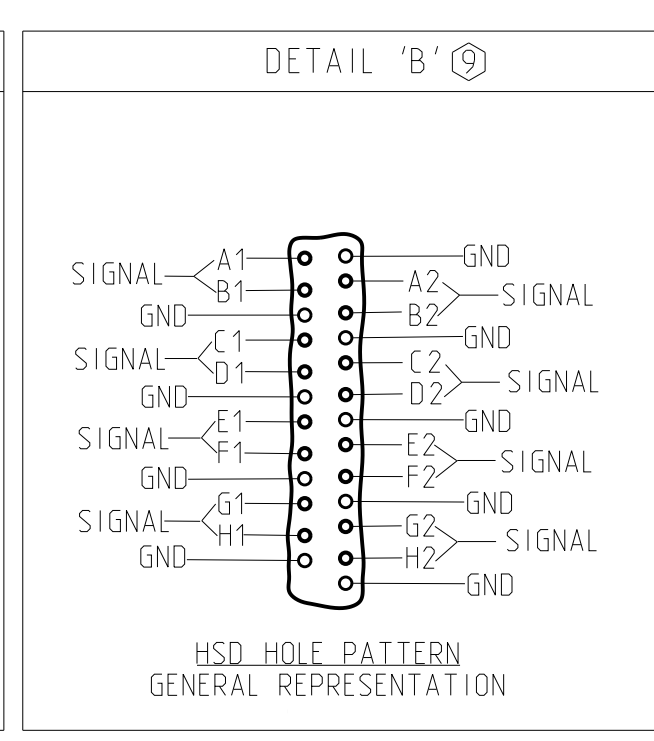
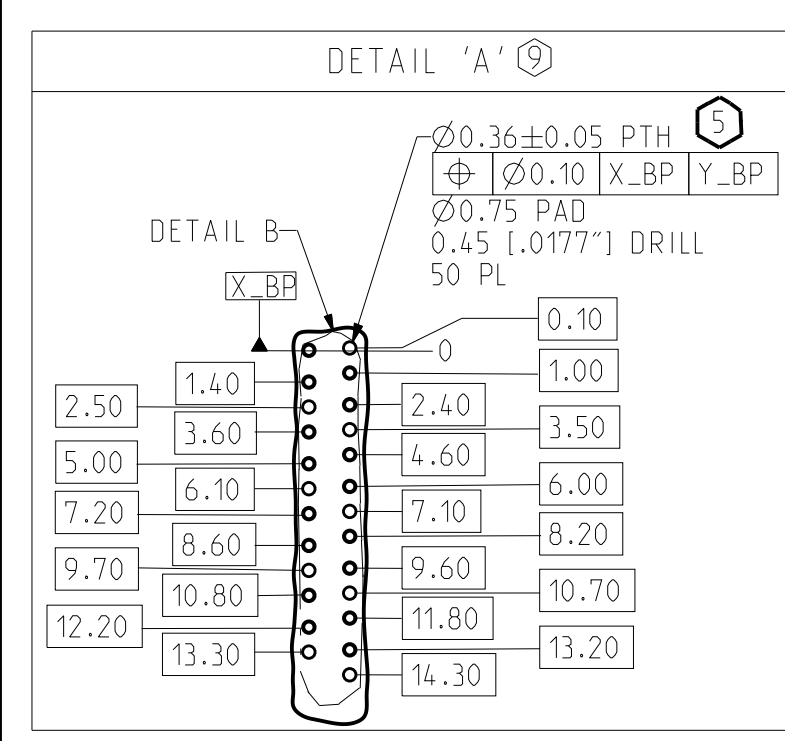

FOR REFERENCE ONLY; FOR SPECIFIC DETAILS, SEE C-USE DRAWINGS FOR BACKPLANE MODULES IN TABLE 2  
 BACKPLANE COMPONENTS MUST BE PURCHASED SEPARATELY AND MAY DIFFER FROM EXAMPLE SHOWN

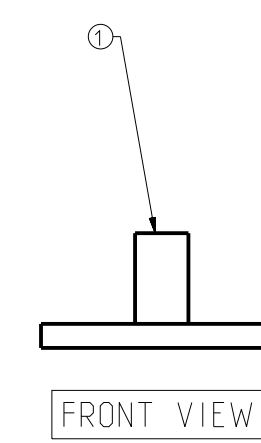
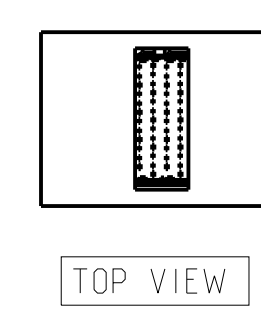
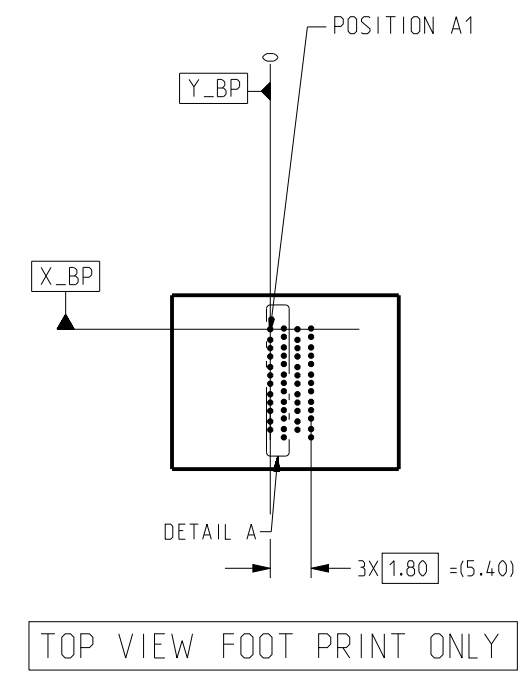

ITEM	PART NUMBER	DESCRIPTION	QTY
1	923-400J-40H	XCede HD 4PAIR 4POS. OPEN, 3MM W IPE, .0177" DRILL, NANO NI, STD GOLD	1

CUSTOMER: DISTRIBUTOR / XHD 4PAIR X 4, HSD 850HMS

TOLERANCES	DESIGN	DATE	DESIGNER
0.0	±0.25	10/12/2022	J.LIU
0.00	±0.13	10/12/2022	AUTO GENERATED
0.000	± -	10/12/2022	J.LIU
ANGLES	± 3°	11/28/2022	J.LIU

<b>Amphenol TCS</b> A Division of Amphenol Corporation 200 Innovative Way, Nashua, NH 03062 803.879.3000		TITLE XCede HD BACKPLANE ASSEMBLY 4 PAIR CONNECTOR, LEADFREE
PART NO.	JX410-51601	REV A
DRAWING NO.	C-JX410-51601	
CRED FILES JX410-51601_BP_ASM JX410-51601_BP.DRW		
SIZE	D	SCALE 1/1
		SHEET 2 OF 2

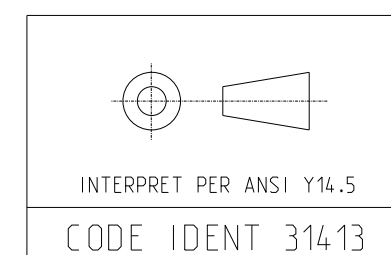

CUSTOMER USE  
 DRAWING