

ORDERING CODE: FLH - CXX - XX - X XX

FLH SERIES

CABLE CONFIGURATION
SEE TABLE 1

HOUSING COLOR
00 = BLACK HOUSING
W0 = WHITE HOUSING

WIRE GAUGE
8 = 18 AWG
0 = 20 AWG
2 = 22 AWG

WIRE LENGTH 'L'

CODE	WIRE LENGTH 'L'
10 TO 99	LENGTH IN CM
A0 TO A9	1 METER+ 0 TO 9 DECIMETER
B0 TO B9	2 METER+ 0 TO 9 DECIMETER
C0 TO C9	3 METER+ 0 TO 9 DECIMETER
D0 TO D9	4 METER+ 0 TO 9 DECIMETER
E0 TO E9	5 METER+ 0 TO 9 DECIMETER
F0 TO F9	6 METER+ 0 TO 9 DECIMETER
G0 TO G9	7 METER+ 0 TO 9 DECIMETER
H0 TO H9	8 METER+ 0 TO 9 DECIMETER
J0 TO J9	9 METER+ 0 TO 9 DECIMETER
K0 TO K9	10 METER+ 0 TO 9 METER
L0 TO L9	20 METER+ 0 TO 9 METER
M0 TO M9	30 METER+ 0 TO 9 DECAMETER

EXAMPLE: 75 CM = 75, 25 M = L5, 80 M = M5

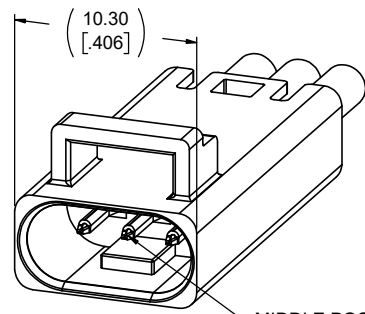

MIDDLE POSITION VACANT FOR 2 POSITION CONNECTOR

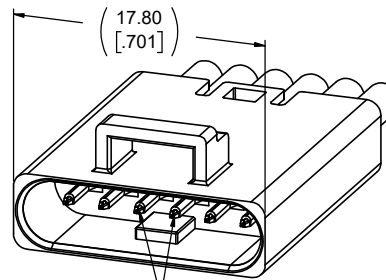

MIDDLE 2 POSITIONS VACANT FOR 4 POSITION CONNECTOR

SOCKET CONNECTORS NOT SHOWN

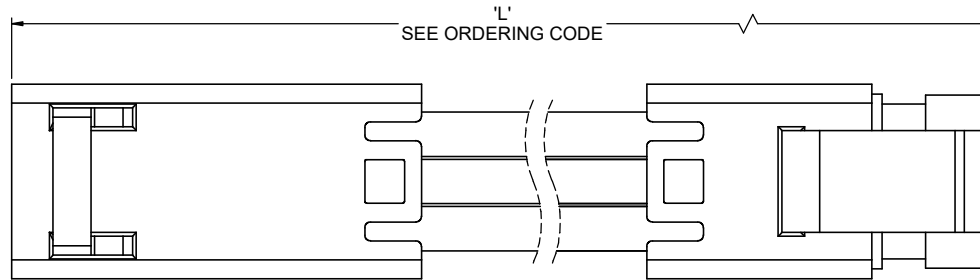

3 POSITION CABLE ASSEMBLY SHOWN

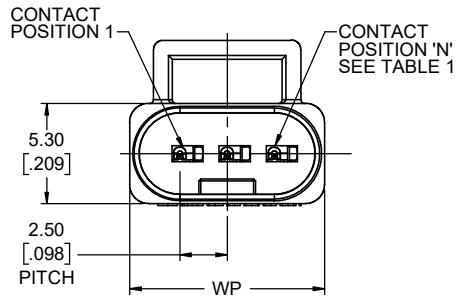

SEE TABLE 1

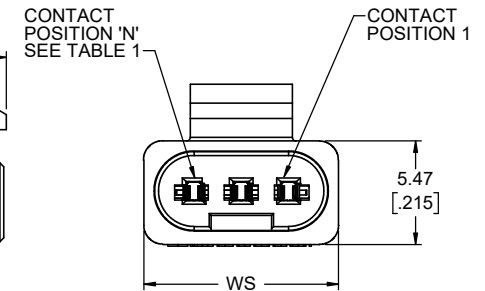
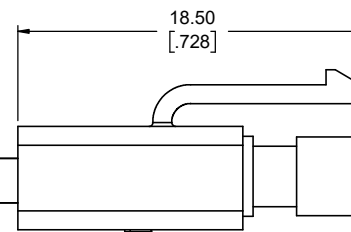
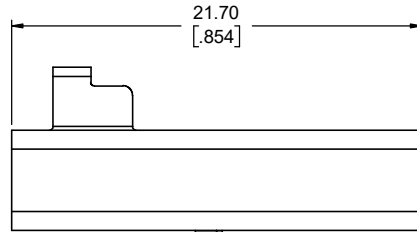

NOTES:

- MATERIALS:** ALL MATERIALS ARE RoHS COMPLIANT PER EU DIRECTIVE 2011/65/EU & AMENDMENTS
 - HOUSING: ENGINEERING THERMOPLASTIC, UL FLAMMABILITY RATING 94V-0, COLOR PER ORDERING CODE
 - WIRE: TINNED COPPER CONDUCTOR, PVC INSULATION FOR 18, 20 & 22 AWG WIRES, COLOR BLACK
- ELECTRICAL CHARACTERISTICS:**
 - CURRENT RATING: 7A (18 AWG OR 1mm²) OR 5A (20 AWG OR 0.5 mm²) OR 3A (22 AWG OR 0.34 mm²) PER CONTACT
 - DIELECTRIC WITHSTANDING VOLTAGE: 1500 VAC
 - INSULATION RESISTANCE: 500 MEGAOHMS
 - OPERATING TEMPERATURE: -40 °C TO +105 °C
- IP20 PROTECTION PER IEC 60529

CABLE CONFIGURATION		NO. CONTACTS 'N'	WIDTH 'WP'	WIDTH 'WS'
STRANDED WIRE	SOLID WIRE			
C2C	C2P	2	10.30 [.406]	10.30 [.406]
C3C	C3P	3		
C4C	C4P	4	17.80 [.701]	17.80 [.701]
C6C	C6P	6		



UNLESS SPECIFIED OTHERWISE	DRAWN	S.MUGAN	JUN02/22
PRIMARY UNITS MILLIMETERS	CHECKED		
SECONDARY INCHES	M.E. APP'D		
REFERENCE IN PARENTHESES	Q.A. APP'D		
GENERAL TOLERANCES	DWG APPR.		
1 DECIMAL PLACE	ENG. REL. NO.		
2 DECIMAL PLACES ±0.10	REF.		
3 DECIMAL PLACES	THIRD ANGLE PROJECTION		
ANGULAR DEGREES	DO NOT SCALE DRAWING		

Amphenol Canada Corp.
Commercial Products

FLH SERIES, MINI 2.5mm PITCH
PLUG / RECEPTACLE CABLE ASSEMBLY,
RoHS COMPLIANT

DWG. NO. _____ REV. C

P-FLH-CXX-XX-XXX

CODE ID NO. 03554 DWG SIZE: X SCALE: 5:1 SHEET 1 OF 1

REVISIONS			
REV	DESCRIPTION, ECN, EAR NO.	DATE	APP'D
A	PRODUCT DWG - NEW PER EAR 15074	JUN02/22	S.M.
B	PRODUCT DWG - REV PER EAR 15058	JUL25/22	S.M.
C	PRODUCT DWG - REV PER EAR 15058	AUG09/22	S.M.