



PART NO.

SL-19 + SL-6 - Series

REVISIONS

ECN #	REV	DESCRIPTION	DRAWN	DATE	CHECKD	DATE	APPRVD	DATE
-	A	RELEASED	Veena	19/04/10	Jagan	19/04/10	Farnell	03/05/10

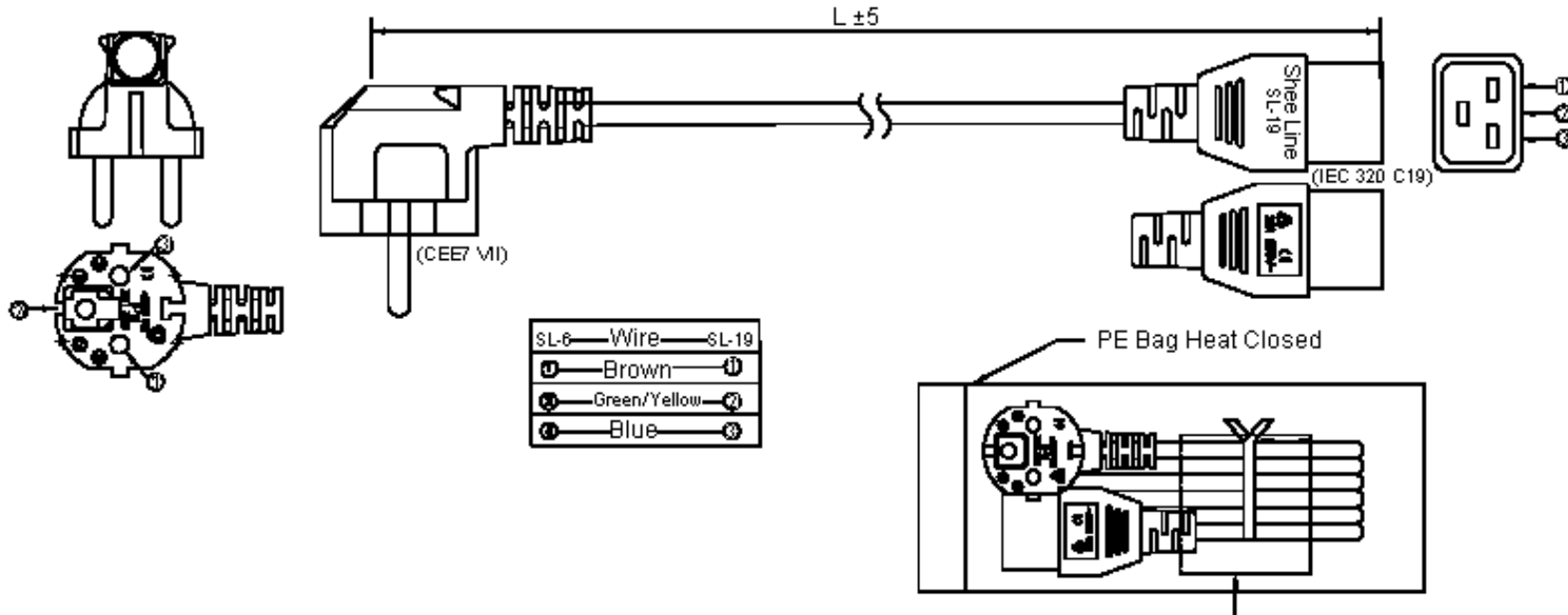

SL-6	Wire	SL-19
1	Brown	1
2	Green/Yellow	2
3	Blue	3

Dimensions: Millimetres

This data sheet and its contents (the "Information") belong to the Premier Farnell Group (the "Group") or are licensed to it. No licence is granted for the use of it other than for information purposes in connection with the products to which it relates. No licence of any intellectual property rights is granted. The Information is subject to change without notice and replaces all data sheets previously supplied. The Information supplied is believed to be accurate but the Group assumes no responsibility for its accuracy or completeness, any error in or omission from it or for any use made of it. Users of this data sheet should check for themselves the Information and the suitability of the products for their purpose and not make any assumptions based on information included or omitted. Liability for loss or damage resulting from any reliance on the Information or use of it (including liability resulting from negligence or where the Group was aware of the possibility of such loss or damage arising) is excluded. This will not operate to limit or restrict the Group's liability for death or personal injury resulting from its negligence. SPC MULTICOMP is the registered trademark of the Group. © Premier Farnell plc 2010.

TOLERANCES:
UNLESS OTHERWISE SPECIFIED, DIMENSIONS ARE FOR REFERENCE PURPOSES ONLY.

DRAWN BY:	DATE:
Veena	19/04/10
CHECKED BY:	DATE:
Jagan	19/04/10
APPROVED BY:	DATE:
Farnell	03/05/10

DRAWING TITLE:			
IEC Lead - C19 - Euro Plug			
SIZE	DWG NO.	ELECTRONIC FILE	REV
A	M10002424	1717218-1717220_DWG	A
SCALE: NTS		U.O.M.: mm	SHEET: 1 OF 3



PART NO.

SL-19 + SL-6 - Series

REVISIONS

ECN #	REV	DESCRIPTION	DRAWN	DATE	CHECKD	DATE	APPRVD	DATE
-	A	RELEASED	Veena	19/04/10	Jagan	19/04/10	Farnell	03/05/10

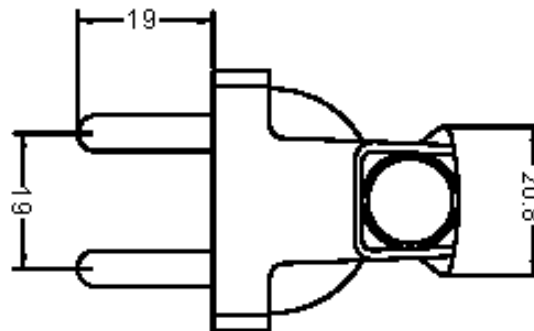
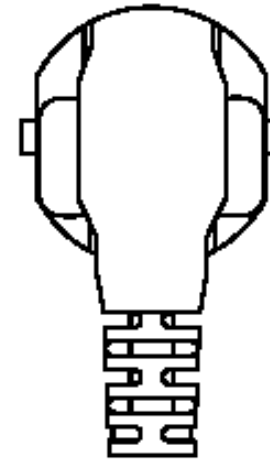
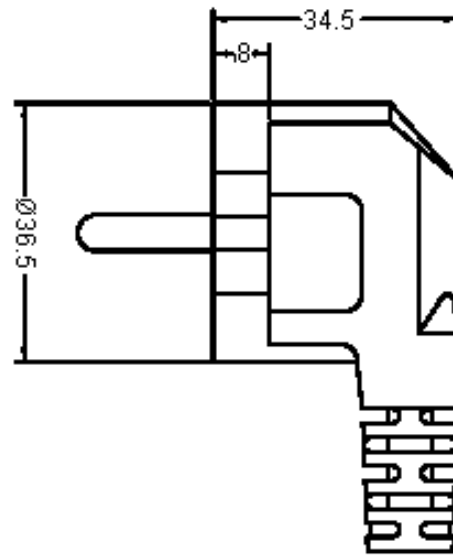
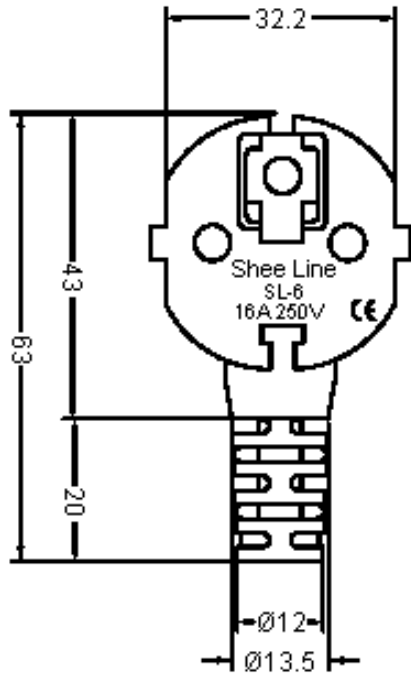

Dimensions: Millimetres

This data sheet and its contents (the "Information") belong to the Premier Farnell Group (the "Group") or are licensed to it. No licence is granted for the use of it other than for information purposes in connection with the products to which it relates. No licence of any intellectual property rights is granted. The Information is subject to change without notice and replaces all data sheets previously supplied. The Information supplied is believed to be accurate but the Group assumes no responsibility for its accuracy or completeness, any error in or omission from it or for any use made of it. Users of this data sheet should check for themselves the Information and the suitability of the products for their purpose and not make any assumptions based on information included or omitted. Liability for loss or damage resulting from any reliance on the Information or use of it (including liability resulting from negligence or where the Group was aware of the possibility of such loss or damage arising) is excluded. This will not operate to limit or restrict the Group's liability for death or personal injury resulting from its negligence. SPC MULTICOMP is the registered trademark of the Group. © Premier Farnell plc 2010.

TOLERANCES:

UNLESS OTHERWISE SPECIFIED, DIMENSIONS ARE FOR REFERENCE PURPOSES ONLY.

DRAWN BY:

Veena

CHECKED BY:

Jagan

APPROVED BY:

Farnell

DATE:

19/04/10

DATE:

19/04/10

DATE:

03/05/10

DRAWING TITLE:

IEC Lead - C19 - Euro Plug

SIZE
A

DWG NO.

M10002424

ELECTRONIC FILE
1717218-1717220_DWG

REV
A

SCALE: NTS

U.O.M.: mm

SHEET: 2 OF 3



PART NO.

SL-19 + SL-6 - Series

REVISIONS

ECN #	REV	DESCRIPTION	DRAWN	DATE	CHECKD	DATE	APPRVD	DATE
-	A	RELEASED	Veena	19/04/10	Jagan	19/04/10	Farnell	03/05/10

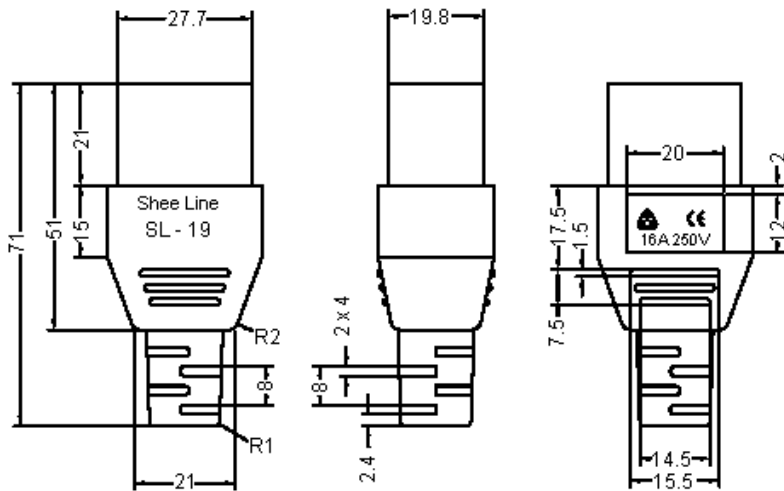
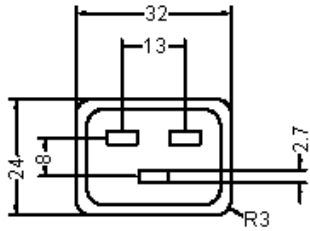

Dimensions: Millimetres

Specifications

Description	Length (L)	Colour	Plug	Connector	Cable	Part Number
Lead, IEC C19 to Euro Plug, 1M	1 M	Black	SL-6 (16A 250V)	SL-19 (16A 250V)	H05VV-F 1.0mm ² /3G	SL-19 + QP026-1
Lead, IEC C19 to Euro Plug, 2M	2 M					SL-19 + QP026-2
Lead, IEC C19 to Euro Plug, 3M	3 M					SL-19 + QP026-3

<http://www.farnell.com>
<http://www.newark.com>
<http://www.cpc.co.uk>

This data sheet and its contents (the "Information") belong to the Premier Farnell Group (the "Group") or are licensed to it. No licence is granted for the use of it other than for information purposes in connection with the products to which it relates. No licence of any intellectual property rights is granted. The Information is subject to change without notice and replaces all data sheets previously supplied. The Information supplied is believed to be accurate but the Group assumes no responsibility for its accuracy or completeness, any error in or omission from it or for any use made of it. Users of this data sheet should check for themselves the Information and the suitability of the products for their purpose and not make any assumptions based on information included or omitted. Liability for loss or damage resulting from any reliance on the Information or use of it (including liability resulting from negligence or where the Group was aware of the possibility of such loss or damage arising) is excluded. This will not operate to limit or restrict the Group's liability for death or personal injury resulting from its negligence. SPC MULTICOMP is the registered trademark of the Group. © Premier Farnell plc 2010.

TOLERANCES:
UNLESS OTHERWISE SPECIFIED, DIMENSIONS ARE FOR REFERENCE PURPOSES ONLY.

DRAWN BY:	DATE:
Veena	19/04/10
CHECKED BY:	DATE:
Jagan	19/04/10
APPROVED BY:	DATE:
Farnell	03/05/10

DRAWING TITLE:

IEC Lead - C19 - Euro Plug

SIZE A	DWG NO. M10002424	ELECTRONIC FILE 1717218-1717220_DWG	REV A
SCALE: NTS		U.O.M.: mm	SHEET: 3 OF 3