

INPUT RECTIFIER DIODE Lead-Free ("PbF" suffix)

Description/ Features

The 20ETS...SPbF rectifier *SAFEIR* series has been optimized for very low forward voltage drop, with moderate leakage. The glass passivation technology used has reliable operation up to 150°C junction temperature.

Typical applications are in input rectification and these products are designed to be used with International Rectifier Switches and Output Rectifiers which are available in identical package outlines.

	$V_F < 1V @ 10A$ $I_{FSM} = 300A$ $V_{RRM} = 800 - 1200V$
---	---

Output Current in Typical Applications

	Single-phase Bridge	Three-phase Bridge	Units
Capacitive input filter $T_A = 55^\circ C$, $T_J = 125^\circ C$, common heatsink of $1^\circ C/W$	16.3	21	A

Major Ratings and Characteristics

Characteristics	Values	Units
$I_{F(AV)}$ Sinusoidal waveform	20	A
V_{RRM}	800 to 1200	V
I_{FSM}	300	A
V_F @ 10A, $T_J = 25^\circ C$	1.0	V
T_J	-40 to 150	$^\circ C$

Package Outline



Voltage Ratings

Part Number	V_{RRM} , maximum peak reverse voltage V	V_{RSM} , maximum non repetitive peak reverse voltage V	I_{RRM} 150°C mA
20ETS08SPbF	800	900	1
20ETS10SPbF	1000	1100	1
20ETS12SPbF	1200	1300	1

Absolute Maximum Ratings

Parameters	20ETS..	Units	Conditions
$I_{F(AV)}$ Max. Average Forward Current	20	A	@ $T_C = 105^\circ\text{C}$, 180° conduction half sine wave
I_{FSM} Max. Peak One Cycle Non-Repetitive Surge Current	250	A	10ms Sine pulse, rated V_{RRM} applied
	300		10ms Sine pulse, no voltage reapplied
I^2t Max. I^2t for fusing	316	A^2s	10ms Sine pulse, rated V_{RRM} applied
	442		10ms Sine pulse, no voltage reapplied
$I^2\sqrt{t}$ Max. $I^2\sqrt{t}$ for fusing	4420	$A^2\sqrt{s}$	t = 0.1 to 10ms, no voltage reapplied

Electrical Specifications

Parameters	20ETS..	Units	Conditions
V_{FM} Max. Forward Voltage Drop	1.1	V	@ 20A, $T_J = 25^\circ\text{C}$
r_t Forward slope resistance	10.4	mΩ	$T_J = 150^\circ\text{C}$
$V_{F(TO)}$ Threshold voltage	0.85	V	
I_{RM} Max. Reverse Leakage Current	0.1	mA	$T_J = 25^\circ\text{C}$
	1.0		$T_J = 150^\circ\text{C}$

$V_R = \text{rated } V_{RRM}$

Thermal-Mechanical Specifications

Parameters	20ETS..	Units	Conditions
T_J Max. Junction Temperature Range	-40 to 150	°C	
T_{stg} Max. Storage Temperature Range	-40 to 150	°C	
R_{thJC} Max. Thermal Resistance Junction to Case	1.3	°C/W	DC operation
R_{thJA} Max. Thermal Resistance Junction to Ambient	62	°C/W	(*) For D ² Pak version
R_{thCS} Typ. Thermal Resistance Case to Heatsink	0.5	°C/W	Mounting surface, smooth and greased
wt Approximate Weight	2 (0.07)	g (oz.)	
T Mounting Torque	Min.	6 (5)	Kg-cm (lbf-in)
	Max.	12 (10)	
Case Style	D ² Pak (SMD-220)		

* When mounted on 1" square (650mm²) PCB of FR-4 or G-10 material 4 oz (140μm) copper 40°C/W
For recommended footprint and soldering techniques refer to application note #AN-994

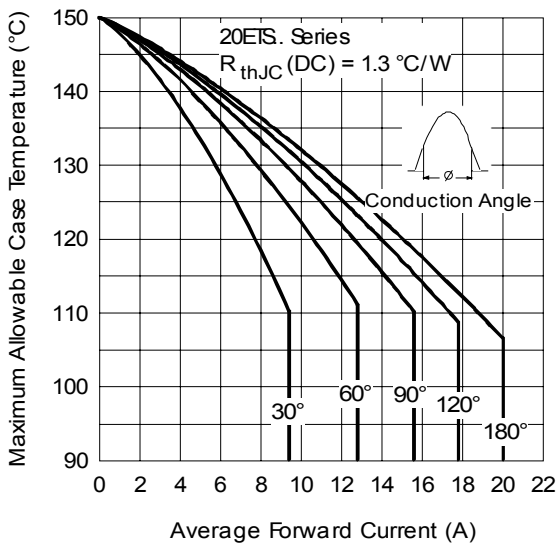

Fig. 1 - Current Rating Characteristics

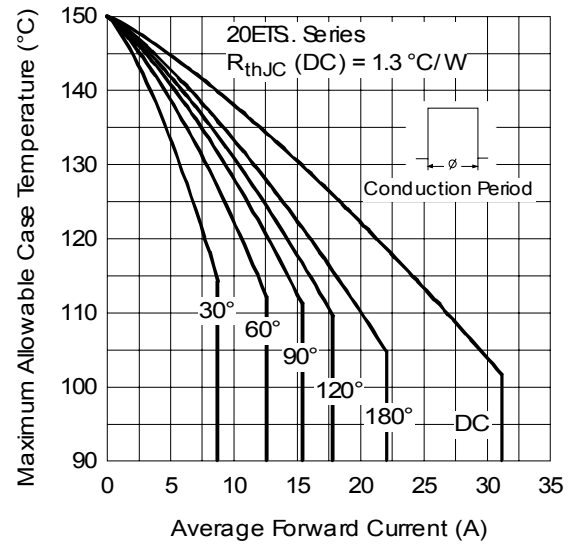

Fig. 2 - Current Rating Characteristics

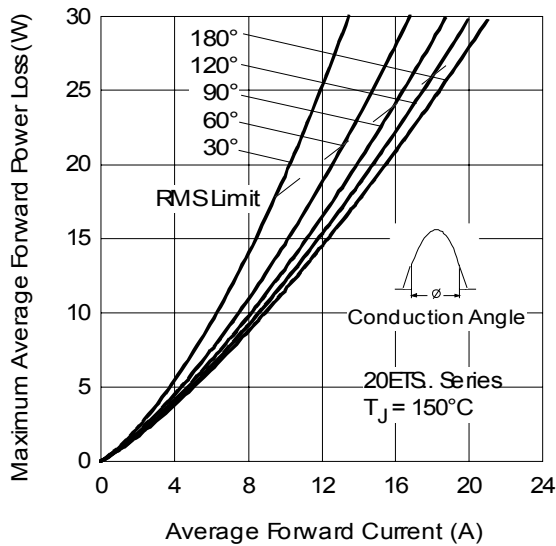

Fig. 3 - Forward Power Loss Characteristics

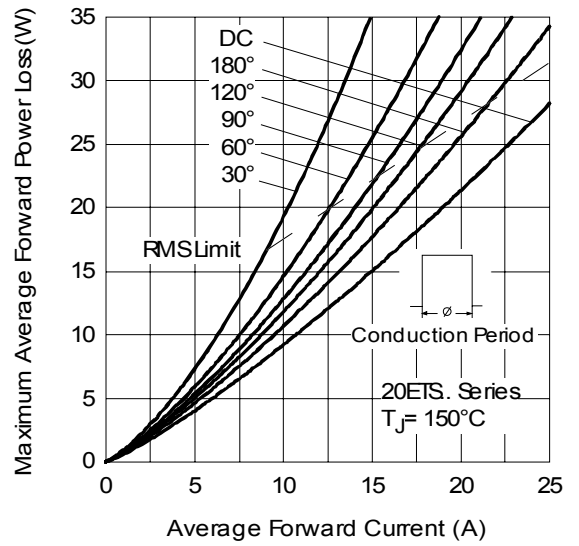

Fig. 4 - Forward Power Loss Characteristics

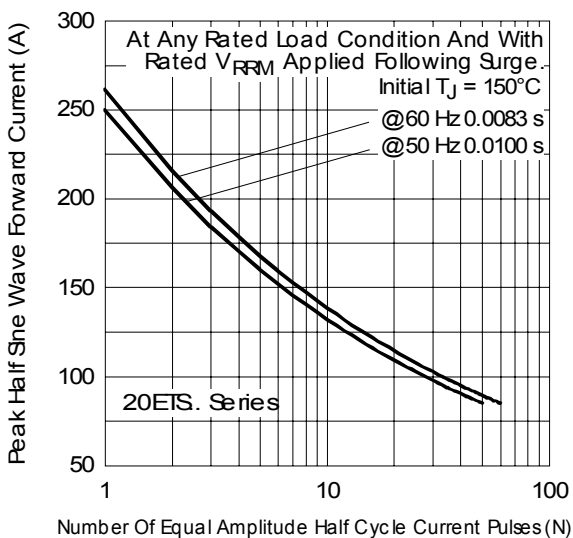

Fig. 5 - Maximum Non-Repetitive Surge Current

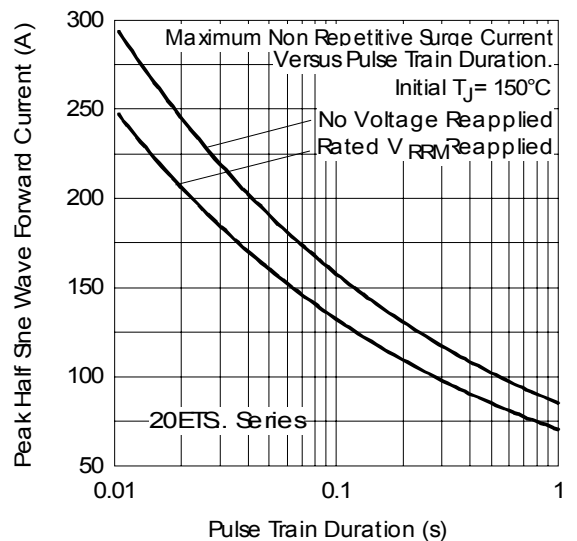

Fig. 6 - Maximum Non-Repetitive Surge Current

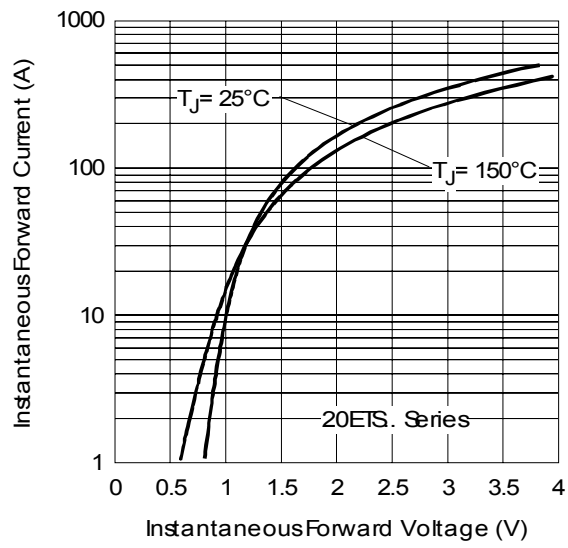

Fig. 7 - Forward Voltage Drop Characteristics

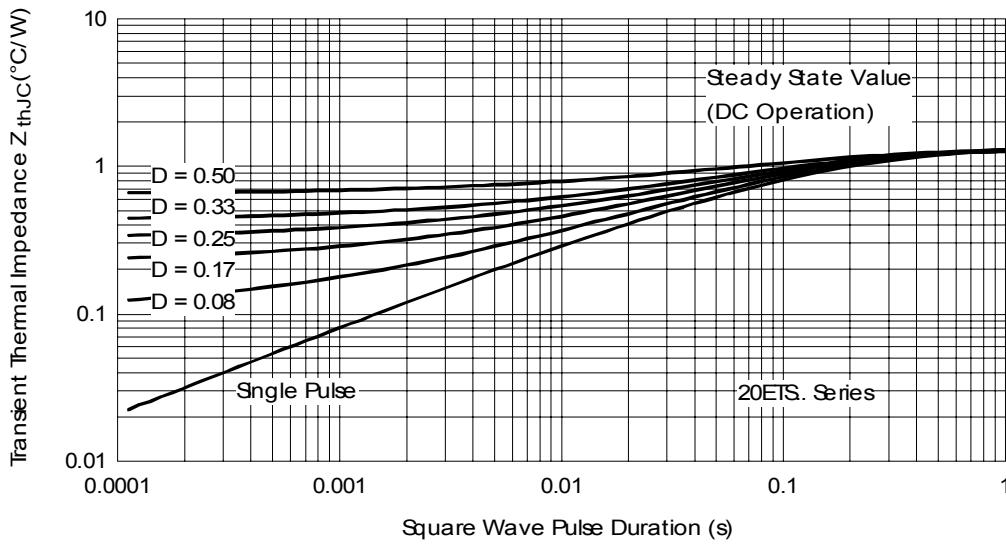
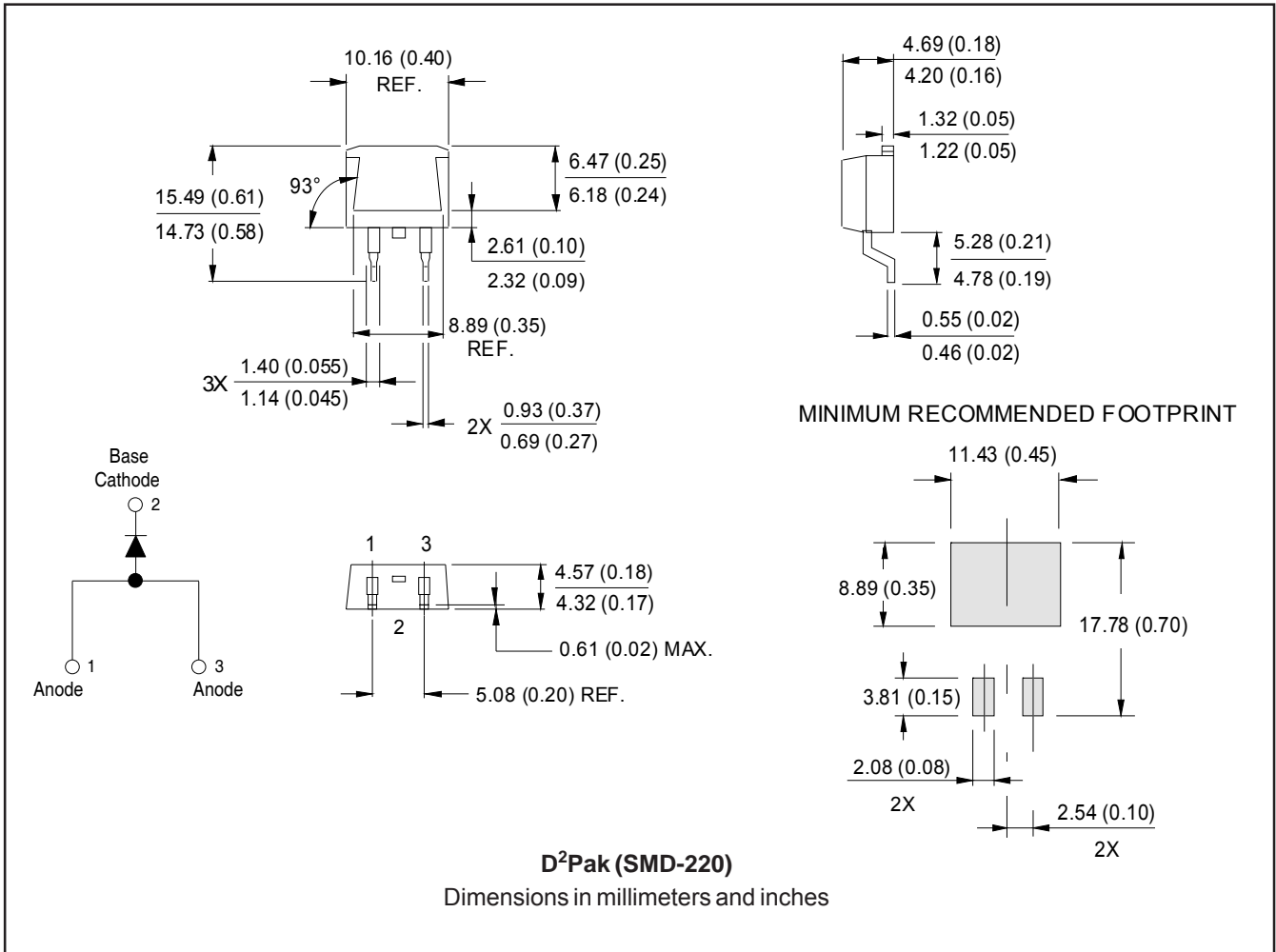
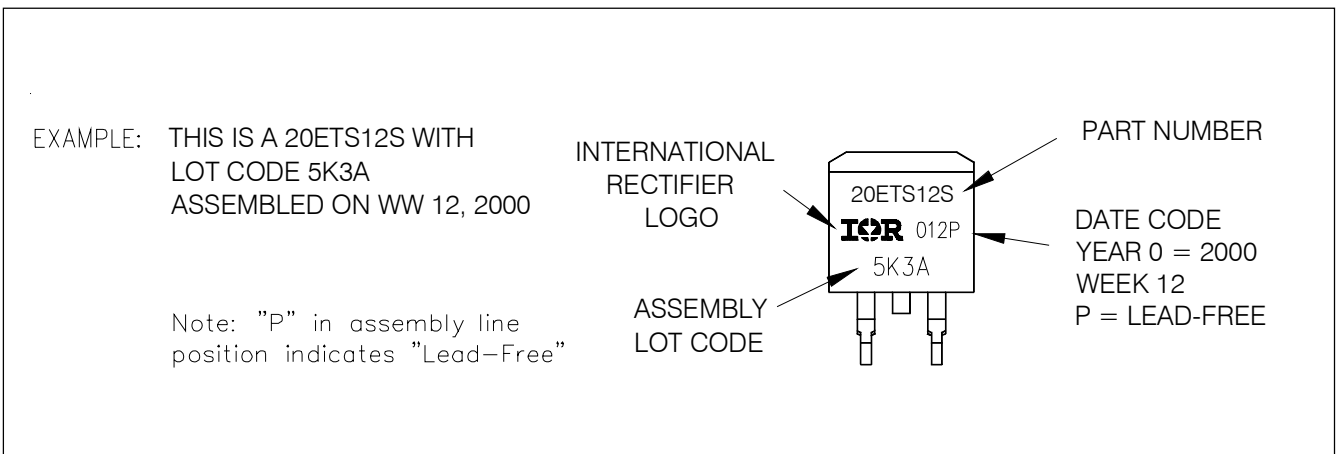

Fig. 8 - Thermal Impedance Z_{thJC} Characteristics

Outline Table



Marking Information



Ordering Information Table

Device Code							
20	E	T	S	12	S	TR	PbF
1	2	3	4	5	6	7	8
1	-	Current Rating (20 = 20A)					
2	-	Circuit Configuration					
		E = Single Diode					
3	-	Package					
		T = TO-220AC					
4	-	Type of Silicon					
		S = Standard Recovery Rectifier					
5	-	Voltage Code X 100 = V_{RRM}					
6	-	S = TO-220 D ² Pak (SMD-220) Version					
7	-	<ul style="list-style-type: none"> • none = Tube • TRL = Tape & Reel (Left Oriented) • TRR = Tape & Reel (Right Oriented) 					
8	-	<ul style="list-style-type: none"> • none = Standard Production • PbF = Lead-Free 					

08 = 800 V
 10 = 1000 V
 12 = 1200 V

Data and specifications subject to change without notice.
 This product has been designed and qualified for Industrial Level and Lead-Free.
 Qualification Standards can be found on IR's Web site.