

Klockner **MOELLER**



175-341 to 175-352
176-593, 176-594
178-698, 178-699

PKZM 1 Manual Motor Starters

Devices
for world
markets

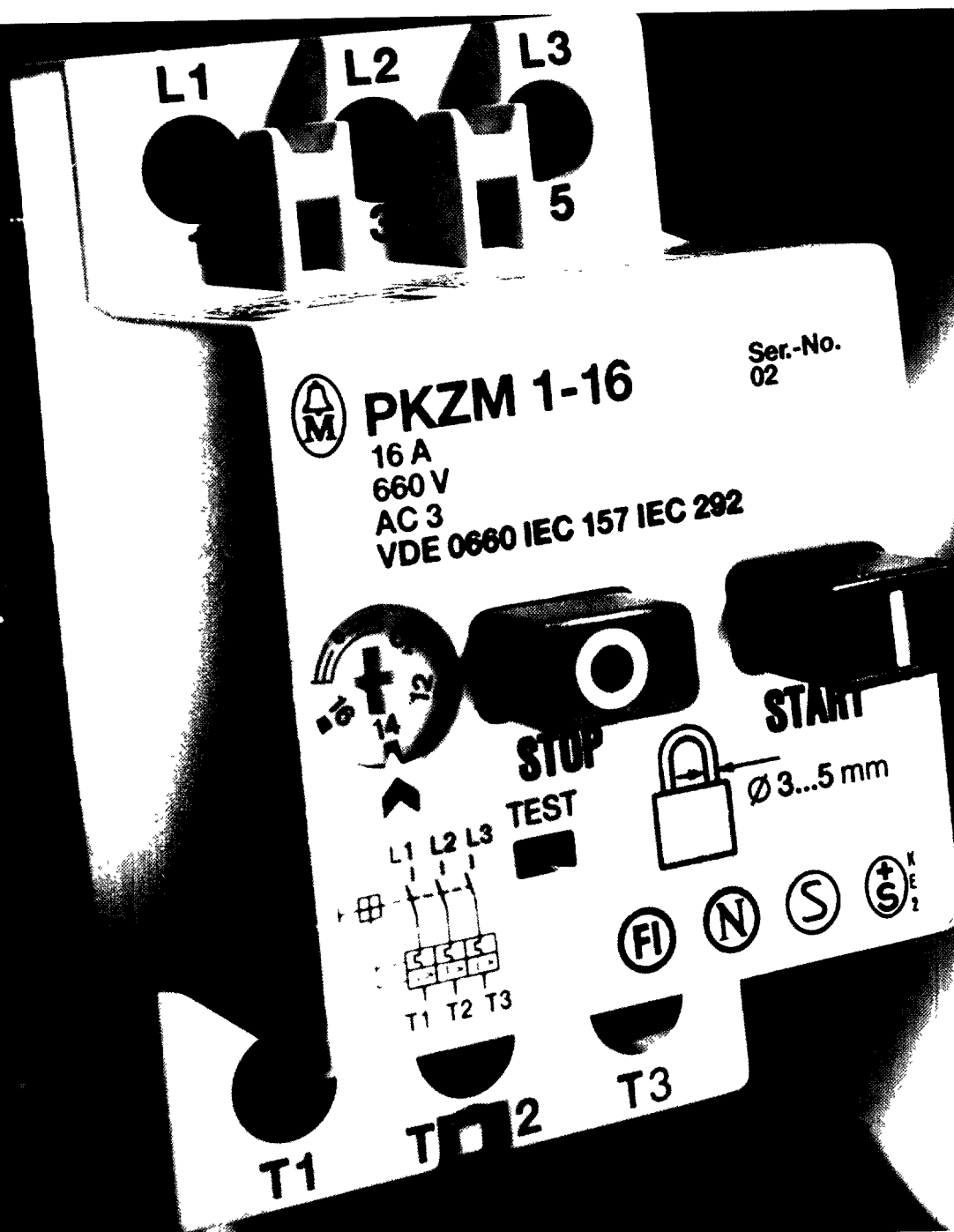

PKZM 1 Approvals – the Passport to Int



International Success

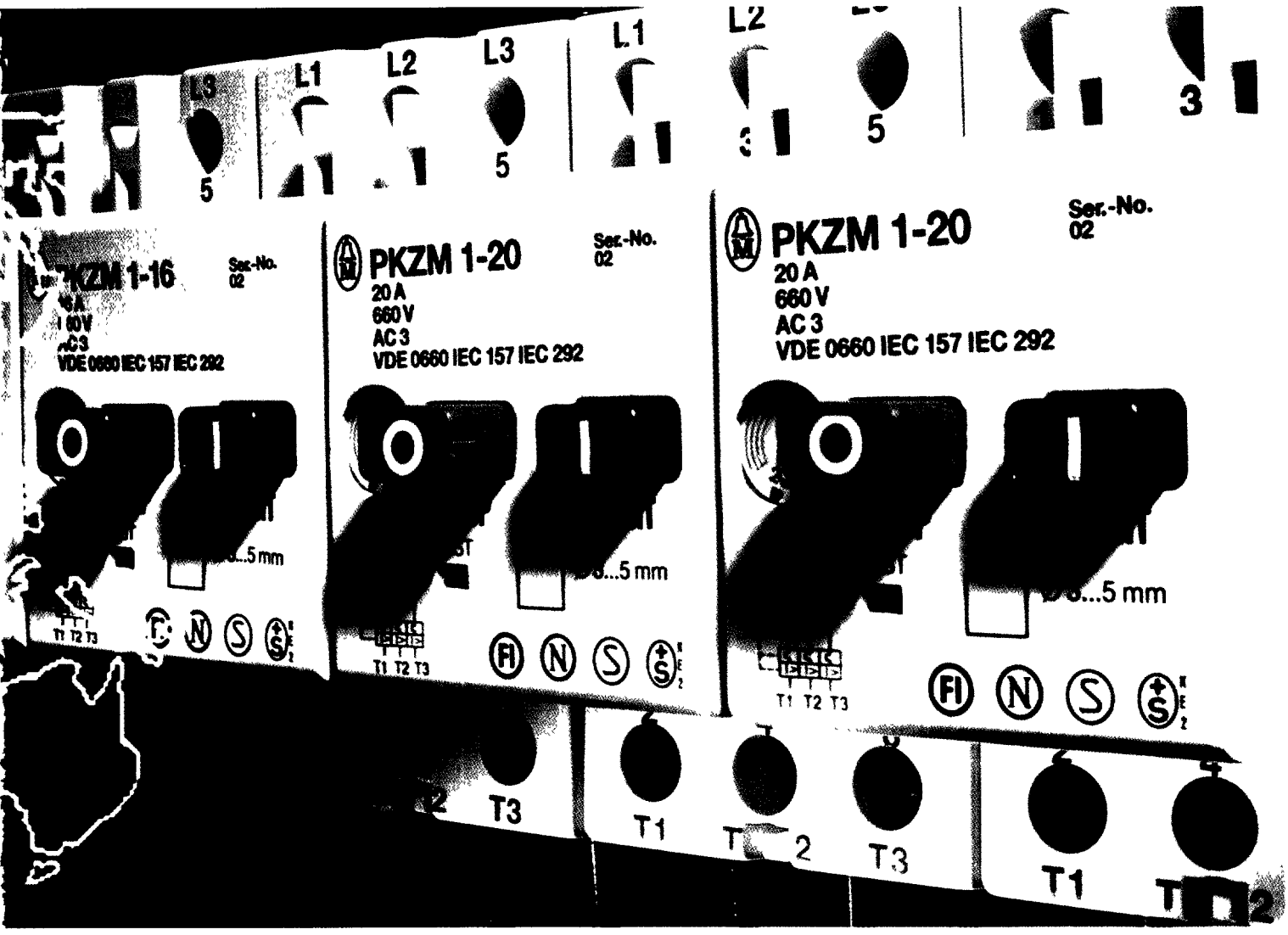

Devices for world markets

such as Klockner-Moeller's PKZM 1 manual motor starters can be used all over the world. They have approvals covering all countries and are given approval marks during manufacture.

Flexible design and reliability – into the future.

For national and international companies – the PKZM 1 manual motor starter provides an excellent basis for operational reliability.



PKZM 1 – The System for Optimum So

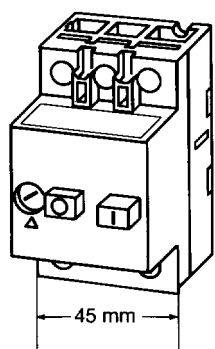
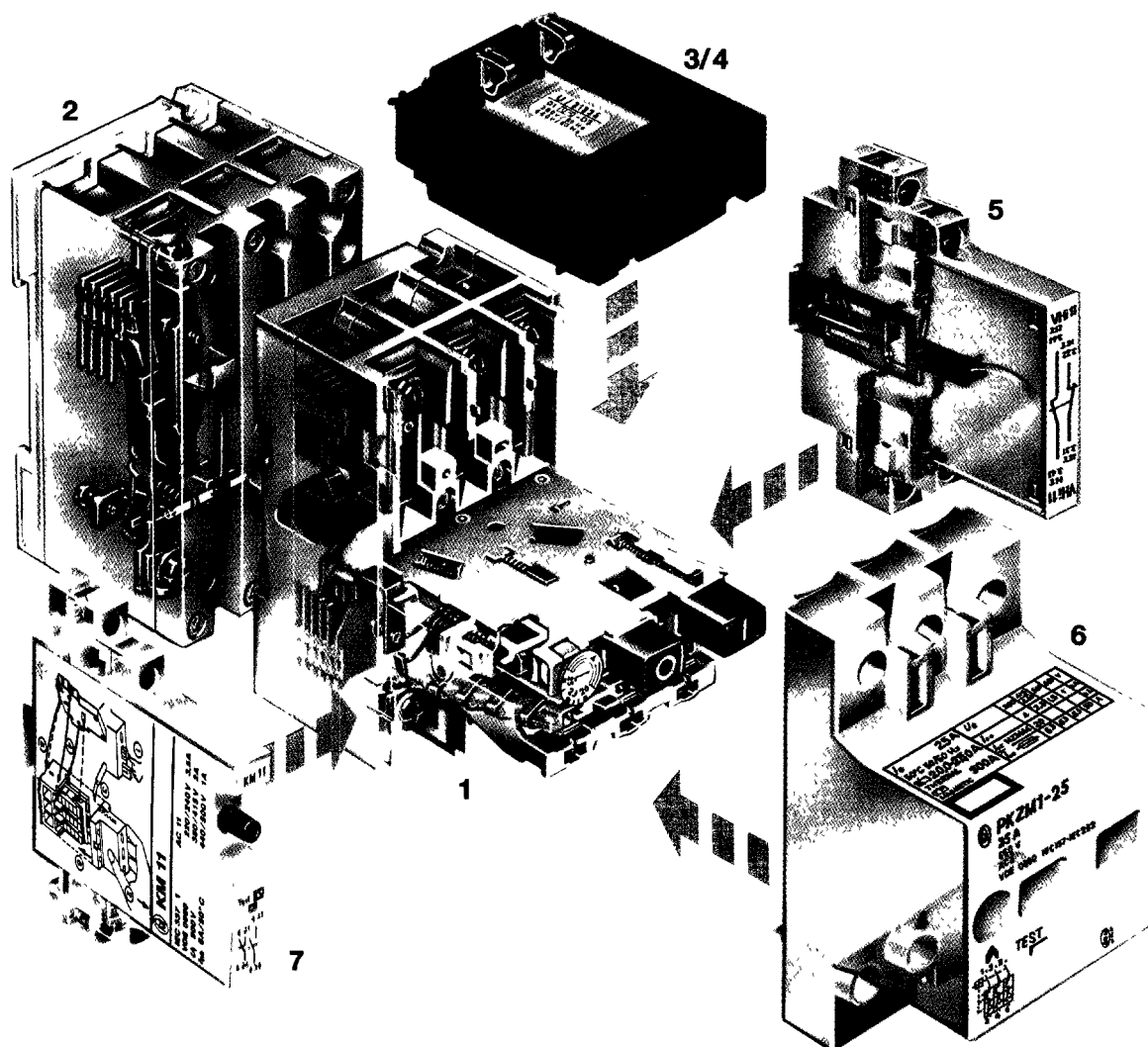

PKZM 1 dimensions to EN 4380
 $a = 2\frac{1}{2}$ times the width of a miniature circuit-breaker (17.5 mm)

1
Protective module
PKZM 1 manual motor starter
 With single-phasing sensitivity to IEC 292

2
CL-PKZM 1 current limiter
 To increase switching capacity up to 50 kA at 380 V

3
Voltage release
 As a) undervoltage release or b) shunt release

4
Trip-indicating auxiliary contacts
 For trip indication

5
Auxiliary contacts
 For indication of operational states and for visual or audible signals; can be fitted on both sides of the PKZM 1

6
Shroud
 With rating labels for application worldwide (including Canada and USA)

7
Short-circuit indicator
 For clear fault indication

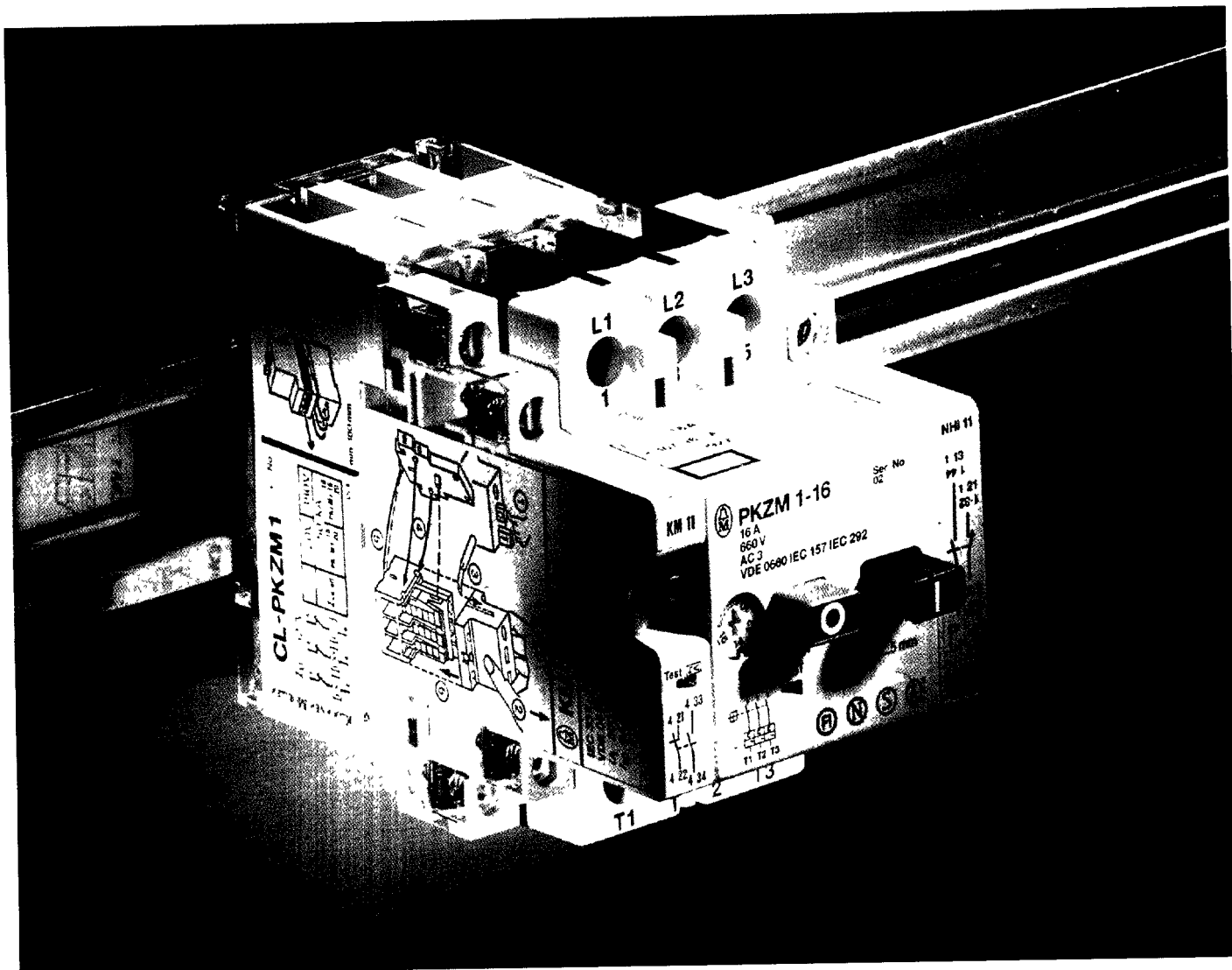

Over 50 years of experience have gone into this protective switch

The PKZM 1 system provides effective motor protection.

- In the event of an overload
Reliable protection of motors, cables, etc. by means of thermally delayed overload releases.
Disconnection in all poles.
- In the event of short-circuits
Effective protection by means of current-limiting contact system with instantaneous short-circuit releases.
Disconnection in all poles.

The cap dimensions and compact construction of the PKZM 1 make for straightforward mounting (e.g. alongside miniature circuit-breakers).

All versions of the PKZM 1 can, of course, be fitted in individual enclosures, or in control panels and distribution boards.

A large number of accessories permits cost-effective realization of standard and more specialized applications.

PKZM 1 Basic Device – More than Just

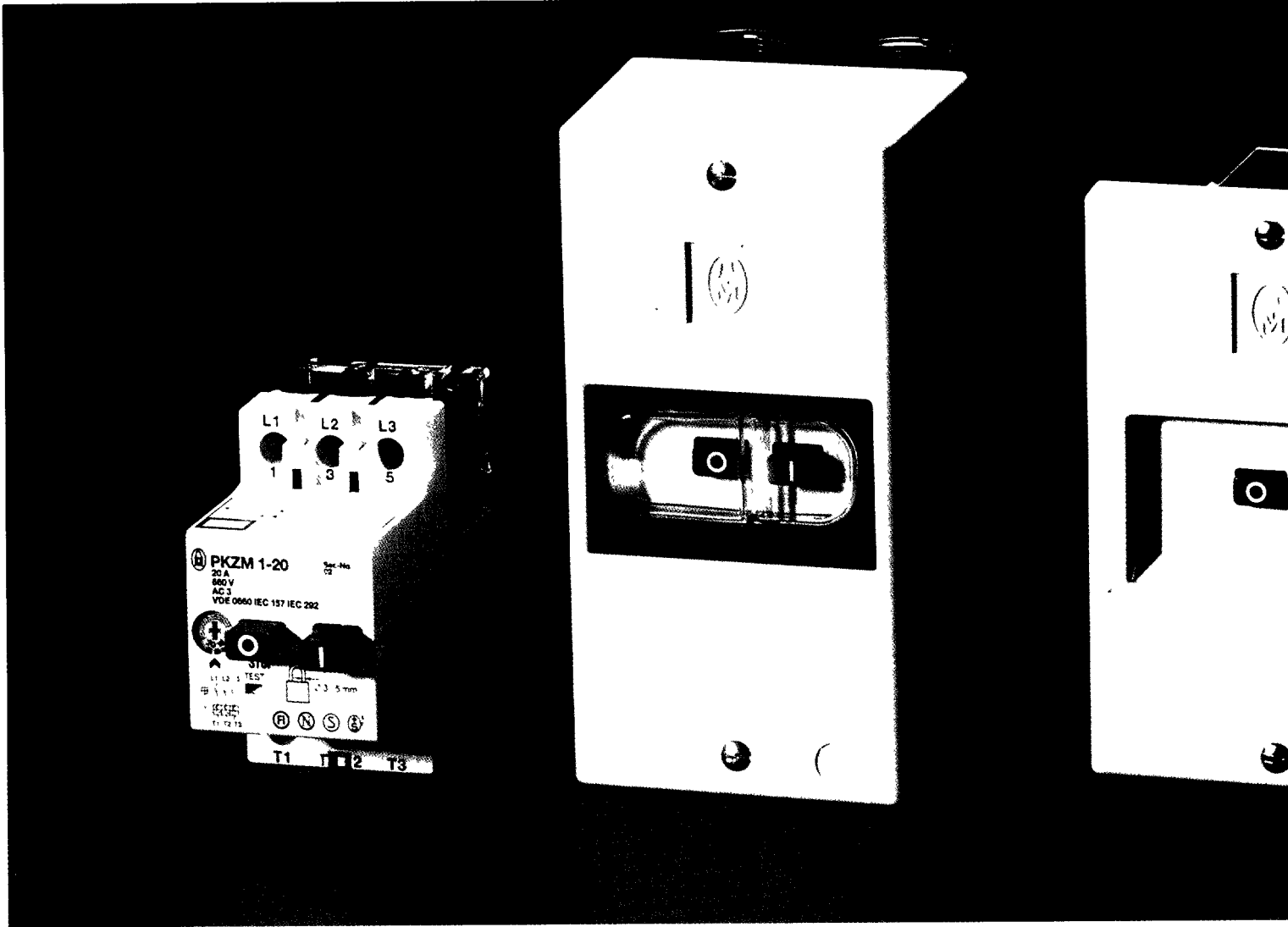

The PKZM 1 basic module:

- The operational state is clearly indicated by the dual push-button system (even with mechanically blocked contacts)
- Single-phasing sensitivity (to IEC 292-1)
 - Important for EExe explosion-proofed motors
- Temperature compensated overload releases from -5°C to $+40^{\circ}\text{C}$ (IEC 292-1) guarantee high tripping accuracy
- Test facility (checks switching operation and trip-indicating auxiliary contacts)

- Can be fitted into distribution boards and control panels with no need for any further protection against direct contact
- High mechanical shock resistance
 - Many possible applications
- Excellent connection facilities
 - Open terminals
 - Wire entry guide
 - Screwdriver guide
 - Self-clamping terminals on voltage releases and trip-indicating auxiliary contacts
- Snap-on fit on top-hat rail (35 mm), or optional screw fitting
- IP 20 degree of protection (includes protection against direct contact to VDE 0106 Part 100)
- Standardized cap dimensions and compact design permit mounting in service distribution boards

1
PKZM 1 basic unit

2
Surface-mounting enclosure
For mounting on walls, machines, etc.

3
Flush-mounting enclosure
For fitting in cavities

4
Rear-mounting enclosure
For fitting in control panels, for example

One Step Ahead

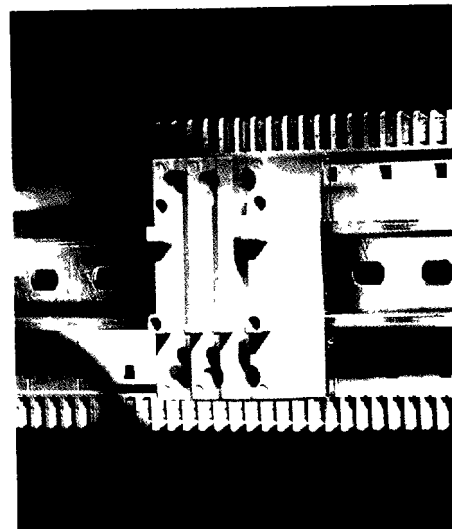
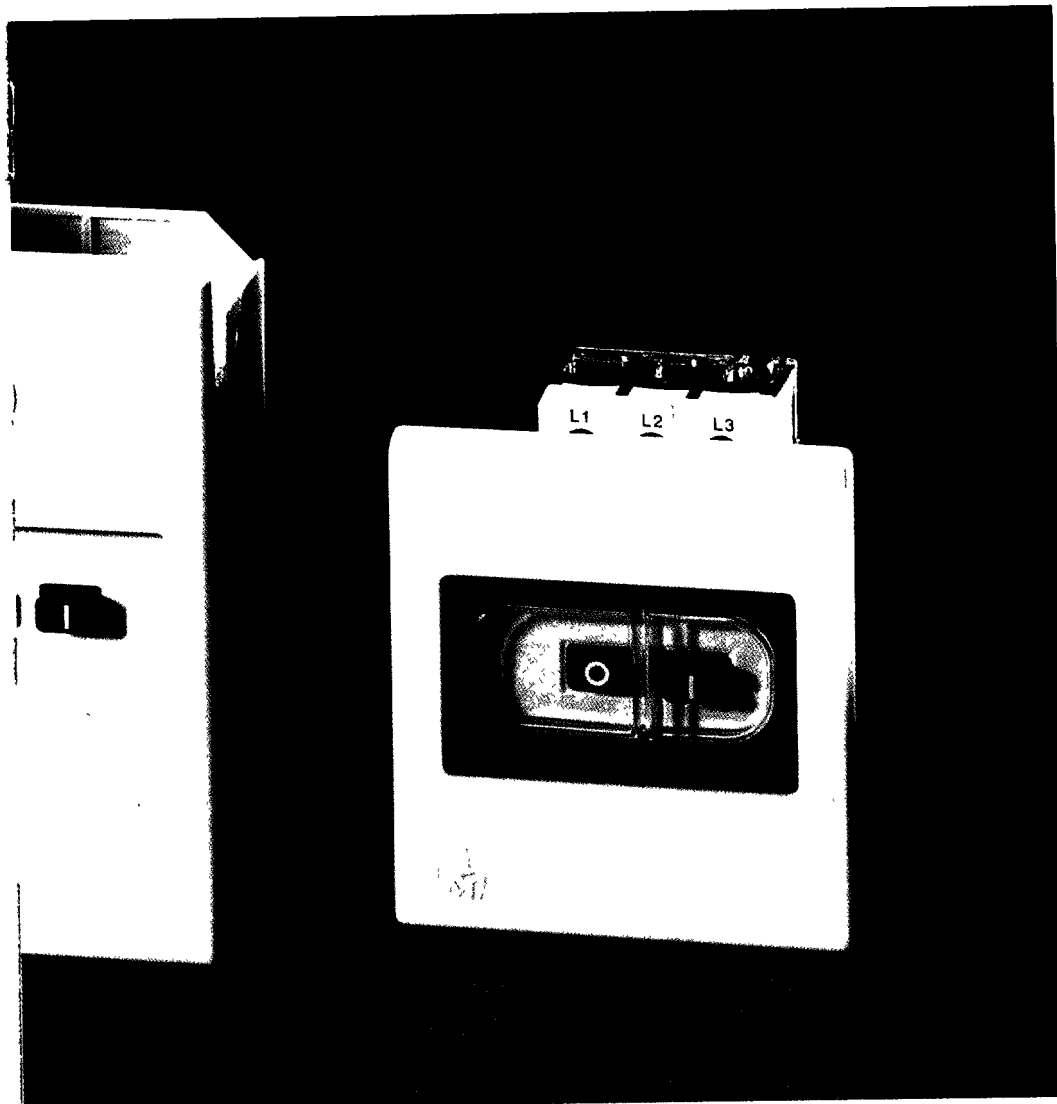

5

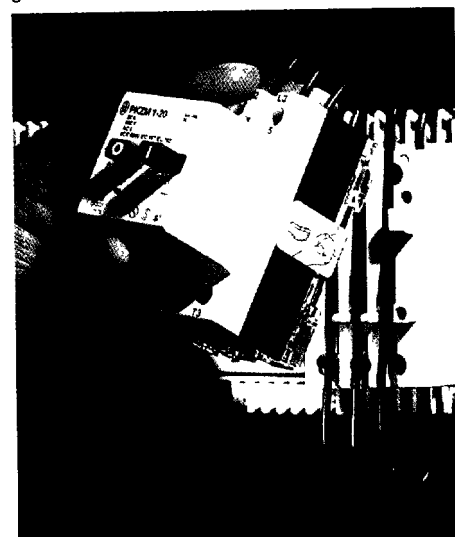

6

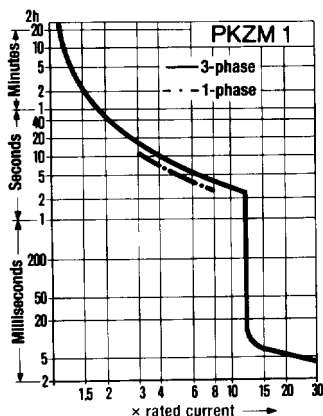

The characteristic curve shows the tripping time of the starter in relation to the operating current. Mean values of tolerance bands at 20°C ambient temperature from a cold start. At operational temperature, the tripping time of the overload releases is approximately 1/4 of that stated.

CL-PKZM 1 current limiter

5

The CL-PKZM 1 current limiter, with its three independently operating repulsion contacts, is connected in series with the main contacts of the PKZM 1. In the event of a short-circuit, both contact systems open, with the PKZM 1 providing maintained isolation. The contacts of the current limiter close again.

- High switching capacity PKZM 1 + CL: up to 50 kA at 380 V (results from the rapid current-limiting action in the CL module and the reduction in arcing time caused by the additional isolating clearance during the arcing phase).

- Used in three-phase systems, when the rated making capacity I_{cn} of the PKZM 1 is lower than the prospective short-circuit current I_{cc}

- Three-phase commoning links for grouping of incoming supplies

- Can be clipped onto a top-hat rail or screwed directly onto a mounting plate by means of the integral screw fixing

- Simple wiring and snap-fitting of the PKZM 1

- Finger-proof terminals; the wiring from the CL to the PKZM 1 is led through channels, which helps to save space (Figure 6)

PKZM 1 – Clearly More Information

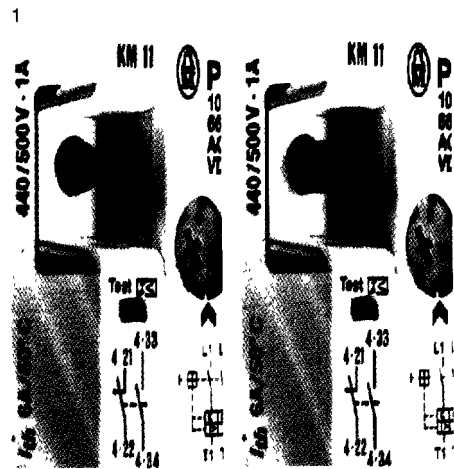
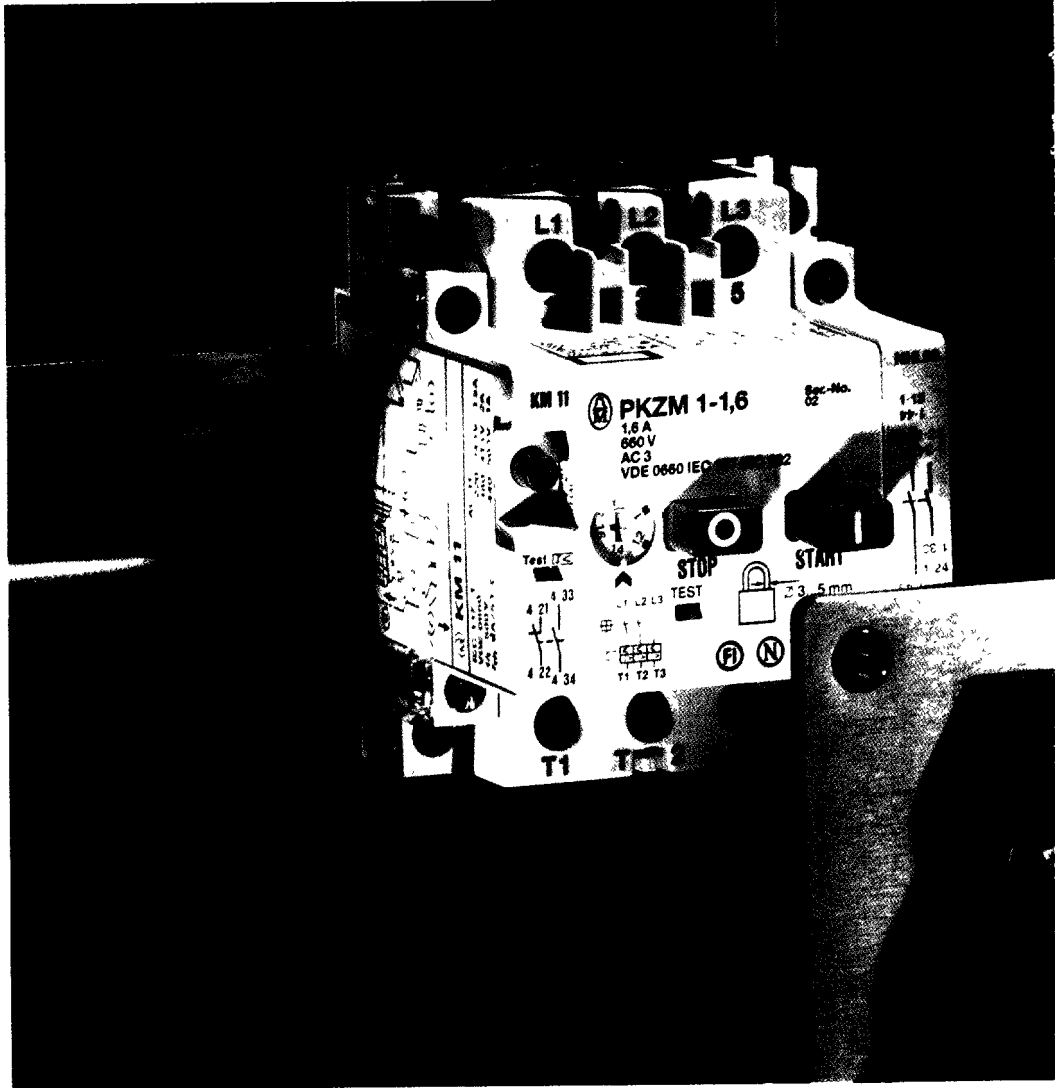
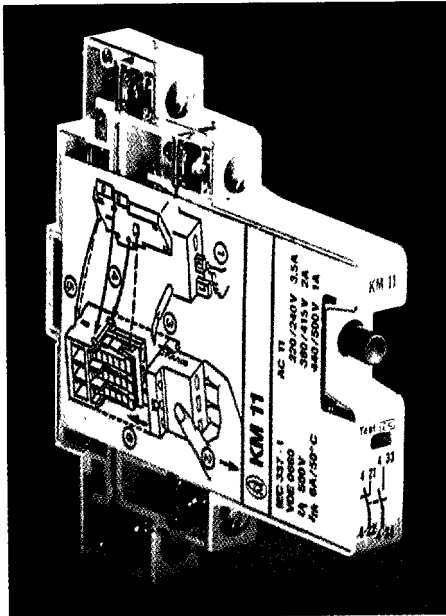

1 Convenience through clear indication

The PKZM 1 shows the operational state, indicates the tripped condition and quickly provides information on the cause for tripping. Short-circuit indications can now be given locally as well as remotely.

- 2
- The operational state is clearly indicated by the dual push-button system (with test facility)
 - Auxiliary contact modules, indicator lights and trip-indicating auxiliary contacts show the operational state or the tripped condition both locally and centrally by means of visual signals
 - The cause is indicated in the central control room
 - Quick local identification of the cause is also available now: the KM11 PKZM 1 short-circuit indicator indicates the short-circuit on the protective switch (with test facilities and manual reset)

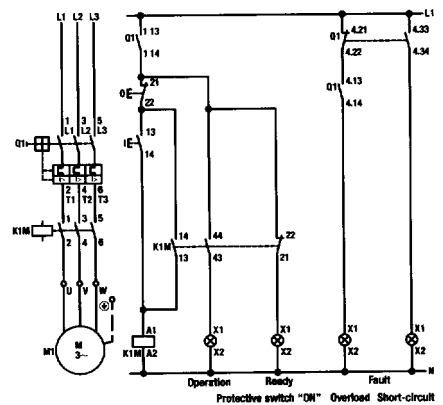

PKZM 1 with undervoltage release supplied via VHi early-make auxiliary contact, and with visual indication of operational and tripped states.

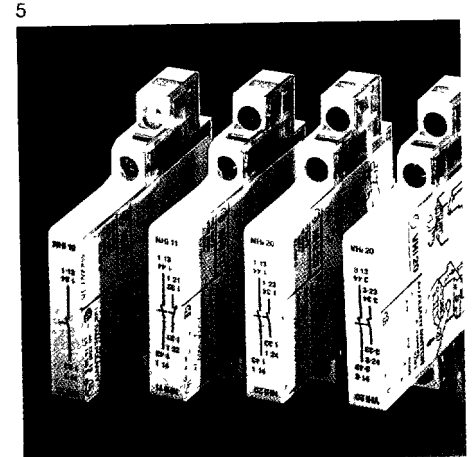
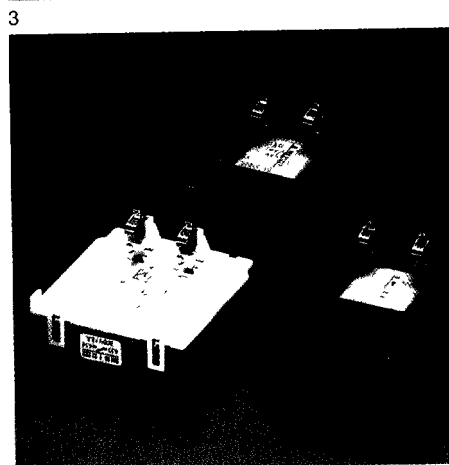
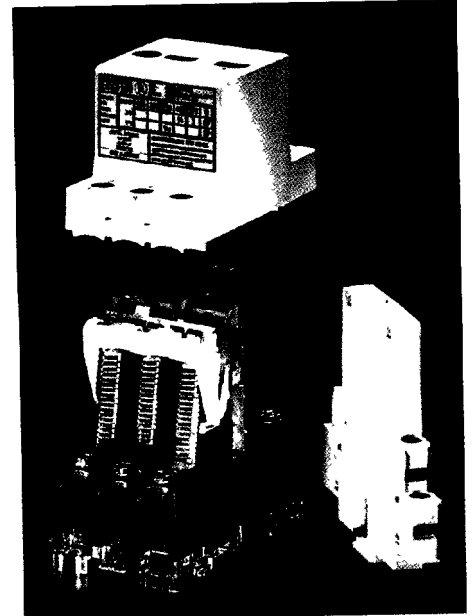
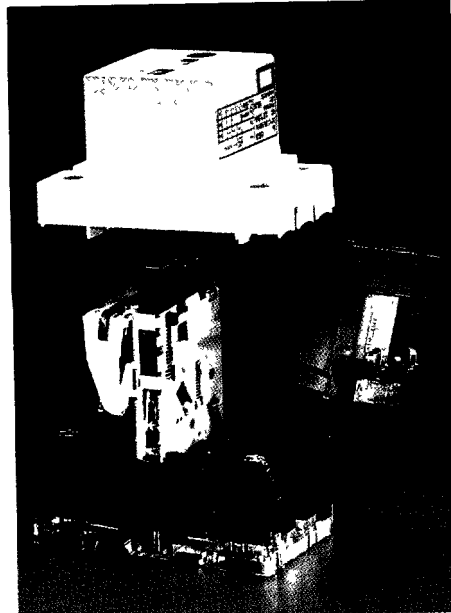
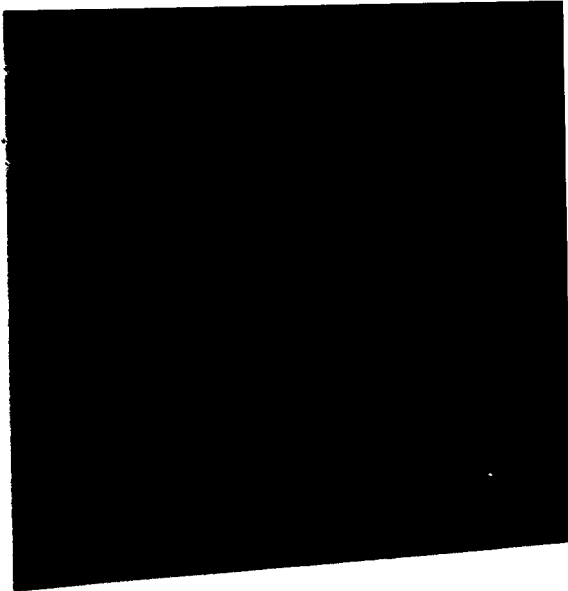

Push- and latch-feature.
The simple system
for the PKZM 1
and all components.

4

3

Releases/indicators

- Remove shroud
- Slide module onto guide-rail at the bottom
- Latch module into position at the top
- Replace shroud

4

Releases/indicators

For fitting under the shroud of the PKZM1 basic device

U-PKZM 1 undervoltage release

Designed for 100% DF

A-PKZM 1 shunt release

Designed for 100% DF

RHi 10/RHi 01 trip-indicating auxiliary contacts

For trip indication

6

5

Auxiliary contact units

- Remove shroud
- Push lugs of the auxiliary contact unit into openings at the sides of the PKZM 1
- Latch in auxiliary contact
- Replace shroud

A maximum of two auxiliary contact units (six contacts) can be fitted in the PKZM 1; these can be fitted on either side.

6

Auxiliary contacts

For fitting on either side of the PKZM 1 enclosure

NHi

For indication of operational states

VHi

For indication of visual and audible signals

PKZM 1 – For Safety's Sake

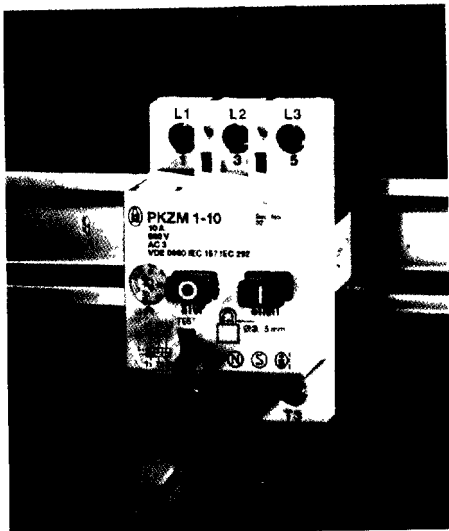

1

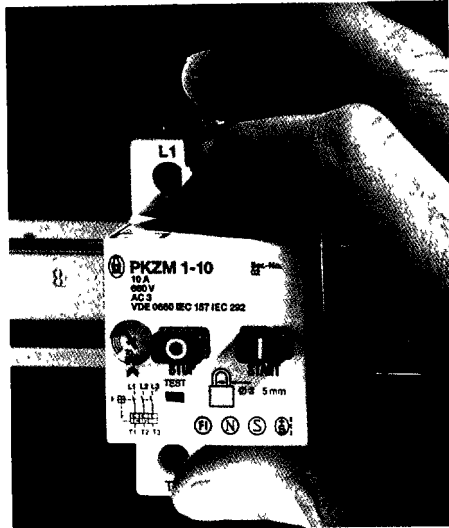

2

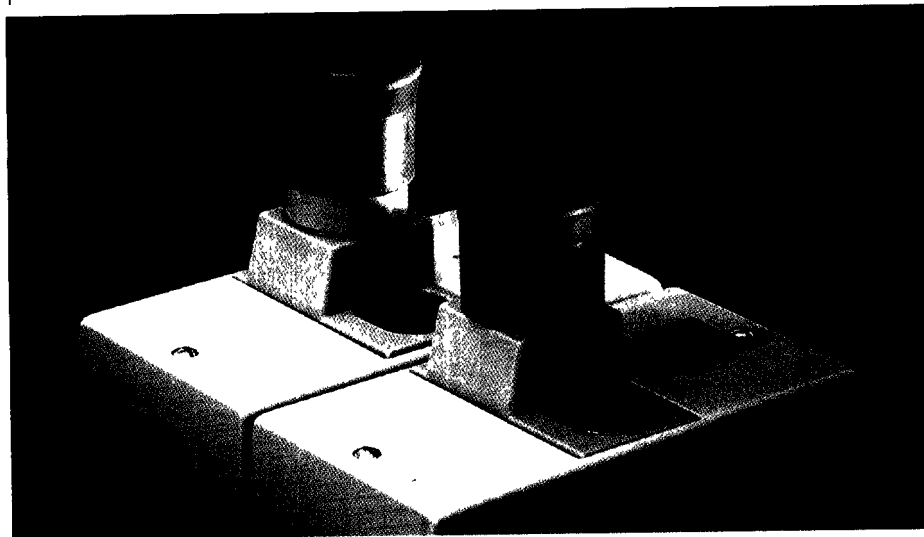

3



1
The switch mechanism can be tripped mechanically to test the operation of the trip-indicating auxiliary contact

2
Protection against direct contact to VBG 4

- a) Finger-proof area
- b) Back-of-hand-proof area

3
The latched mushroom button must be released intentionally before it can be reset (motor protection and emergency-stop)

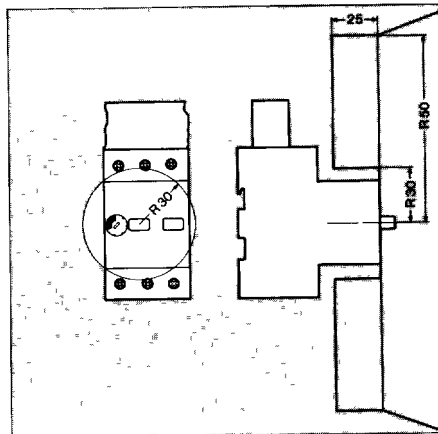

VDE 0106 Part 100 specifies a finger-proof area of 30 mm radius around a push-button. The PKZM 1 provides more. With IP 20 degree of protection, the PKZM 1 offers safety all-round to IEC test fingers. This means more safety for the user

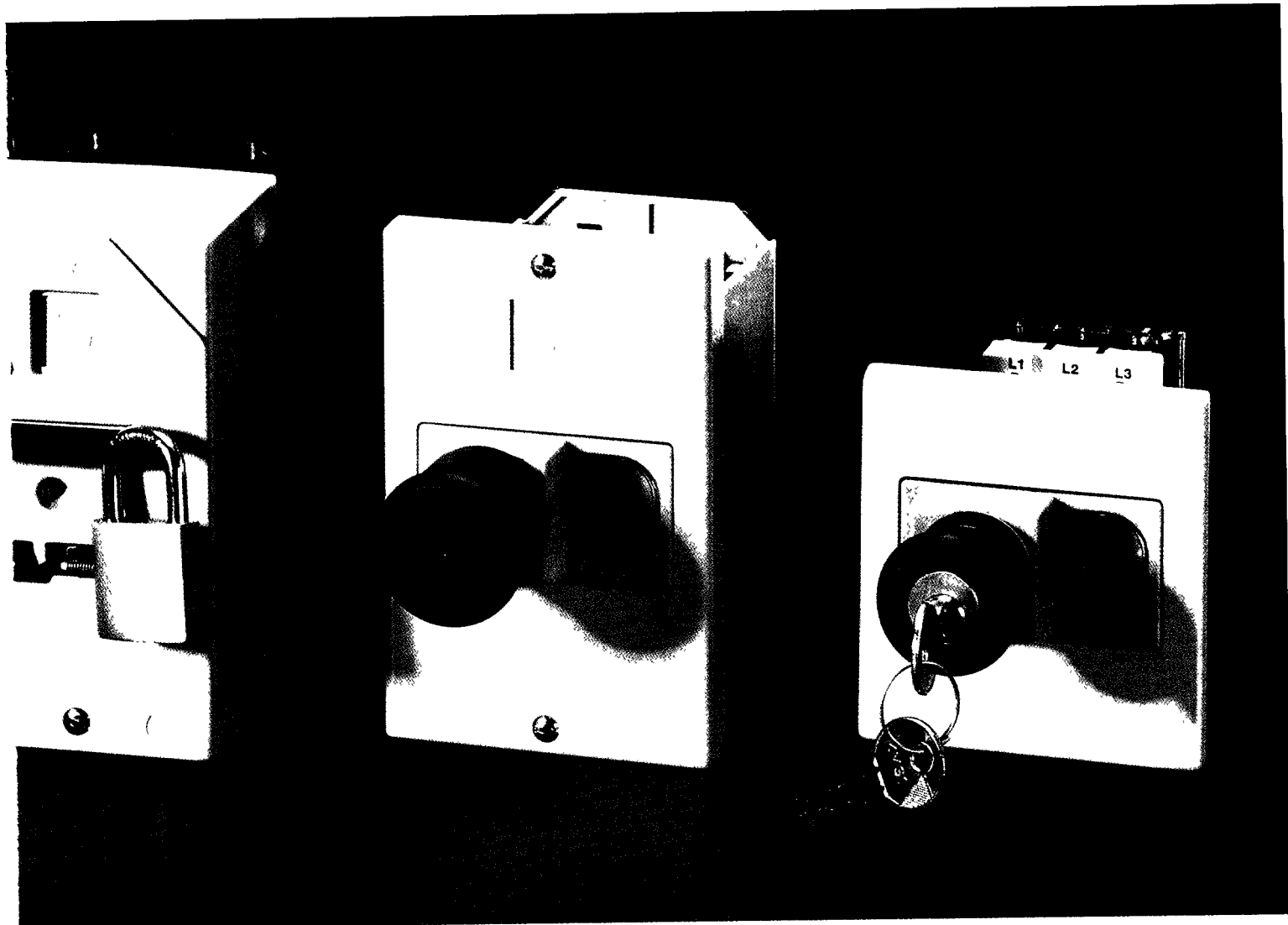

Safely locked up:

4

Securing the "Off position"

By fitting a padlock directly onto the button system.

5

Main switch

Conforming to IEC 204-1
Isolating characteristics to IEC 408. Off position can be locked by fitting a padlock (to enclosure).

6/7

Emergency-stop device

Conforming to IEC 204-1. Stopping by means of emergency-stop button in case of danger. The mushroom button latches in and can be released by pulling or by means of a key.

PKZM 1 – Every Option with Simple Ins

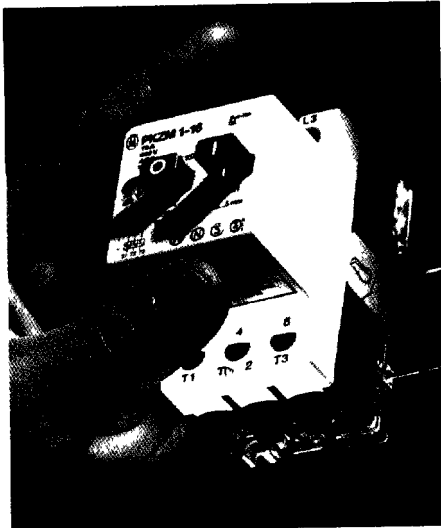

1

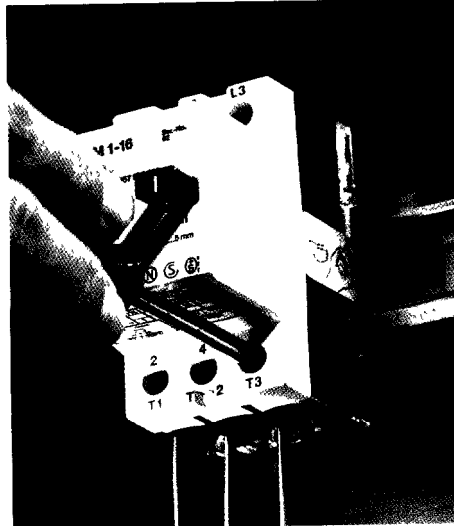

2

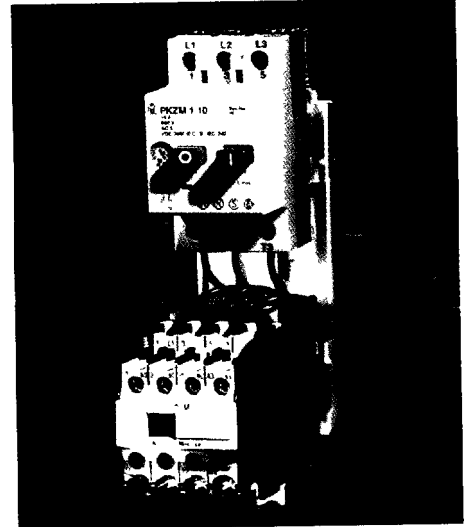

3

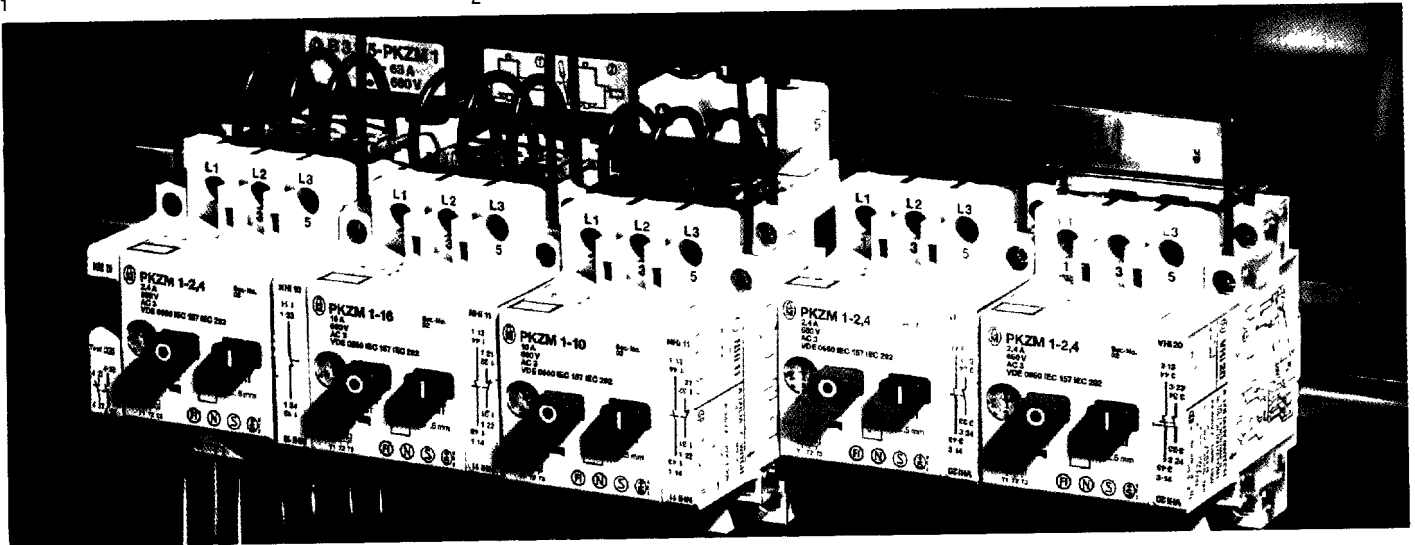

4

1 Clip-on or screw fixing – it's up to you

- a) Clip-on technique for mounting onto top-hat rail
- b) Integral screw fixing, for fixing to mounting plate

2

Sound connection guaranteed:

Wire entry guides and open screw terminals make for quick wiring

- a) Entry guide = screwdriver guide
- b) Open screw terminals; clamping washers have collars to prevent wires pulling out

3

Motor starter combinations

The main circuits are pre-wired. The combination is a snap-on fit on top-hat rails to EN 50022-35, but, using a busbar adapter, it can also be fitted directly onto busbars.

4

B3-PKZM 1 three-phase commoning link

The incoming supplies of several PKZM 1 manual motor starters can be connected as a group using this busbar link. Ready-cut links (for four PKZM 1 or five PKZM 1) reduce the wiring and fitting time for switchgear assemblies and control panels to a minimum.

- The incoming supply can be connected at any point and does not take up any additional space.

- The entire commoning link can be removed without being dismantled, as the end covers on the commoning link prevent the terminal lugs from being inserted too far.

- The commoning link and incoming terminal are reliably protected against direct contact.

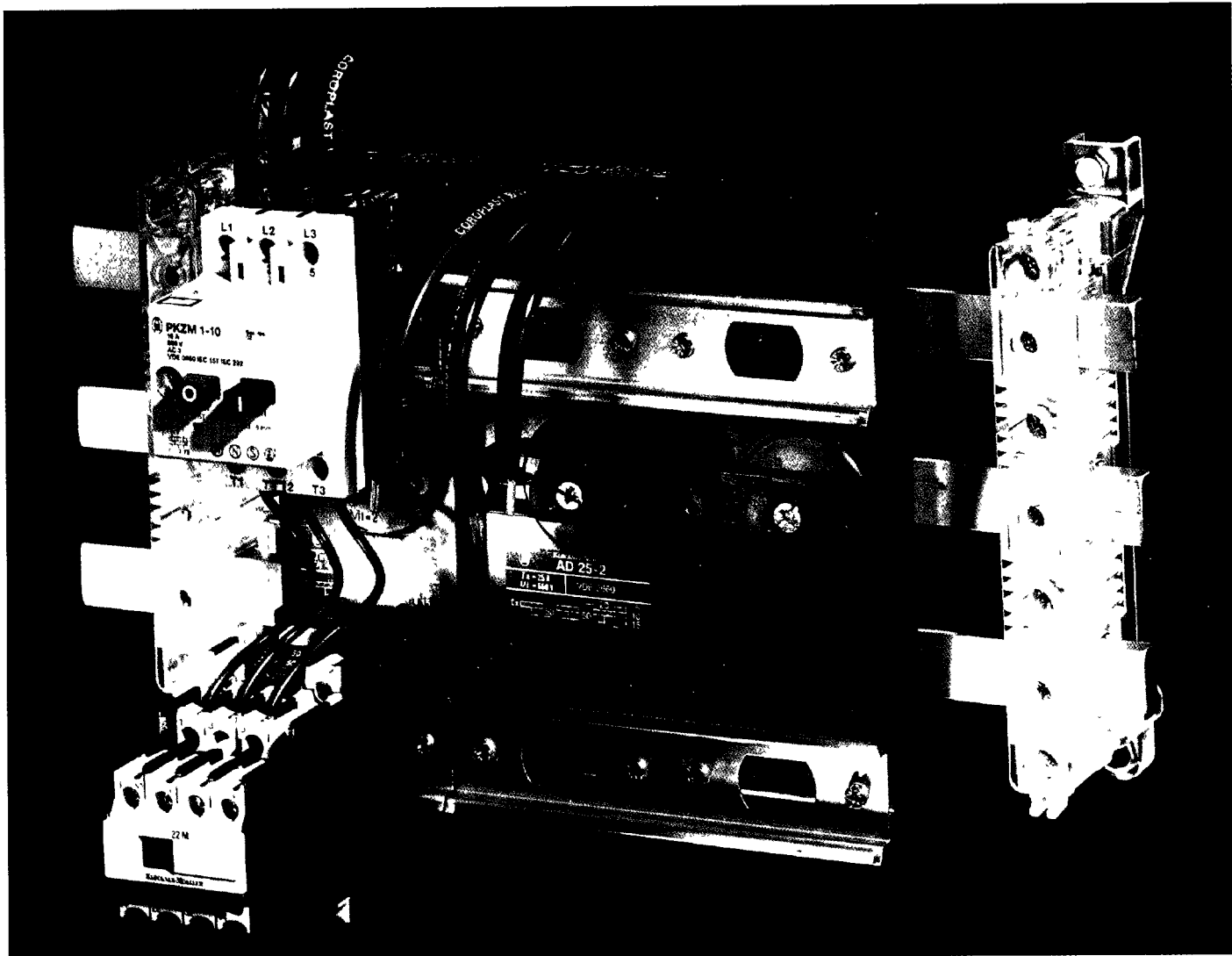

5

5

AD 25-1 (2) Busbar adapter

This adapter makes it possible for the PKZM 1 and the motor starter combination to be snap-fitted directly onto busbars with a cross-section of $20 \times 5 \text{ mm}^2$ (10, 15) at intervals of 50 mm.

● N(V)Hi auxiliary contacts can also be fitted.

With a Complete Range of Accessories



1

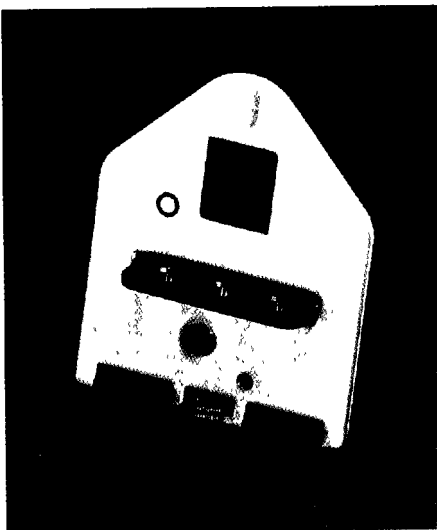

2

Emergency-stop mushroom button

With interlock and locking facility/IP 55 (used in conjunction with surface-mounting or flush-mounting versions)

Padlocking feature

(Used in conjunction with version "i", "e", "z"). Permits use as maintenance switch

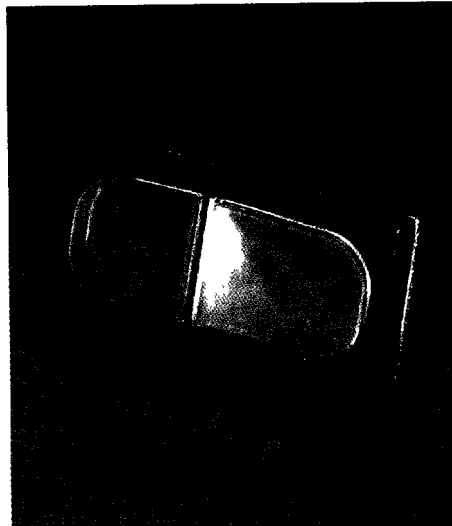

3



4

Push-button diaphragm

(Used in conjunction with version "i", "e", "z") IP 55 degree of protection, for reliable operation in severe environmental conditions

4

Indicator lights

(Used in conjunction with version "i", "e") for additional indication of operational state

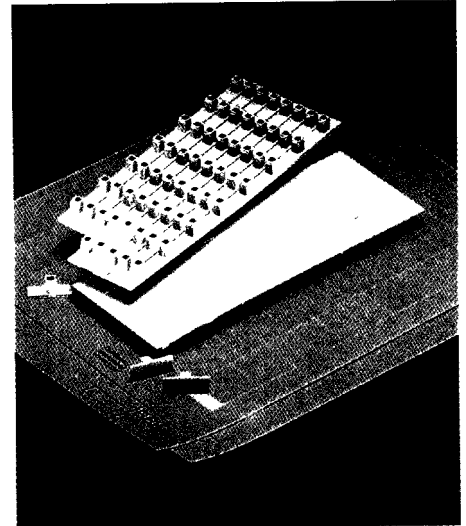

5

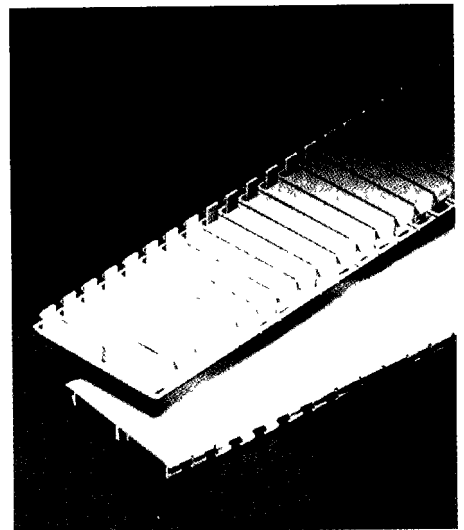

6

Component labelling system

For quick and easy identification

6

Blanking plates

Practical aids for the user

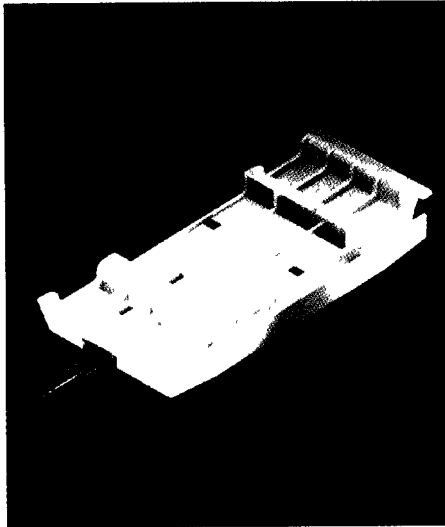

7

Adapter plate

For combining contactor and manual motor starter. Snap-on fit on top-hat rail to EN 50 022-35, or latch directly onto busbar using a busbar adapter

8/9

7

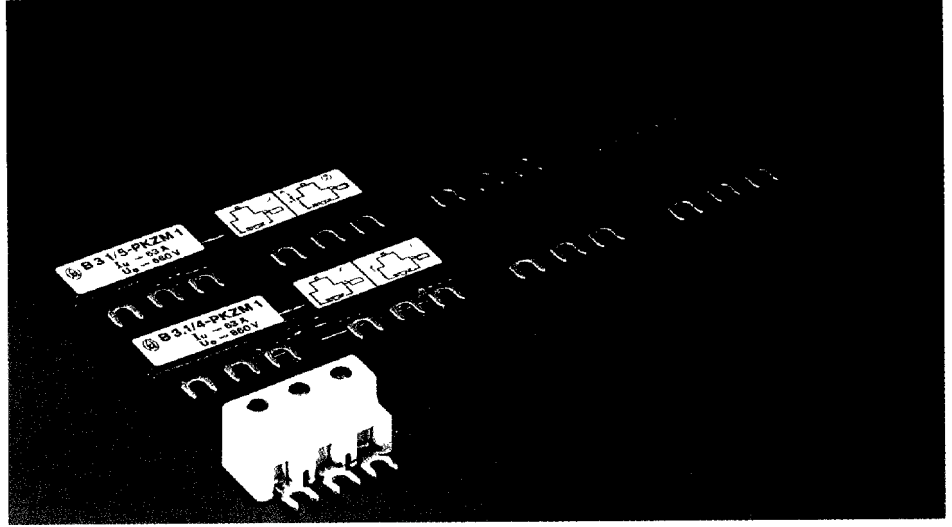

10

Three-phase commoning link

210 mm length for four PKZM 1 or 275 mm length for five PKZM 1; for speedy and economical connection of several PKZM 1 manual motor starters with space-saving 25 mm² extension terminal

10

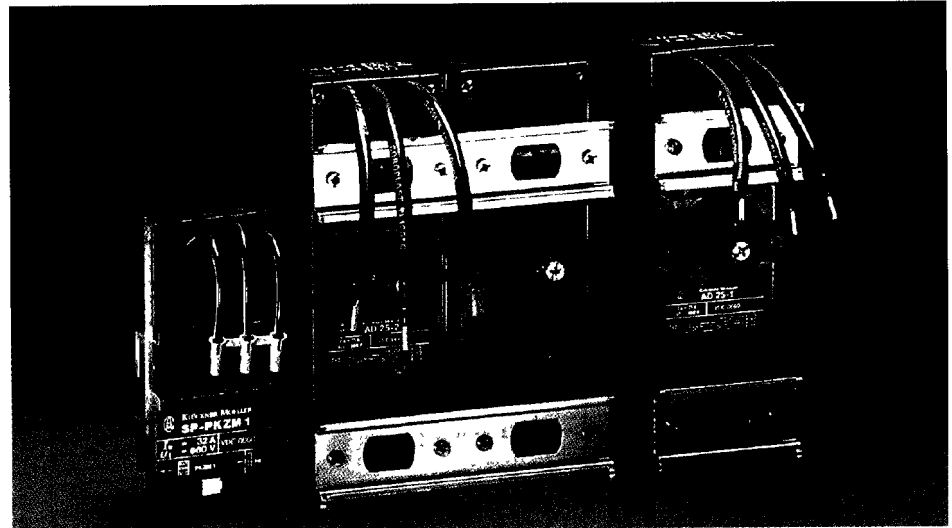

11

Fifth conductor

Simple fitting (in conjunction with version "i", "e"), does not impair performance with fitted auxiliary contacts

8

Fast-on connector for blade terminals

Permits the use of standardized, prefabricated cables

9

Busbar adapters

For fitting on busbars in distribution boards and control panels

11

Technical Data

PKZM 1 manual motor starter

General	<ul style="list-style-type: none"> Specifications 	IEC, BS, UL, CSA, VDE, SEV, UTE, ÖVE, AEI, NBN, DEMKO, NEMKO, SEMKO, Finland
Main contacts	<ul style="list-style-type: none"> Rated insulation voltage U_i Insulation group C/VDE 0110 Uninterrupted current I_u = rated operational current I_o Frequency Contact lifespan to AC-3 at max. rated operational current I_o Current heat losses (3 contacts, uninterrupted current I_u) 	660 V Setting of overload releases in A 40–60 Hz 0.1 × 10 ⁶ operations 6 W
Releases	<ul style="list-style-type: none"> Adjustable overload releases Short-circuit releases Undervoltage releases (pick-up 80% U_n, drop-out 70 . 35% U_n) Shunt releases (pick-up 70% U_n) Temperature compensation Single-phasing sensitivity Protection for EExe motors 	Total range 0 1-25 A ~ 12 × I_o 3/2 (100% DF) VA/W 3/2 (100% DF) VA/W –5 to +40°C min./max. to IEC 292-1 To IEC 292-1 PTB certification

I_o = rated operational current
= upper value of overload release setting range

CL-PKZM 1 current limiter with SEV approval ③

<ul style="list-style-type: none"> Rated breaking capacity of the combined unit P-1 Uninterrupted current I_u Max let-through current Max. time of current flow t 	See table below 32 A 6 kA 3.5 ms
---	---

Allocation of current limiter to manual motor starter

Manual motor starter Setting range	$U_o \rightarrow$ I_{cn}	$I_{cn \text{ eff}}$ with CL current limiter	
		220/240 V kA	380 V kA
A	Type		
0.1- 0.16	PKZM 1- 0.16	No protective device required	
4.0- 6.0	PKZM 1- 6	Inherently short-circuit-proof ranges	
6.0-10.0	PKZM 1-10		50
10.0-16.0	PKZM 1-16	100	50
16.0-20.0	PKZM 1-20	100	50
20.0-25.0	PKZM 1-25	100	11

