

**SCHOTTKY RECTIFIER**

**1.1 Amp**

**Major Ratings and Characteristics**

Characteristics	11DQ..	Units
$I_{F(AV)}$ Rectangular waveform	1.1	A
$V_{RRM}$	90/100	V
$I_{FSM}$ @ $t_p = 5 \mu s$ sine	90	A
$V_F$ @ 1 Apk, $T_J = 25^\circ C$	0.85	V
$T_J$ range	-40 to 125	$^\circ C$

**Description/Features**

The 11DQ.. axial leaded Schottky rectifier has been optimized for very low forward voltage drop, with moderate leakage. Typical applications are in switching power supplies, converters, free-wheeling diodes, and reverse battery protection.

- Low profile, axial leaded outline
- High purity, high temperature epoxy encapsulation for enhanced mechanical strength and moisture resistance
- Very low forward voltage drop
- High frequency operation
- Guard ring for enhanced ruggedness and long term reliability

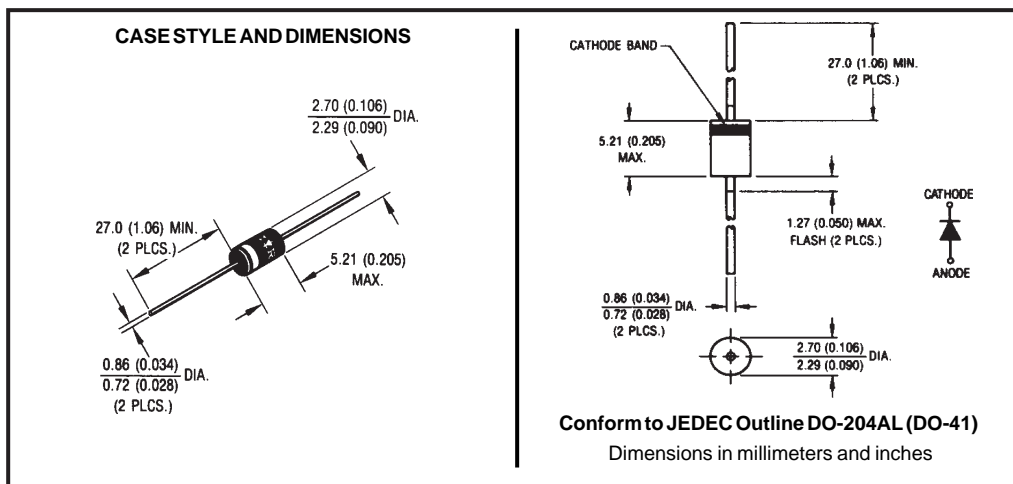

### Voltage Ratings

Part number	11DQ09	11DQ10
$V_R$ Max. DC Reverse Voltage (V)	90	100
$V_{RWM}$ Max. Working Peak Reverse Voltage (V)		

### Absolute Maximum Ratings

Parameters	11DQ..	Units	Conditions
$I_{F(AV)}$ Max. Average Forward Current * See Fig. 4	1.1	A	50% duty cycle @ $T_C=48^\circ\text{C}$ , rectangular waveform
$I_{FSM}$ Max. Peak One Cycle Non-Repetitive Surge Current * See Fig. 6	90	A	5 $\mu\text{s}$ Sine or 3 $\mu\text{s}$ Rect. pulse 10ms Sine or 6ms Rect. pulse
	15		

### Electrical Specifications

Parameters	11DQ..	Units	Conditions
$V_{FM}$ Max. Forward Voltage Drop * See Fig. 1 (1)	0.85	V	@ 1A $T_J = 25^\circ\text{C}$
	0.96	V	@ 2A
	0.68	V	@ 1A $T_J = 125^\circ\text{C}$
	0.78	V	@ 2A
$I_{RM}$ Max. Reverse Leakage Current * See Fig. 2 (1)	0.5	mA	$T_J = 25^\circ\text{C}$ $V_R = \text{rated } V_R$
	1.0	mA	$T_J = 125^\circ\text{C}$
$C_T$ Typical Junction Capacitance	35	pF	$V_R = 5V_{DC}$ , (test signal range 100Khz to 1Mhz) $25^\circ\text{C}$
$L_S$ Typical Series Inductance	8.0	nH	Measured lead to lead 5mm from package body

(1) Pulse Width < 300 $\mu\text{s}$ , Duty Cycle <2%

### Thermal-Mechanical Specifications

Parameters	11DQ..	Units	Conditions
$T_J$ Max. Junction Temperature Range	-40 to 125	$^\circ\text{C}$	
$T_{stg}$ Max. Storage Temperature Range	-40 to 125	$^\circ\text{C}$	
$R_{thJA}$ Max. Thermal Resistance Junction to Ambient	130	$^\circ\text{C}/\text{W}$	DC operation Without cooling fin
$R_{thJA}$ Typical Thermal Resistance Junction to Ambient with PC Board Mounted	81	$^\circ\text{C}/\text{W}$	PC board mounted [L=8mm (0.315 in.)] Solder land area 100mm <sup>2</sup> (0.155 in. <sup>2</sup> .)
wt Approximate Weight	0.33(0.012)	g(oz.)	
Case Style	DO-204AL(DO-41)		

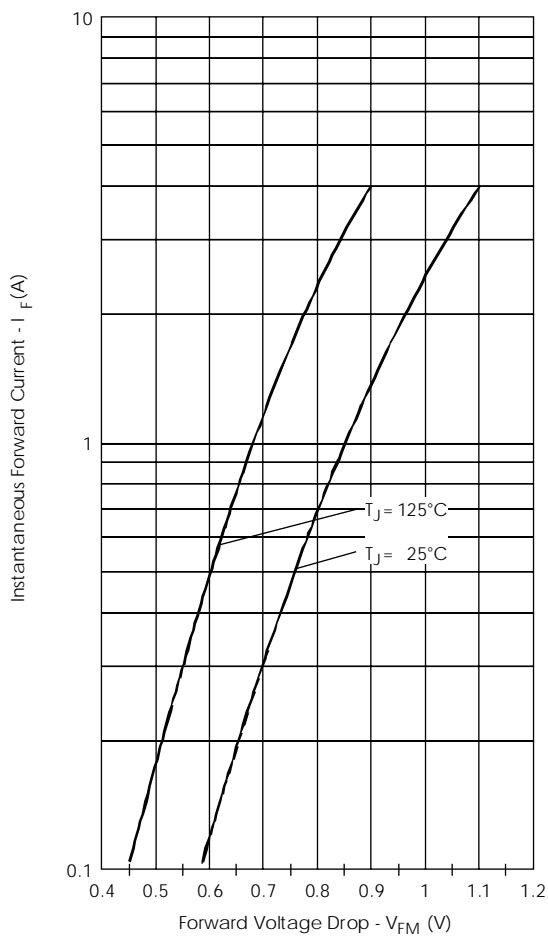

Fig. 1 - Maximum Forward Voltage Drop Characteristics

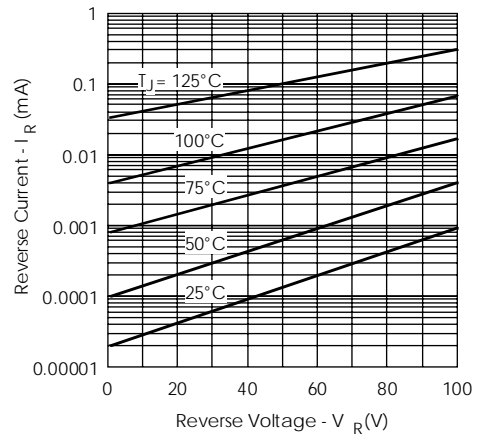

Fig. 2 - Typical Values of Reverse Current Vs. Reverse Voltage

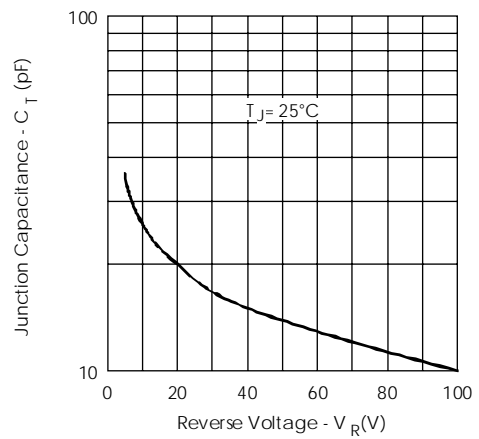

Fig. 3 - Typical Junction Capacitance Vs. Reverse Voltage

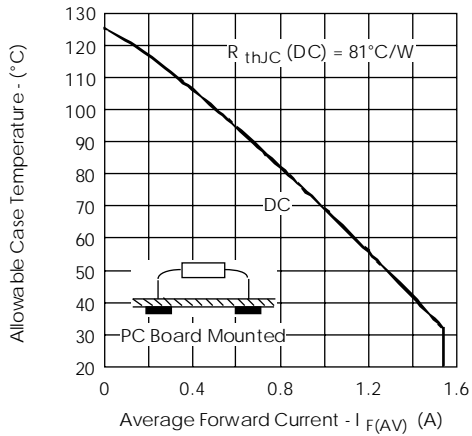

Fig. 4 - Maximum Ambient Temperature Vs. Average Forward Current, Printed Circuit Board Mounted

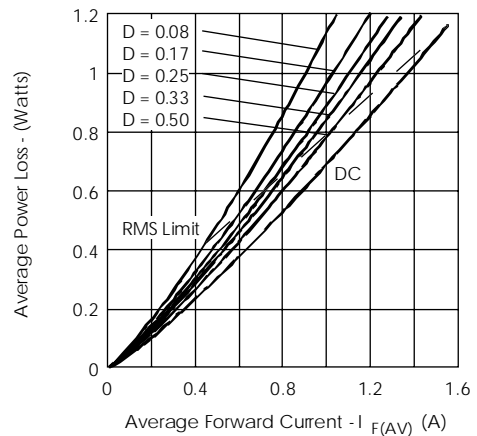

Fig. 5 - Forward Power Loss Characteristics

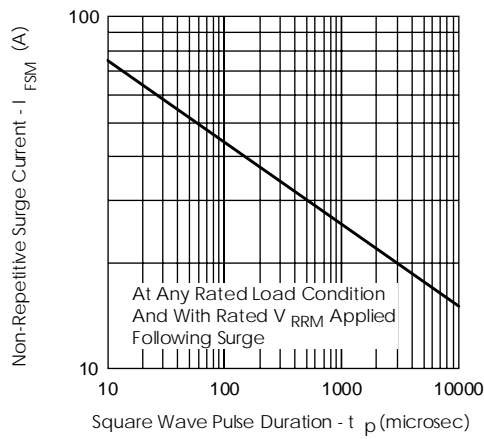

Fig. 6 - Maximum Non-Repetitive Surge Current