

MJW21195 (PNP) MJW21196 (NPN)

Silicon Power Transistors

The MJW21195 and MJW21196 utilize Perforated Emitter technology and are specifically designed for high power audio output, disk head positioners and linear applications.

Features

- Total Harmonic Distortion Characterized
- High DC Current Gain – $h_{FE} = 20 \text{ Min @ } I_C = 8 \text{ A dc}$
- Excellent Gain Linearity
- High SOA: 2.25 A, 80 V, 1 Second
- Pb-Free Packages are Available*

MAXIMUM RATINGS

Rating	Symbol	Value	Unit
Collector–Emitter Voltage	V_{CEO}	250	Vdc
Collector–Base Voltage	V_{CBO}	400	Vdc
Emitter–Base Voltage	V_{EBO}	5.0	Vdc
Collector–Emitter Voltage – 1.5 V	V_{CEX}	400	Vdc
Collector Current – Continuous – Peak (Note 1)	I_C	16 30	A dc
Base Current – Continuous	I_B	5.0	A dc
Total Power Dissipation @ $T_C = 25^\circ\text{C}$ Derate Above 25°C	P_D	200 1.43	W W/ $^\circ\text{C}$
Operating and Storage Junction Temperature Range	T_J, T_{stg}	–65 to +150	$^\circ\text{C}$

THERMAL CHARACTERISTICS

Characteristic	Symbol	Max	Unit
Thermal Resistance, Junction–to–Case	$R_{\theta JC}$	0.7	$^\circ\text{C/W}$
Thermal Resistance, Junction–to–Ambient	$R_{\theta JA}$	40	$^\circ\text{C/W}$

Stresses exceeding Maximum Ratings may damage the device. Maximum Ratings are stress ratings only. Functional operation above the Recommended Operating Conditions is not implied. Extended exposure to stresses above the Recommended Operating Conditions may affect device reliability.

1. Pulse Test: Pulse Width = 5 μs , Duty Cycle $\leq 10\%$.



ON Semiconductor®

<http://onsemi.com>

**16 AMPERES
COMPLEMENTARY
SILICON POWER TRANSISTORS
250 VOLTS, 200 WATTS**

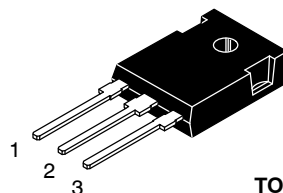

**TO–247
CASE 340L**

MARKING DIAGRAM

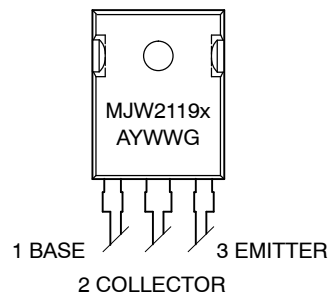

x = 5 or 6
A = Assembly Location
Y = Year
WW = Work Week
G = Pb-Free Package

ORDERING INFORMATION

Device	Package	Shipping
MJW21195	TO–247	30 Units/Rail
MJW21195G	TO–247 (Pb–Free)	30 Units/Rail
MJW21196	TO–247	30 Units/Rail
MJW21196G	TO–247 (Pb–Free)	30 Units/Rail

*For additional information on our Pb-Free strategy and soldering details, please download the ON Semiconductor Soldering and Mounting Techniques Reference Manual, SOLDERRM/D.

MJW21195 (PNP) MJW21196 (NPN)

ELECTRICAL CHARACTERISTICS (T_C = 25°C unless otherwise noted)

Characteristic	Symbol	Min	Typical	Max	Unit	
OFF CHARACTERISTICS						
Collector-Emitter Sustaining Voltage (I _C = 100 mAdc, I _B = 0)	V _{CEO(sus)}	250	–	–	Vdc	
Collector Cutoff Current (V _{CE} = 200 Vdc, I _B = 0)	I _{CEO}	–	–	100	μAdc	
Emitter Cutoff Current (V _{CE} = 5 Vdc, I _C = 0)	I _{EBO}	–	–	50	μAdc	
Collector Cutoff Current (V _{CE} = 250 Vdc, V _{BE(off)} = 1.5 Vdc)	I _{CEX}	–	–	50	μAdc	
SECOND BREAKDOWN						
Second Breakdown Collector Current with Base Forward Biased (V _{CE} = 50 Vdc, t = 1 s (non-repetitive)) (V _{CE} = 80 Vdc, t = 1 s (non-repetitive))	I _{S/b}	4.0 2.25	– –	– –	Adc	
ON CHARACTERISTICS						
DC Current Gain (I _C = 8 Adc, V _{CE} = 5 Vdc) (I _C = 16 Adc, I _B = 5 Adc)	h _{FE}	20 8	– –	80 –		
Base-Emitter On Voltage (I _C = 8 Adc, V _{CE} = 5 Vdc)	V _{BE(on)}	–	–	2.0	Vdc	
Collector-Emitter Saturation Voltage (I _C = 8 Adc, I _B = 0.8 Adc) (I _C = 16 Adc, I _B = 3.2 Adc)	V _{CE(sat)}	– –	– –	1.0 3	Vdc	
DYNAMIC CHARACTERISTICS						
Total Harmonic Distortion at the Output V _{RMS} = 28.3 V, f = 1 kHz, P _{LOAD} = 100 W _{RMS} (Matched pair h _{FE} = 50 @ 5 A/5 V)	h _{FE} unmatched h _{FE} matched	T _{HD}	– –	0.8 0.08	– –	%
Current Gain Bandwidth Product (I _C = 1 Adc, V _{CE} = 10 Vdc, f _{test} = 1 MHz)	f _T	4	–	–	MHz	
Output Capacitance (V _{CB} = 10 Vdc, I _E = 0, f _{test} = 1 MHz)	C _{ob}	–	–	500	pF	

MJW21195 (PNP) MJW21196 (NPN)

TYPICAL CHARACTERISTICS

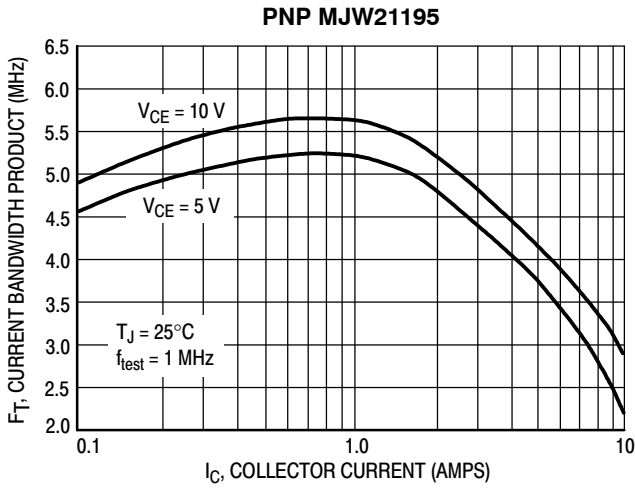

Figure 1. Typical Current Gain Bandwidth Product

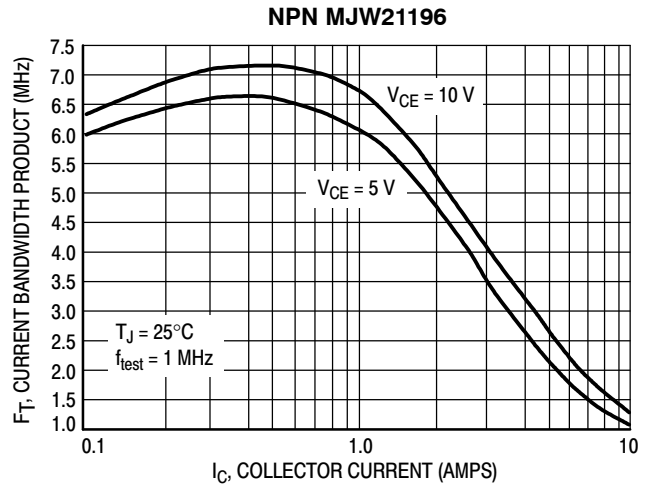

Figure 2. Typical Current Gain Bandwidth Product

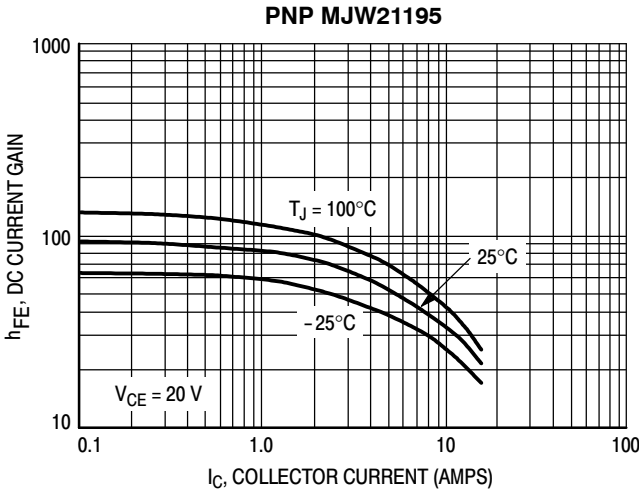

Figure 3. DC Current Gain, $V_{CE} = 20\text{ V}$

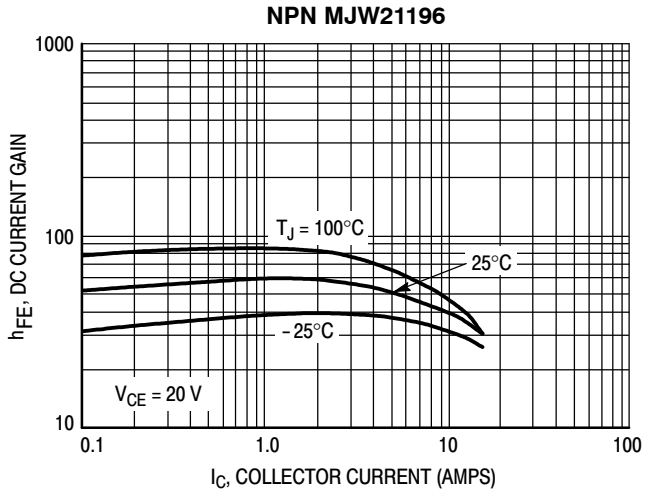

Figure 4. DC Current Gain, $V_{CE} = 20\text{ V}$

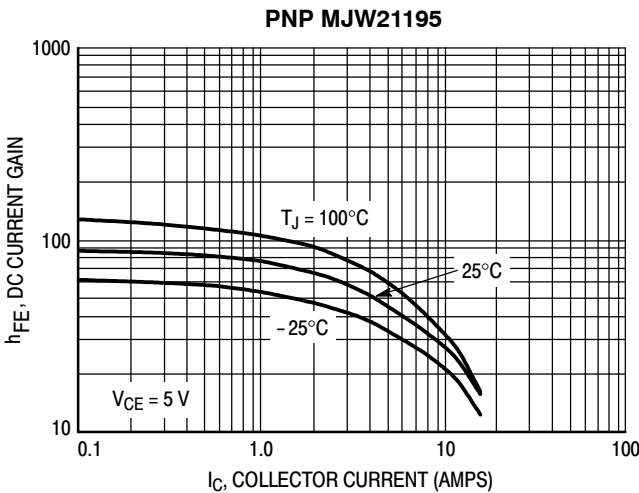

Figure 5. DC Current Gain, $V_{CE} = 5\text{ V}$

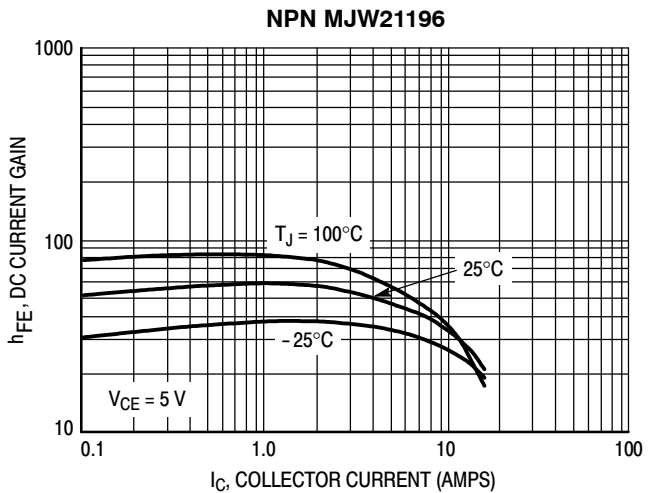

Figure 6. DC Current Gain, $V_{CE} = 5\text{ V}$

MJW21195 (PNP) MJW21196 (NPN)

TYPICAL CHARACTERISTICS

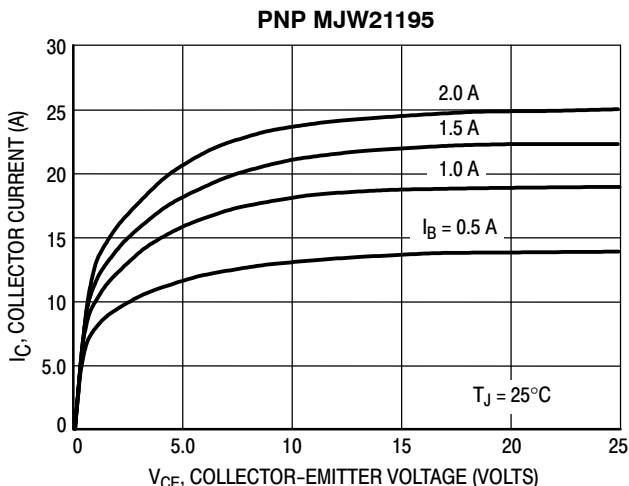

Figure 7. Typical Output Characteristics

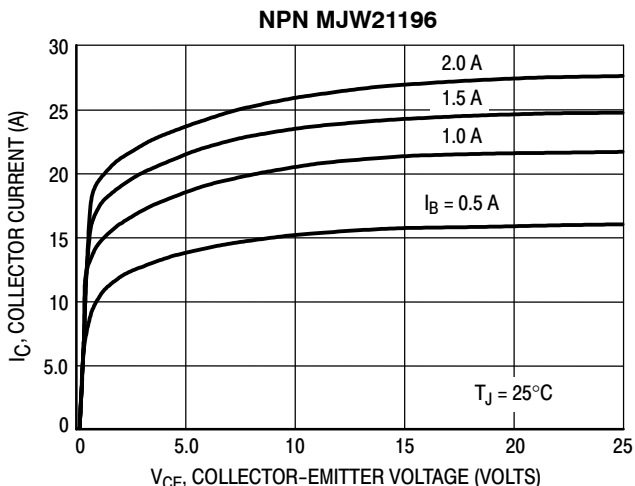

Figure 8. Typical Output Characteristics

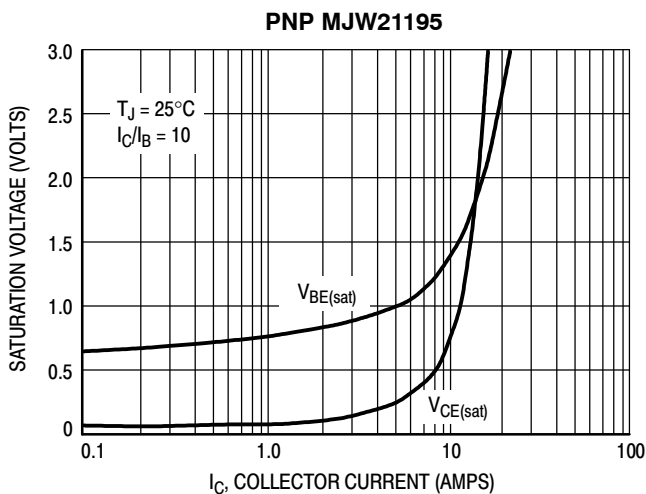

Figure 9. Typical Saturation Voltages

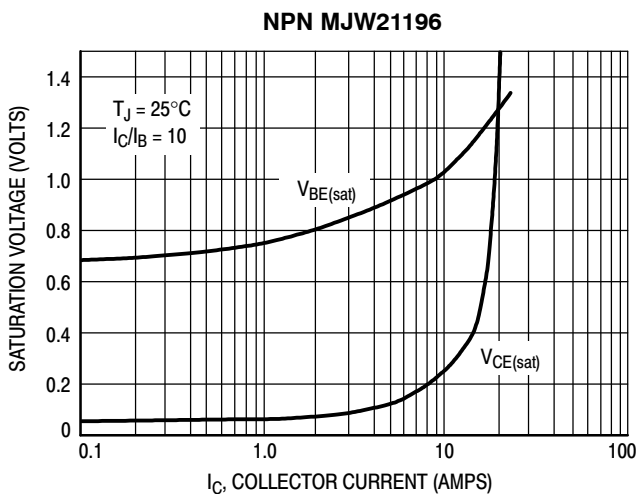

Figure 10. Typical Saturation Voltages

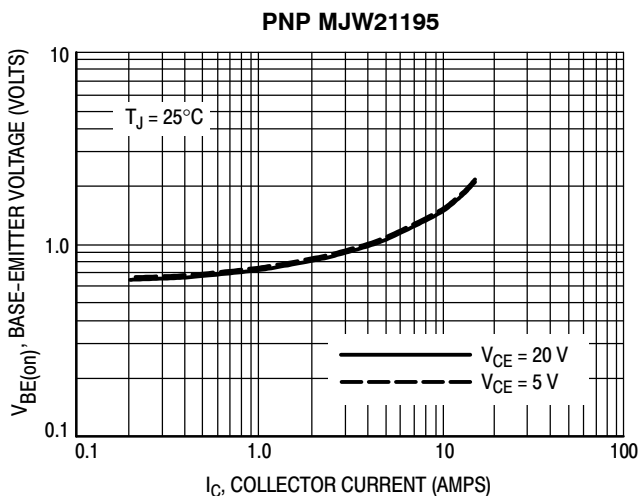

Figure 11. Typical Base-Emitter Voltage

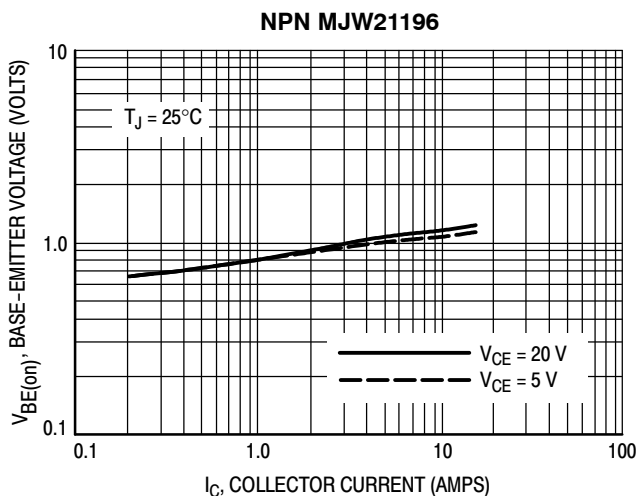

Figure 12. Typical Base-Emitter Voltage

MJW21195 (PNP) MJW21196 (NPN)

There are two limitations on the power handling ability of a transistor; average junction temperature and secondary breakdown. Safe operating area curves indicate $I_C - V_{CE}$ limits of the transistor that must be observed for reliable operation; i.e., the transistor must not be subjected to greater dissipation than the curves indicate.

The data of Figure 13 is based on $T_{J(pk)} = 150^\circ\text{C}$; T_C is variable depending on conditions. At high case temperatures, thermal limitations will reduce the power than can be handled to values less than the limitations imposed by second breakdown.

TYPICAL CHARACTERISTICS

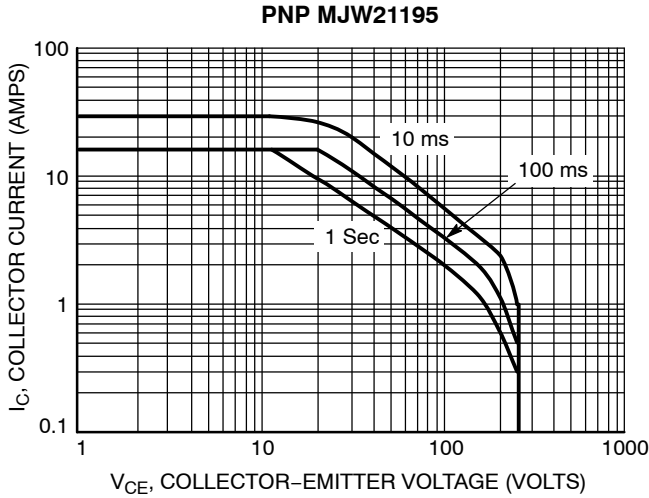

Figure 13. Active Region Safe Operating Area

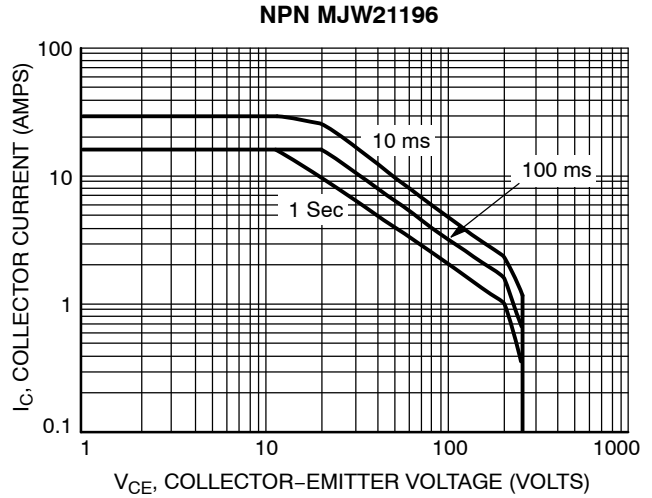

Figure 14. Active Region Safe Operating Area

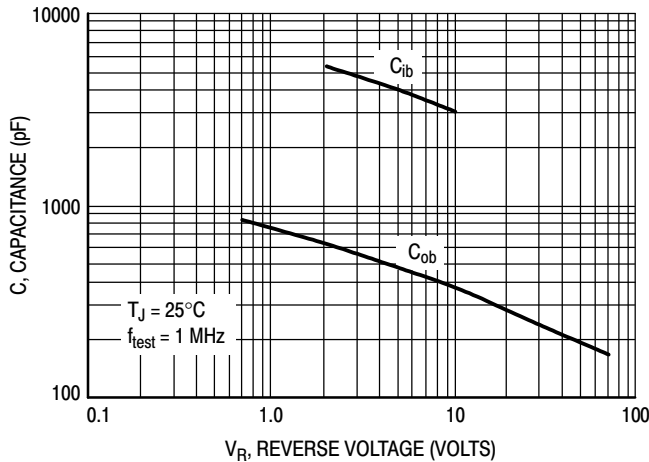

Figure 15. MJW21195 Typical Capacitance

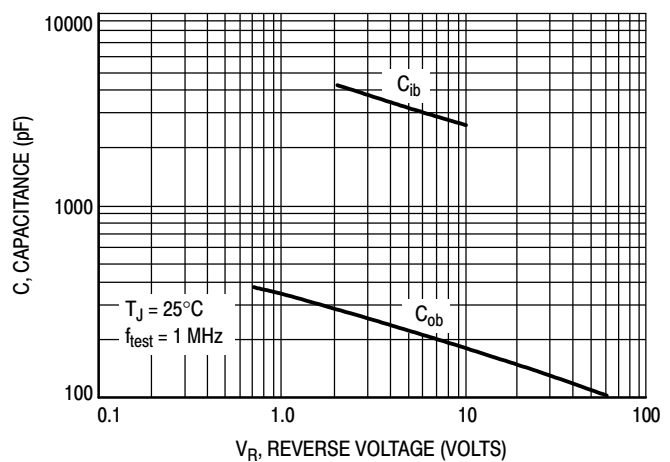

Figure 16. MJW21196 Typical Capacitance

MJW21195 (PNP) MJW21196 (NPN)

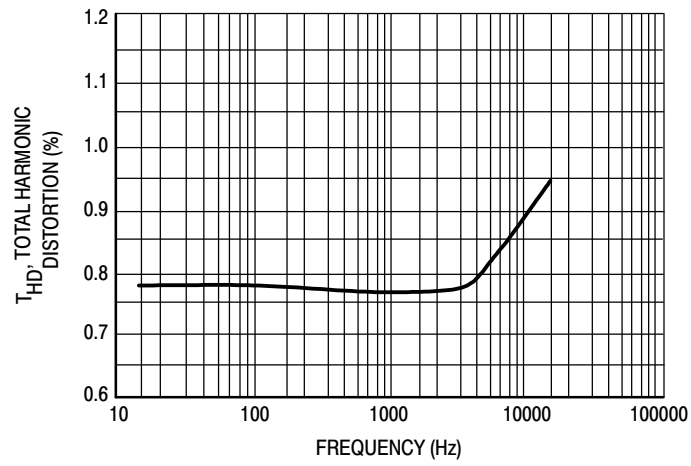

Figure 17. Typical Total Harmonic Distortion

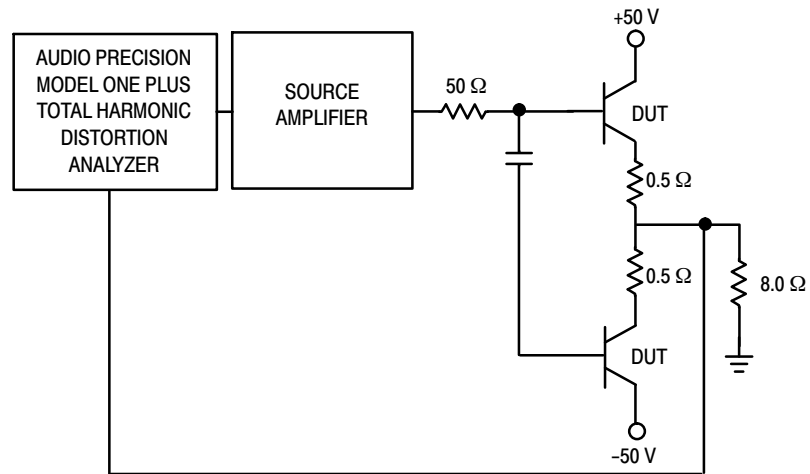
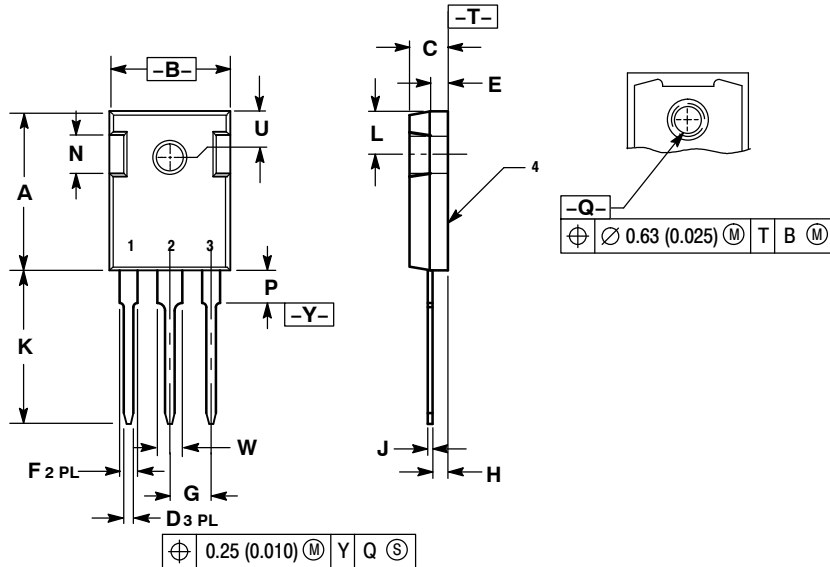

Figure 18. Total Harmonic Distortion Test Circuit

MJW21195 (PNP) MJW21196 (NPN)

PACKAGE DIMENSIONS

TO-247
CASE 340L-02
ISSUE E



NOTES:

1. DIMENSIONING AND TOLERANCING PER ANSI Y14.5M, 1982.
2. CONTROLLING DIMENSION: MILLIMETER.

DIM	MILLIMETERS		INCHES	
	MIN	MAX	MIN	MAX
A	20.32	21.08	0.800	0.830
B	15.75	16.26	0.620	0.640
C	4.70	5.30	0.185	0.209
D	1.00	1.40	0.040	0.055
E	1.90	2.60	0.075	0.102
F	1.65	2.13	0.065	0.084
G	5.45 BSC		0.215 BSC	
H	1.50	2.49	0.059	0.098
J	0.40	0.80	0.016	0.031
K	19.81	20.83	0.780	0.820
L	5.40	6.20	0.212	0.244
N	4.32	5.49	0.170	0.216
P	---	4.50	---	0.177
Q	3.55	3.65	0.140	0.144
U	6.15 BSC		0.242 BSC	
W	2.87	3.12	0.113	0.123

ON Semiconductor and are registered trademarks of Semiconductor Components Industries, LLC (SCILLC). SCILLC reserves the right to make changes without further notice to any products herein. SCILLC makes no warranty, representation or guarantee regarding the suitability of its products for any particular purpose, nor does SCILLC assume any liability arising out of the application or use of any product or circuit, and specifically disclaims any and all liability, including without limitation special, consequential or incidental damages. "Typical" parameters which may be provided in SCILLC data sheets and/or specifications can and do vary in different applications and actual performance may vary over time. All operating parameters, including "Typicals" must be validated for each customer application by customer's technical experts. SCILLC does not convey any license under its patent rights nor the rights of others. SCILLC products are not designed, intended, or authorized for use as components in systems intended for surgical implant into the body, or other applications intended to support or sustain life, or for any other application in which the failure of the SCILLC product could create a situation where personal injury or death may occur. Should Buyer purchase or use SCILLC products for any such unintended or unauthorized application, Buyer shall indemnify and hold SCILLC and its officers, employees, subsidiaries, affiliates, and distributors harmless against all claims, costs, damages, and expenses, and reasonable attorney fees arising out of, directly or indirectly, any claim of personal injury or death associated with such unintended or unauthorized use, even if such claim alleges that SCILLC was negligent regarding the design or manufacture of the part. SCILLC is an Equal Opportunity/Affirmative Action Employer. This literature is subject to all applicable copyright laws and is not for resale in any manner.

PUBLICATION ORDERING INFORMATION

LITERATURE FULFILLMENT:

Literature Distribution Center for ON Semiconductor
P.O. Box 5163, Denver, Colorado 80217 USA
Phone: 303-675-2175 or 800-344-3860 Toll Free USA/Canada
Fax: 303-675-2176 or 800-344-3867 Toll Free USA/Canada
Email: orderlit@onsemi.com

N. American Technical Support: 800-282-9855 Toll Free
USA/Canada
Europe, Middle East and Africa Technical Support:
Phone: 421 33 790 2910
Japan Customer Focus Center
Phone: 81-3-5773-3850

ON Semiconductor Website: www.onsemi.com

Order Literature: <http://www.onsemi.com/orderlit>

For additional information, please contact your local Sales Representative