

International
IOR Rectifier

30BQ040PbF

SCHOTTKY RECTIFIER

3 Amp

$$I_{F(AV)} = 3.0\text{Amp}$$

$$V_R = 40\text{V}$$

Major Ratings and Characteristics

Characteristics	Value	Units
$I_{F(AV)}$ Rectangular waveform	3.0	A
V_{RRM}	40	V
I_{FSM} @ $t_p=5\mu\text{s}$ sine	2000	A
V_F @ 3.0 Apk, $T_J=125^\circ\text{C}$	0.43	V
T_J range	- 55 to 150	$^\circ\text{C}$

Description/ Features

The 30BQ040PbF surface-mount Schottky rectifier has been designed for applications requiring low forward drop and small foot prints on PC boards. Typical applications are in disk drives, switching power supplies, converters, free-wheeling diodes, battery charging, and reverse battery protection.

- Small foot print, surface mountable
- Very low forward voltage drop
- High frequency operation
- Guard ring for enhanced ruggedness and long term reliability
- Lead-Free ("PbF" suffix)

Case Styles

30BQ040PbF



SMC



Voltage Ratings

Part number	30BQ040PbF
V_R Max. DC Reverse Voltage (V)	40
V_{RRM} Max. Working Peak Reverse Voltage (V)	

Absolute Maximum Ratings

Parameters	30BQ	Units	Conditions
$I_{F(AV)}$ Max. Average Forward Current	3.0	A	50% duty cycle @ $T_L = 118^\circ\text{C}$, rectangular wave form
	4.0		50% duty cycle @ $T_L = 110^\circ\text{C}$, rectangular wave form
I_{FSM} Max. Peak One Cycle Non-Repetitive Surge Current	2000	A	5 μs Sine or 3 μs Rect. pulse
	110		10ms Sine or 6ms Rect. pulse
E_{AS} Non Repetitive Avalanche Energy	6.0	mJ	$T_J = 25^\circ\text{C}$, $I_{AS} = 1.0\text{A}$, $L = 12\text{mH}$
I_{AR} Repetitive Avalanche Current	1.0	A	Current decaying linearly to zero in 1 μsec Frequency limited by T_J max. $V_a = 1.5 \times V_r$ typical

Electrical Specifications

Parameters	30BQ	Units	Conditions
V_{FM} Max. Forward Voltage Drop (1)	0.53	V	@ 3A $T_J = 25^\circ\text{C}$
	0.68	V	@ 6A $T_J = 25^\circ\text{C}$
	0.43	V	@ 3A $T_J = 125^\circ\text{C}$
	0.57	V	@ 6A $T_J = 125^\circ\text{C}$
I_{RM} Max. Reverse Leakage Current (1)	0.5	mA	$T_J = 25^\circ\text{C}$ $V_R = \text{rated } V_R$
	30	mA	$T_J = 125^\circ\text{C}$
C_T Max. Junction Capacitance	230	pF	$V_R = 5V_{DC}$ (test signal range 100KHz to 1Mhz) 25°C
L_S Typical Series Inductance	3.0	nH	Measured lead to lead 5mm from package body
dv/dt Max. Voltage Rate of Change	10000	V/ μs	(Rated V_R)

(1) Pulse Width < 300 μs , Duty Cycle < 2%

Thermal-Mechanical Specifications

Parameters	30BQ	Units	Conditions
T_J Max. Junction Temperature Range (*)	-55 to 150	$^\circ\text{C}$	
T_{stg} Max. Storage Temperature Range	-55 to 150	$^\circ\text{C}$	
R_{thJL} Max. Thermal Resistance Junction to Lead (**)	12	$^\circ\text{C}/\text{W}$	DC operation
R_{thJA} Max. Thermal Resistance Junction to Ambient	46	$^\circ\text{C}/\text{W}$	DC operation
wt Approximate Weight	0.24 (0.008)	g (oz.)	
Case Style	SMC		Similar to DO-214AB
Device Marking	IR3F		

(*) $\frac{dP_{tot}}{dT_J} < \frac{1}{R_{th(j-a)}}$ thermal runaway condition for a diode on its own heatsink

(**) Mounted 1 inch square PCB

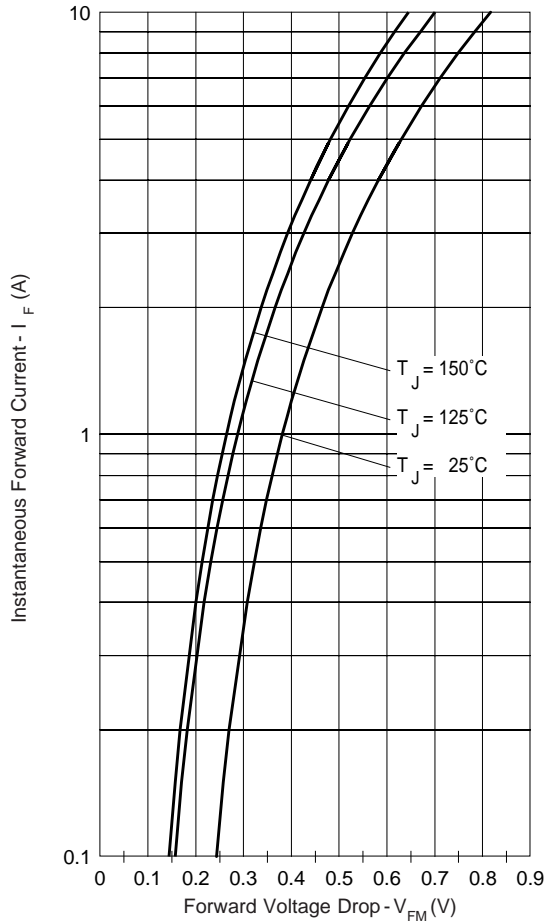

Fig. 1 - Max. Forward Voltage Drop Characteristics (Per Leg)

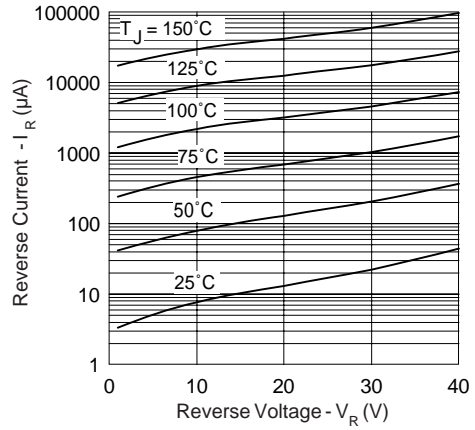

Fig. 2 - Typical Values Of Reverse Current Vs. Reverse Voltage (Per Leg)

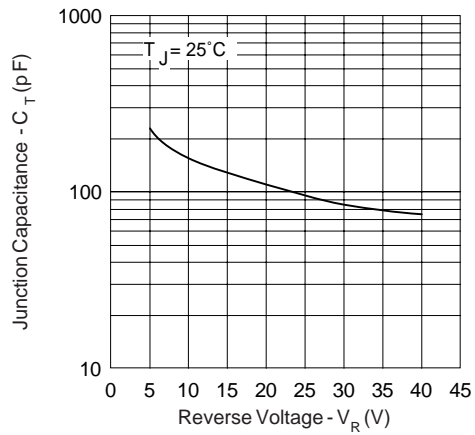

Fig. 3 - Typical Junction Capacitance Vs. Reverse Voltage (Per Leg)

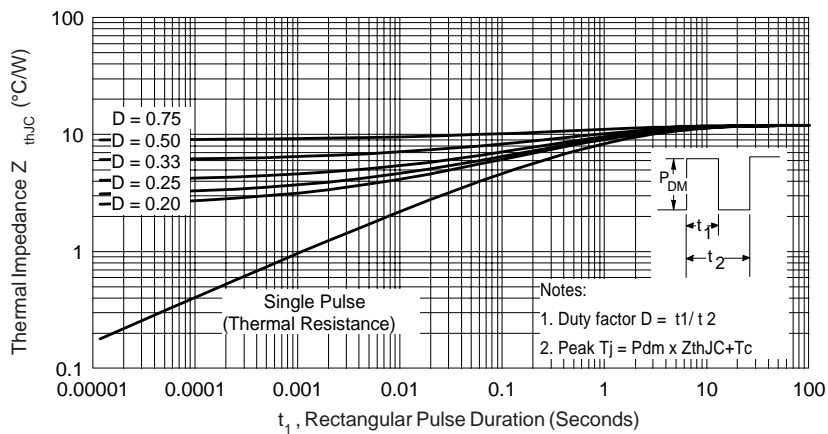

Fig. 4 - Max. Thermal Impedance Z_{thJC} Characteristics (Per Leg)

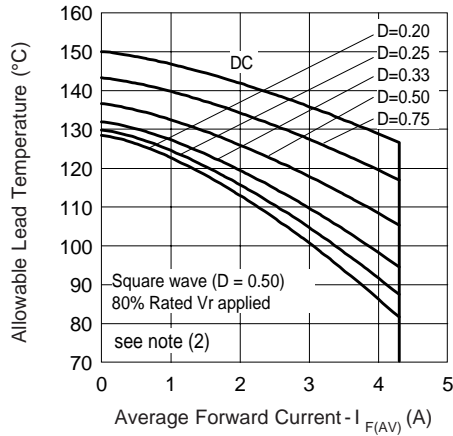

Fig. 4 - Maximum Average Forward Current Vs. Allowable Lead Temperature

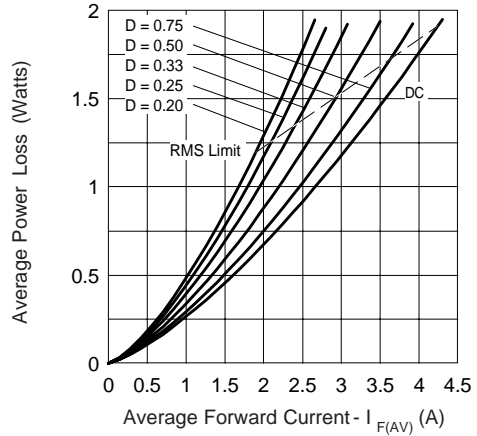

Fig. 5 - Maximum Average Forward Dissipation Vs. Average Forward Current

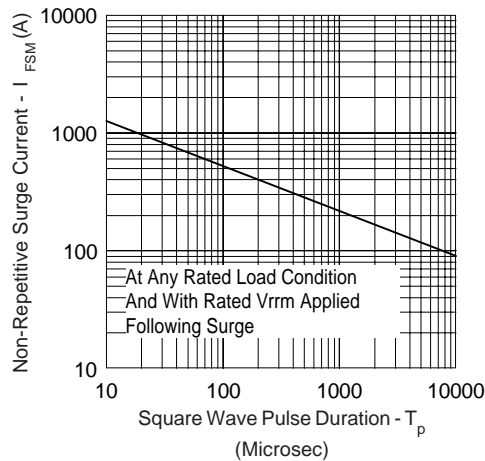

Fig. 6 - Maximum Peak Surge Forward Current Vs. Pulse Duration

(2) Formula used: $T_c = T_j - (Pd + Pd_{REV}) \times R_{thJC}$;

Pd = Forward Power Loss = $I_{F(AV)} \times V_{FM}$ @ $(I_{F(AV)}/D)$ (see Fig. 6);

Pd_{REV} = Inverse Power Loss = $V_{R1} \times I_R (1 - D)$; I_R @ $V_{R1} = 80\%$ rated V_R

Outline Table

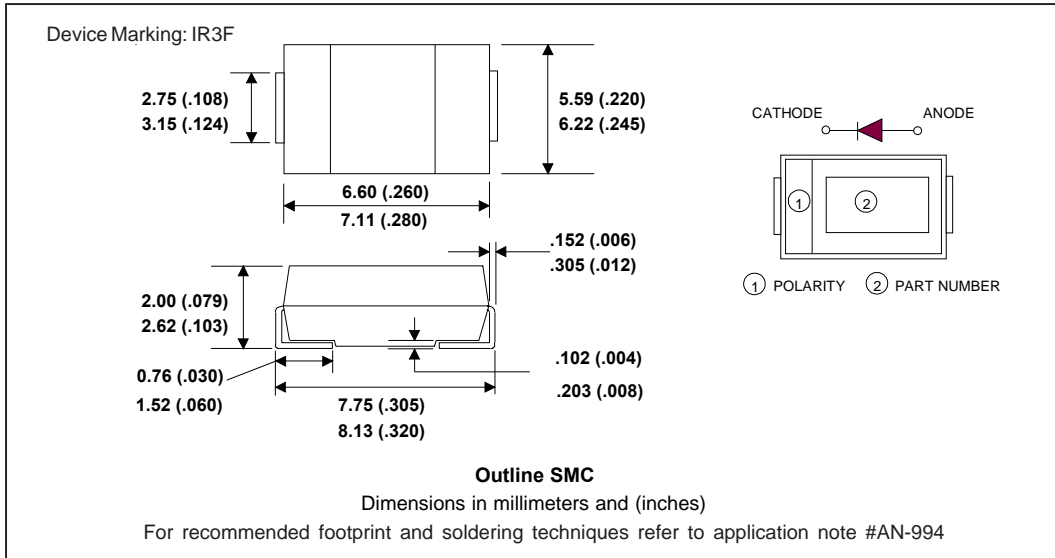

Marking & Identification

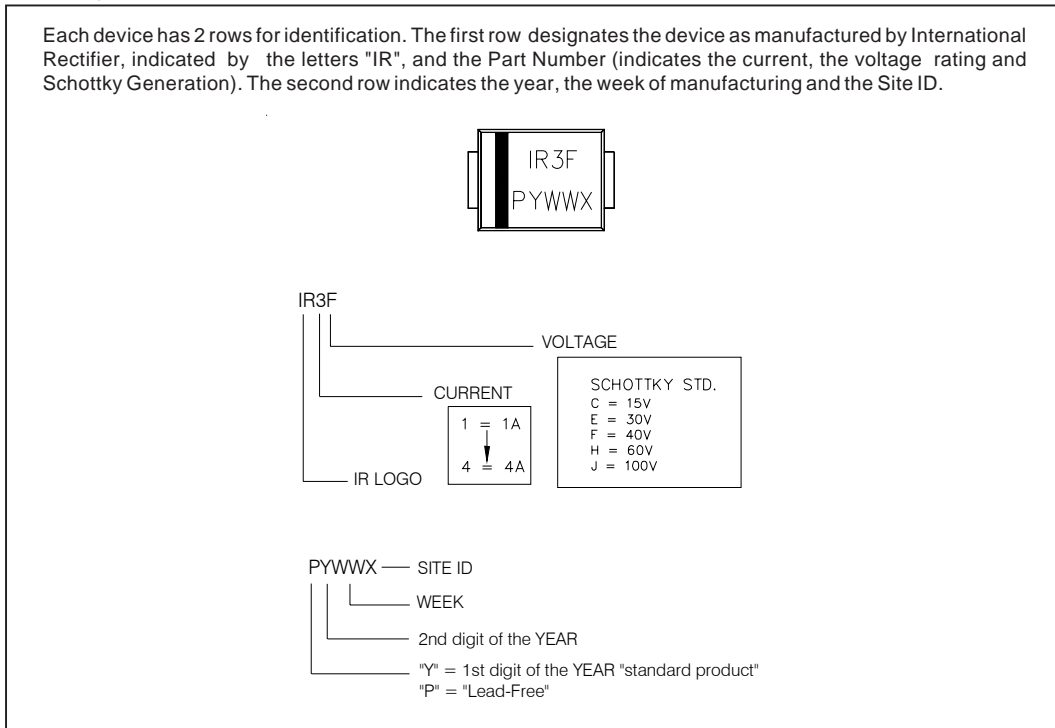

Tape & Reel Information

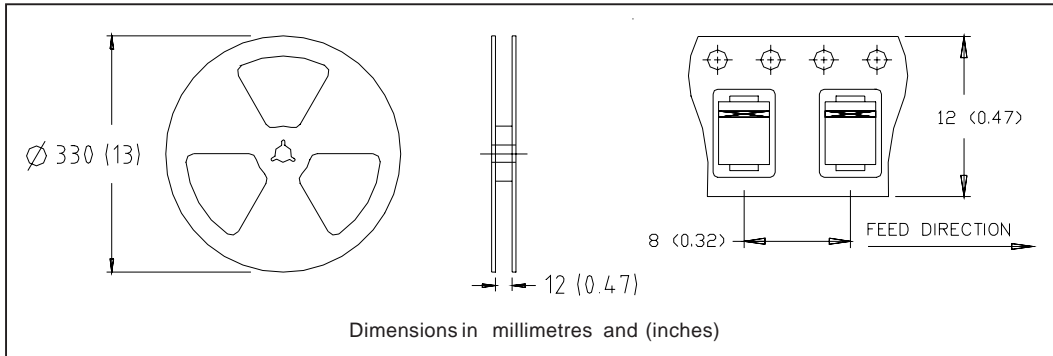

Ordering Information Table

Device Code	30	B	Q	040	TR	PbF
	1	2	3	4	5	6
1	-	Current Rating				
2	-	B = Single Lead Diode				
3	-	Q = Schottky Q Series				
4	-	Voltage Rating (040 = 40V)				
5	-	<ul style="list-style-type: none"> • none = Box (1000 pieces) • TR = Tape & Reel (3000 pieces) 				
6	-	<ul style="list-style-type: none"> • none = Standard Production • PbF = Lead-Free 				

Data and specifications subject to change without notice.
This product has been designed and qualified for Industrial Level and Lead-Free.
Qualification Standards can be found on IR's Web site.



Notice

The products described herein were acquired by Vishay Intertechnology, Inc., as part of its acquisition of International Rectifier's Power Control Systems (PCS) business, which closed in April 2007. Specifications of the products displayed herein are pending review by Vishay and are subject to the terms and conditions shown below.

Specifications of the products displayed herein are subject to change without notice. Vishay Intertechnology, Inc., or anyone on its behalf, assumes no responsibility or liability for any errors or inaccuracies.

Information contained herein is intended to provide a product description only. No license, express or implied, by estoppel or otherwise, to any intellectual property rights is granted by this document. Except as provided in Vishay's terms and conditions of sale for such products, Vishay assumes no liability whatsoever, and disclaims any express or implied warranty, relating to sale and/or use of Vishay products including liability or warranties relating to fitness for a particular purpose, merchantability, or infringement of any patent, copyright, or other intellectual property right.

The products shown herein are not designed for use in medical, life-saving, or life-sustaining applications. Customers using or selling these products for use in such applications do so at their own risk and agree to fully indemnify Vishay for any damages resulting from such improper use or sale.

International Rectifier®, IR®, the IR logo, HEXFET®, HEXSense®, HEXDIP®, DOL®, INTERO®, and POWIRTRAIN® are registered trademarks of International Rectifier Corporation in the U.S. and other countries. All other product names noted herein may be trademarks of their respective owners.