



RXM, p. 23-6



RSL, p. 23-45



SSR, p. 23-43

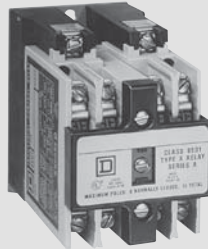

8501X, p. 23-21



CAD32, p. 23-15



9050JCK, p. 23-29



RE7, p. 23-26



ABL8, p. 23-37



REG24, REG48, REG96
p. 23-44



CA2SKE, p. 23-20



SR2, SR3, p. 23-39



RM17, RM35 p. 23-30

General Purpose Relays

<i>New!</i> Zelio® Plug-in Relays	RXM, RPM, RUM, RPF, RSB, RSL	23-2
Square D® Plug-in	Class 8501 Type K	23-9
Square D® Alternating Plug-in	Class 8501 Type KA	23-10
Square D® Miniature Plug-in	Class 8501 Type R	23-11
Square D® Sockets	Class 8501 Type N	23-13
Square D® Power	Class 8501 Type C	23-14

Industrial Relays

TeSys® IEC Style Relays	TeSys D	23-15
	TeSys K	23-18
	TeSys SK	23-20
TeSys® IEC Style - Alternating Relays	CA2SKE	23-20
Square D® NEMA Style Relays	Class 8501 Type X®	23-21

New! **Solid State Relays**

Panel Mount	SSRP	23-43
DIN Mount	SSRD	23-43
SSR Accessories	SSRAH1, SSRAT1	23-43

Timers

Zelio® IEC Style—17.9 mm	RE11	23-24
Zelio® Panel Mounting	RE48	23-24
Zelio® Miniature Plug-in	REXL	23-24
Zelio® IEC Style—22.5 mm	RE7, RE8, and RE9	23-25
Square D® General Purpose Plug-in	Class 9050 Type JCK	23-28
Square D® Pneumatic	Class 9050 Types A and H	23-29

Control and Measurement Relays

<i>New!</i> Zelio® Temperature Controllers—24x48	REG24	23-44
Zelio® Temperature Controllers—48x48	REG48	23-44
Zelio® Temperature Controllers—48x96	REG96	23-44
Zelio® Current Measurement Relays	RM17JC and RM35JA	23-30
Zelio® Voltage Measurement Relays	RM17U and RM35U	23-32
Zelio® Phase Measurement Relays	RM17T and RM35T	23-31
Zelio® Level Control Relays	RM35L	23-33
Zelio Pump Control Relays	RM35BA	23-33
Zelio® Speed Control Relays	RM35S	23-34
Zelio® Frequency Control Relays	RM35HZ	23-34
Zelio® Temperature Control Relays	RM35AT	23-34
Square D® Phase Failure Relays	Class 8430 Type MP	23-35
Zelio® Count Counters	RC87610	23-36

Other Products

<i>New!</i> Phaseo® DC Power Supplies	ABL1, ABL7, and ABL8	23-37
Zelio® Analog Interface Modules	RM	23-38
Zelio® Logic 2 Smart Relays	SR2, SR3	23-39
Zelio® Solid-State Interface Modules	ABS	23-41
Zelio® Electromechanical Interface Modules	ABR	23-42

Zelio® Plug-In Relays

Zelio RXM plug-in relays and sockets provide a comprehensive selection of relays responding to the most demanding standards ranging from 3A to 12A. Some of the features include:

- Spring return test button for testing the contacts (standard)
- Green LED indication of relay status (depending on version)

- Mechanical indication of relay status (standard)
- Plug-in protection module to protect against electrical spikes
- Plug-in jumper bars for coil terminals to avoid time-consuming wiring



RXM2AB1F7

Table 23.1: Miniature relays without LED (sold in lots of 10)

Coil Voltage	Number and type of contacts - Thermal current (Ith)					
	2 C/O - 12 A Res.		3 C/O - 10 A Res.		4 C/O - 8 A Res.	
	Catalog Number	\$ Price ea.	Catalog Number	\$ Price ea.	Catalog Number	\$ Price ea.
12 Vdc	RXM2AB1JD	6.30	RXM3AB1JD	6.80	RXM4AB1JD	7.10
24 Vdc	RXM2AB1BD	6.30	RXM3AB1BD	6.80	RXM4AB1BD	7.10
48 Vdc	RXM2AB1ED	6.30	RXM3AB1ED	6.80	RXM4AB1ED	7.10
110 Vdc	RXM2AB1FD	6.30	RXM3AB1FD	6.80	RXM4AB1FD	7.10
220 Vdc	—	—	—	—	RXM4AB1MD	7.10
24 Vac	RXM2AB1B7	6.30	RXM3AB1B7	6.80	RXM4AB1B7	7.10
48 Vac	RXM2AB1E7	6.30	RXM3AB1E7	6.80	RXM4AB1E7	7.10
120 Vac	RXM2AB1F7	6.30	RXM3AB1F7	6.80	RXM4AB1F7	7.10
230 Vac	RXM2AB1P7	6.30	RXM3AB1P7	6.80	RXM4AB1P7	7.10
240 Vac	—	—	—	—	RXM4AB1U7	7.10

Table 23.2: Miniature relays with LED (sold in lots of 10)

Coil Voltage	Number and type of contacts - Thermal current (Ith)					
	2 C/O - 12 A Res.		3 C/O - 10 A Res.		4 C/O - 8 A Res.	
	Catalog Number	\$ Price ea.	Catalog Number	\$ Price ea.	Catalog Number	\$ Price ea.
12 Vdc	RXM2AB2JD	7.40	RXM3AB2JD	7.80	RXM4AB2JD	8.10
24 Vdc	RXM2AB2BD	7.40	RXM3AB2BD	7.80	RXM4AB2BD	8.10
48 Vdc	RXM2AB2ED	7.40	RXM3AB2ED	7.80	RXM4AB2ED	8.10
110 Vdc	RXM2AB2FD	7.40	RXM3AB2FD	7.80	RXM4AB2FD	8.10
125 Vdc	—	—	—	—	RXM4AB2GD	8.10
24 Vac	RXM2AB2B7	7.40	RXM3AB2B7	7.80	RXM4AB2B7	8.10
48 Vac	RXM2AB2E7	7.40	RXM3AB2E7	7.80	RXM4AB2E7	8.10
120 Vac	RXM2AB2F7	7.40	RXM3AB2F7	7.80	RXM4AB2F7	8.10
230 Vac	RXM2AB2P7	7.40	RXM3AB2P7	7.80	RXM4AB2P7	8.10

Table 23.3: Miniature relays with LED without Push Button (sold in lots of 10)

Coil Voltage	Number and type of contacts - Thermal current (Ith)					
	2 C/O - 12 A Res.		3 C/O - 10 A Res.		4 C/O - 8 A Res.	
	Catalog Number	\$ Price ea.	Catalog Number	\$ Price ea.	Catalog Number	\$ Price ea.
12 Vdc	RXM2AB3JD	6.80	—	—	RXM4AB3JD	7.50
24 Vdc	RXM2AB3BD	6.80	—	—	RXM4AB3BD	7.50
48 Vdc	RXM2AB3ED	6.80	—	—	RXM4AB3ED	7.50
110 Vdc	RXM2AB3FD	6.80	—	—	RXM4AB3FD	7.50
125 Vdc	—	—	—	—	RXM4AB3GD	7.50
24 Vac	RXM2AB3B7	6.80	—	—	RXM4AB3B7	7.50
48 Vac	RXM2AB3E7	6.80	—	—	RXM4AB3E7	7.50
120 Vac	RXM2AB3F7	6.80	—	—	RXM4AB3F7	7.50
230 Vac	RXM2AB3P7	6.80	—	—	RXM4AB3P7	7.50

Table 23.4: Miniature relays with low level contacts, without LED (sold in lots of 10)

Number and type of contacts - Thermal current (Ith)		
4 C/O - 3 A Res.		
Coil Voltage	Catalog Number	\$ Price ea.
12 Vdc	RXM4GB1JD	7.10
24 Vdc	RXM4GB1BD	7.10
48 Vdc	RXM4GB1ED	7.10
110 Vdc	RXM4GB1FD	7.10
24 Vac	RXM4GB1B7	7.10
48 Vac	RXM4GB1E7	7.10
120 Vac	RXM4GB1F7	7.10
230 Vac	RXM4GB1P7	7.10

Table 23.6: Miniature relays with low level contacts, with LED without Push Button (sold in lots of 10)

Number and type of contacts - Thermal current (Ith)		
4 C/O - 3 A Res.		
Coil Voltage	Catalog Number	\$ Price ea.
12 Vdc	RXM4GB3JD	7.50
24 Vdc	RXM4GB3BD	7.50
48 Vdc	RXM4GB3ED	7.50
110 Vdc	RXM4GB3FD	7.50
125 Vdc	—	—
24 Vac	RXM4GB3B7	7.50
48 Vac	RXM4GB3E7	7.50
120 Vac	RXM4GB3F7	7.50
230 Vac	RXM4GB3P7	7.50

Table 23.5: Miniature relays with low level contacts, with LED (sold in lots of 10)

Number and type of contacts - Thermal current (Ith)		
4 C/O - 3 A Res.		
Coil Voltage	Catalog Number	\$ Price ea.
12 Vdc	RXM4GB2JD	8.10
24 Vdc	RXM4GB2BD	8.10
48 Vdc	RXM4GB2ED	8.10
110 Vdc	RXM4GB2FD	8.10
24 Vac	RXM4GB2B7	8.10
48 Vac	RXM4GB2E7	8.10
120 Vac	RXM4GB2F7	8.10
230 Vac	RXM4GB2P7	8.10
240 Vac	RXM4GB2U7	8.10

Approvals for Relays:

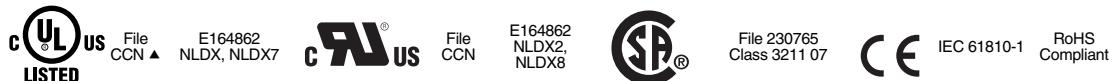

▲ When used with the appropriate socket.

For sockets and accessories, see page 23-3



RXM4GB2F7



RXZE2M114M with Relay RXM4AB2P7TQ

Table 23.7: Miniature relays (sold in lots of 100)

Coil Voltage	Number and type of contacts - Thermal current (Ith)			
	2 C/O - 12 A Res.		4 C/O - 8 A Res.	
	Catalog Number	\$ Price ea.	Catalog Number	\$ Price ea.
Without LED				
12 Vdc	—	—	RXM4AB1JDTQ	7.10
24 Vdc	RXM2AB1BDTQ	6.30	RXM4AB1BDTQ	7.10
48 Vdc	—	—	RXM4AB1EDTQ	7.10
110 Vdc	—	—	RXM4AB1FDTQ	7.10
220 Vdc	—	—	RXM4AB1MDTQ	7.10
24 Vac	RXM2AB1B7TQ	6.30	RXM4AB1B7TQ	7.10
48 Vac	—	—	RXM4AB1E7TQ	7.10
120 Vac	RXM2AB1F7TQ	6.30	RXM4AB1F7TQ	7.10
230 Vac	RXM2AB1P7TQ	6.30	RXM4AB1P7TQ	7.10
With LED				
24 Vdc	—	—	RXM4AB2BDTQ	8.10
24 Vac	RXM2AB2B7TQ	7.40	RXM4AB2B7TQ	8.10
230 Vac	RXM2AB2P7TQ	7.40	RXM4AB2P7TQ	8.10

Table 23.8: Miniature relays with LED without Push Button (sold in lots of 100)

Coil Voltage	Number and type of contacts - Thermal current (Ith)			
	2 C/O - 12 A Res.		4 C/O - 8 A Res.	
	Catalog Number	\$ Price ea.	Catalog Number	\$ Price ea.
24 Vdc	RXM2AB3BDTQ	6.80	RXM4AB3BDTQ	7.50
24 Vac	RXM2AB3B7TQ	6.80	RXM4AB3B7TQ	7.50
230 Vac	RXM2AB3P7TQ	6.80	RXM4AB3P7TQ	7.50

Table 23.9: Sockets (sold in lots of 10)

Contact terminal arrangement	Connection	Relay type	Catalog Number	\$ Price ea.
Mixed	Screw clamp terminals	RXM2****▲ RXM4****▲	RXZE2M114■	5.90
	Box lug connector	RXM2**** RXM4****	RXZE2M114M■	5.90
Separate	Box lug connector	RXM2****	RXZE2S108M◆	5.90
		RXM3****	RXZE2S111M■	5.90
		RXM4****	RXZE2S114M■	5.90

- ▲ When mounting relay RXM2**** on socket RXZE2M****, the thermal current must not exceed 10 A.
- Thermal current Ith: 10 A
- ◆ Thermal current Ith: 12 A



RXZE2S114M with relay RXM4AB2F7TQ

Table 23.10: Protection modules (sold in lots of 20)

Description	Voltage	For use with	Catalog Number	\$ Price ea.
Diode	6-250 Vdc	All sockets	RXM040W	2.30
RC circuit	24-60 Vac	All sockets	RXM041BN7	2.30
	110-240 Vac	All sockets	RXM041FU7	2.30
Varistor	6-24 Vac/Vdc	All sockets	RXM021RB	2.30
	24-60 Vac/Vdc	All sockets	RXM021BN	2.30
	110-240 Vac/Vdc	All sockets	RXM021FP	2.30

Table 23.11: Accessories (sold in lots of 10)

Description	For use with	Catalog Number	\$ Price ea.
Metal hold-down clip	All sockets	RXZ400	.57
Plastic hold-down clip	All sockets	RXZR335	.57
Bus jumper, 2-pole (Ith: 5 A)	All sockets with separate contacts	RXZS2	.84
Mounting adapter for DIN rail	All relays	RXZE2DA	.84
Mounting adapter for mounting directly to a panel	All relays	RXZE2FA	.57
Clip-in markers	All relays (sheet of 108 markers)	RXZL520	.05
	All sockets except RXZE2M114	RXZL420	.05



RXM041BN7



RXZ400

Approvals for Sockets:



File CCN E172326 SWIV2, SWIV8



File 230765 Class 3211 07



IEC 61810-1 RoHS Compliant

Zelio® Plug-In Relays

Zelio RPM plug-in relays and sockets provide a comprehensive selection of relays responding to the most demanding standards at 15 A. Some of the features include:

- Spring return test button for testing the contacts (standard)
- Green LED indication of relay status (depending on version)
- Mechanical indication of relay status (standard)
- Plug-in protection module to protect against electrical spikes



RPM22F7

Table 23.12: Power relays without LED (sold in lots of 10)

Coil Voltage	Number and type of contacts - Thermal current (Ith)							
	1 C/O - 15 A Res.		2 C/O - 15 A Res.		3 C/O - 15 A Res.		4 C/O - 15 A Res.	
	Catalog Number	\$ Price ea.	Catalog Number	\$ Price ea.	Catalog Number	\$ Price ea.	Catalog Number	\$ Price ea.
12 Vdc	RPM11JD	5.40	RPM21JD	7.10	RPM31JD	9.60	RPM41JD	11.90
24 Vdc	RPM11BD	5.40	RPM21BD	7.10	RPM31BD	9.60	RPM41BD	11.90
48 Vdc	RPM11ED	5.40	RPM21ED	7.10	RPM31ED	9.60	RPM41ED	11.90
110 Vdc	RPM11FD	5.40	RPM21FD	7.10	RPM31FD	9.60	RPM41FD	11.90
24 Vac	RPM11B7	5.40	RPM21B7	7.10	RPM31B7	9.60	RPM41B7	11.90
48 Vac	RPM11E7	5.40	RPM21E7	7.10	RPM31E7	9.60	RPM41E7	11.90
120 Vac	RPM11F7	5.40	RPM21F7	7.10	RPM31F7	9.60	RPM41F7	11.90
230 Vac	RPM11P7	5.40	RPM21P7	7.10	RPM31P7	9.60	RPM41P7	11.90



RPM32F7

Table 23.13: Power relays with LED (sold in lots of 10)

Coil Voltage	Number and type of contacts - Thermal current (Ith)							
	1 C/O - 15 A Res.		2 C/O - 15 A Res.		3 C/O - 15 A Res.		4 C/O - 15 A Res.	
	Catalog Number	\$ Price ea.	Catalog Number	\$ Price ea.	Catalog Number	\$ Price ea.	Catalog Number	\$ Price ea.
12 Vdc	RPM12JD	6.30	RPM22JD	8.10	RPM32JD	10.70	RPM42JD	12.90
24 Vdc	RPM12BD	6.30	RPM22BD	8.10	RPM32BD	10.70	RPM42BD	12.90
48 Vdc	RPM12ED	6.30	RPM22ED	8.10	RPM32ED	10.70	RPM42ED	12.90
110 Vdc	RPM12FD	6.30	RPM22FD	8.10	RPM32FD	10.70	RPM42FD	12.90
24 Vac	RPM12B7	6.30	RPM22B7	8.10	RPM32B7	10.70	RPM42B7	12.90
48 Vac	RPM12E7	6.30	RPM22E7	8.10	RPM32E7	10.70	RPM42E7	12.90
120 Vac	RPM12F7	6.30	RPM22F7	8.10	RPM32F7	10.70	RPM42F7	12.90
230 Vac	RPM12P7	6.30	RPM22P7	8.10	RPM32P7	10.70	RPM42P7	12.90

Table 23.14: Power relays with LED without Push Button (sold in lots of 10)

Coil Voltage	Number and type of contacts - Thermal current (Ith)							
	1 C/O - 15 A Res.		2 C/O - 15 A Res.		3 C/O - 15 A Res.		4 C/O - 15 A Res.	
	Catalog Number	\$ Price ea.	Catalog Number	\$ Price ea.	Catalog Number	\$ Price ea.	Catalog Number	\$ Price ea.
12 Vdc	RPM13JD	5.90	RPM23JD	7.50	RPM33JD	9.90	RPM43JD	12.00
24 Vdc	RPM13BD	5.90	RPM23BD	7.50	RPM33BD	9.90	RPM43BD	12.00
48 Vdc	RPM13ED	5.90	RPM23ED	7.50	RPM33ED	9.90	RPM43ED	12.00
110 Vdc	RPM13FD	5.90	RPM23FD	7.50	RPM33FD	9.90	RPM43FD	12.00
125 Vdc	—	—	—	—	—	—	—	—
24 Vac	RPM13B7	5.90	RPM23B7	7.50	RPM33B7	9.90	RPM43B7	12.00
48 Vac	RPM13E7	5.90	RPM23E7	7.50	RPM33E7	9.90	RPM43E7	12.00
120 Vac	RPM13F7	5.90	RPM23F7	7.50	RPM33F7	9.90	RPM43F7	12.00
230 Vac	RPM13P7	5.90	RPM23P7	7.50	RPM33P7	9.90	RPM43P7	12.00

Approvals for relays:

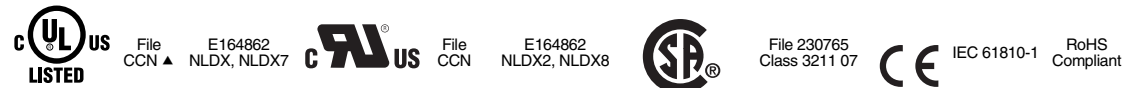

▲ When used with the appropriate socket



RPZF2 + relay RPM22F7

Table 23.15: Sockets (sold in lots of 10)

Contact terminal arrangement	Connection	Relay type	Catalog Number	\$ Price ea.
Mixed	Screw clamp terminals	RPM1 [~]	RPZF1	5.10
		RPM2 [~]	RPZF2	6.50
		RPM3 [~]	RPZF3	7.50
		RPM4 [~]	RPZF4	8.70

Approvals for Sockets:





RXM041BN7

Table 23.16: Protection modules

Description	Voltage	For use with	Sold in lots of	Catalog Number	\$ Price ea.
Diode	6–250 Vdc	RPZF1 RPZF2	20	RXM040W	2.30
		RPZF3 RPZF4	10	RUW240BD	2.60
RC circuit	24–60 Vac	RPZF1 RPZF2	20	RXM041BN7	2.30
	110–240 Vac	RPZF1 RPZF2	20	RXM041FU7	2.60
		RPZF3 RPZF4	10	RUW241P7	2.60
Varistor	6–24 Vac/Vdc	RPZF1 RPZF2	20	RXM021RB	2.30
	24–60 Vac/Vdc	RPZF1 RPZF2	20	RXM021BN	2.30
	110–240 Vac/Vdc	RPZF1 RPZF2	20	RXM021FP	2.30
	24 Vac/Vdc	RPZF3 RPZF4	10	RUW242B7	3.20
	240 Vac/Vdc	RPZF3 RPZF4	10	RUW242P7	3.20



RPZ1DA

Table 23.17: Timer module▲ (sold in lots of 1)

Description	Voltage	Socket Type	Catalog Number	\$ Price
On-delay timer, interval timer, repeat cycle timer/starting on-delay, repeat cycle timer/starting off-delay, off-delay timer, one-shot timer, timing on de-energization, on-delay timer	24–240 Vac/Vdc	RPZF3 RPZF4	RUW101MW	56.00

▲ See timer module description (selection of functions and time delays) in catalog 8501CT0601.

Table 23.18: Accessories (sold in lots of 10)

Description	For use with	Catalog Number	\$ Price ea.
Metal hold-down clip (for single-pole relays)	RPZF1	RPZR235	0.60
Mounting adapters for DIN rail ■	RPM1 ^{***}	RPZ1DA	0.80
	RPM2 ^{***}	RXZE2DA	0.80
	RPM3 ^{***}	RPZ3DA	0.80
	RPM4 ^{***}	RPZ4DA	0.80
	RPM1 ^{***}	RPZ1FA	0.60
Mounting adapters for mounting directly to a panel	RPM2 ^{***}	RXZE2FA	0.60
	RPM3 ^{***}	RPZ3FA	0.60
	RPM4 ^{***}	RPZ4FA	0.60
Clip-in markers (sheet of 108 markers)	All relays	RXZL520	0.05

■ Test button becomes inaccessible



RPZ3FA

Zelio® Plug-In Relays

Zelio RUM plug-in relays and sockets provide a comprehensive selection of relays responding to the most demanding standards at 10 A. Some of the features include:

- Spring return test button for testing the contacts (standard)
- Green LED indication of relay status (depending on version)
- Mechanical indication of relay status (standard)
- Plug-in protection module to protect against electrical spikes
- Plug-in jumper bars for coil terminals to avoid time-consuming wiring



RUMC2AB1BD

Table 23.19: Relays for standard applications, without LED (sold in lots of 10)

Pins	Coil Voltage	Number and type of contacts - Thermal current (Ith)			
		2 C/O -16 A Res.		3 C/O -16 A Res.	
		Catalog Number	\$ Price ea.	Catalog Number	\$ Price ea.
Cylindrical	12 Vdc	RUMC2AB1JD	12.00	RUMC3AB1JD	13.40
	24 Vdc	RUMC2AB1BD	12.00	RUMC3AB1BD	13.40
	48 Vdc	RUMC2AB1ED	12.00	RUMC3AB1ED	13.40
	60 Vdc	—	—	RUMC3AB1ND	13.40
	110 Vdc	RUMC2AB1FD	12.00	RUMC3AB1FD	13.40
	125 Vdc	—	—	RUMC3AB1GD	13.40
	220 Vdc	—	—	RUMC3AB1MD	13.40
	24 Vac	RUMC2AB1B7	12.00	RUMC3AB1B7	13.40
	48 Vac	RUMC2AB1E7	12.00	RUMC3AB1E7	13.40
	120 Vac	RUMC2AB1F7	12.00	RUMC3AB1F7	13.40
	230 Vac	RUMC2AB1P7	12.00	RUMC3AB1P7	13.40
	Flat	12 Vdc	RUMF2AB1JD	12.00	RUMF3AB1JD
24 Vdc		RUMF2AB1BD	12.00	RUMF3AB1BD	13.40
48 Vdc		RUMF2AB1ED	12.00	RUMF3AB1ED	13.40
110 Vdc		RUMF2AB1FD	12.00	RUMF3AB1FD	13.40
24 Vac		RUMF2AB1B7	12.00	RUMF3AB1B7	13.40
48 Vac		RUMF2AB1E7	12.00	RUMF3AB1E7	13.40
120 Vac		RUMF2AB1F7	12.00	RUMF3AB1F7	13.40
230 Vac		RUMF2AB1P7	12.00	RUMF3AB1P7	13.40

Table 23.20: Relays for standard applications, with LED (sold in lots of 10)

Pins	Coil Voltage	Number and type of contacts - Thermal current (Ith)				
		2 C/O -16 A Res.		3 C/O -16 A Res.		
		Catalog Number	\$ Price ea.	Catalog Number	\$ Price ea.	
Cylindrical	12 Vdc	RUMC2AB2JD	13.40	RUMC3AB2JD	14.90	
	24 Vdc	RUMC2AB2BD	13.40	RUMC3AB2BD	14.90	
	48 Vdc	RUMC2AB2ED	13.40	RUMC3AB2ED	14.90	
	60 Vdc	—	—	RUMC3AB2ND	14.90	
	110 Vdc	RUMC2AB2FD	13.40	RUMC3AB2FD	14.90	
	125 Vdc	—	—	RUMC3AB2GD	14.90	
	24 Vac	RUMC2AB2B7	13.40	RUMC3AB2B7	14.90	
	48 Vac	RUMC2AB2E7	13.40	RUMC3AB2E7	14.90	
	120 Vac	RUMC2AB2F7	13.40	RUMC3AB2F7	14.90	
	230 Vac	RUMC2AB2P7	13.40	RUMC3AB2P7	14.90	
	Flat	12 Vdc	RUMF2AB2JD	13.40	RUMF3AB2JD	14.90
		24 Vdc	RUMF2AB2BD	13.40	RUMF3AB2BD	14.90
48 Vdc		RUMF2AB2ED	13.40	RUMF3AB2ED	14.90	
110 Vdc		RUMF2AB2FD	13.40	RUMF3AB2FD	14.90	
24 Vac		RUMF2AB2B7	13.40	RUMF3AB2B7	14.90	
48 Vac		RUMF2AB2E7	13.40	RUMF3AB2E7	14.90	
120 Vac		RUMF2AB2F7	13.40	RUMF3AB2F7	14.90	
230 Vac		RUMF2AB2P7	13.40	RUMF3AB2P7	14.90	

Table 23.21: Relays for standard applications, with LED without Push Button (sold in lots of 10)

Pins	Coil Voltage	Number and type of contacts - Thermal current (Ith)				
		2 C/O -16 A Res.		4 C/O -16 A Res.		
		Catalog Number	\$ Price ea.	Catalog Number	\$ Price ea.	
Cylindrical	12 Vdc	RUMC2AB3JD	12.40	RUMC3AB3JD	13.90	
	24 Vdc	RUMC2AB3BD	12.40	RUMC3AB3BD	13.90	
	48 Vdc	RUMC2AB3ED	12.40	RUMC3AB3ED	13.90	
	60 Vdc	—	—	RUMC3AB3ND	13.90	
	110 Vdc	RUMC2AB3FD	12.40	RUMC3AB3FD	13.90	
	125 Vdc	—	—	RUMC3AB3GD	13.90	
	24 Vac	RUMC2AB3B7	12.40	RUMC3AB3B7	13.90	
	48 Vac	RUMC2AB3E7	12.40	RUMC3AB3E7	13.90	
	120 Vac	RUMC2AB3F7	12.40	RUMC3AB3F7	13.90	
	230 Vac	RUMC2AB3P7	12.40	RUMC3AB3P7	13.90	
	Flat	12 Vdc	RUMF2AB3JD	12.40	RUMF3AB3JD	13.90
		24 Vdc	RUMF2AB3BD	12.40	RUMF3AB3BD	13.90
48 Vdc		RUMF2AB3ED	12.40	RUMF3AB3ED	13.90	
110 Vdc		RUMF2AB3FD	12.40	RUMF3AB3FD	13.90	
125 Vdc		—	—	RUMF3AB3GD	13.90	
24 Vac		RUMF2AB3B7	12.40	RUMF3AB3B7	13.90	
48 Vac		RUMF2AB3E7	12.40	RUMF3AB3E7	13.90	
120 Vac		RUMF2AB3F7	12.40	RUMF3AB3F7	13.90	
230 Vac		RUMF2AB3P7	12.40	RUMF3AB3P7	13.90	

Approvals for Relays:

▲ When used with appropriate socket

For sockets and accessories, see page 23-7



RUZ C3M + RUMC3AB3BD (relay)

Table 23.22: Sockets (sold in lots of 10)

Contact terminal arrangement	Connection	Relay type	Catalog Number	\$ Price ea.
Mixed ▲	Box lug connector	RUMC2****	RUZC2M	4.20
		RUMC3****	RUZC3M	5.00
RUMC2****		RUZSC2M	5.40	
RUMC3****		RUZSC3M	5.90	
Separate ■		RUMF2****	RUZSF3M	6.60
		RUMF3****		

▲ The inputs are mixed with the relay coil terminals, with the outputs located on the opposite side of the socket.
■ The inputs and outputs are separated from the relay coil terminals.

Table 23.23: Protection modules (sold in lots of 10)

Description	For use with	Voltage	Catalog Number	\$ Price ea.
Diode	All sockets	6–250 Vdc	RUW240BD	2.60
RC circuit		110–240 Vac	RUW241P7	2.60
Varistor		24 Vac/Vdc	RUW242B7	4.70
		240 Vac/Vdc	RUW242P7	4.70

Table 23.24: Timer module (sold in lots of 1)

Description	For use with	Voltage	Catalog Number	\$ Price
On-delay timer, interval timer, repeat cycle timer/starting on-delay, repeat cycle timer/starting off-delay, off-delay timer, one-shot timer, timing on de-energization, on-delay timer.	All sockets	24–240 Vac/Vdc	RUW101MW	56.00

♦ See timer module description (selection of functions and time delays) in catalog 8501CT0601.

Table 23.25: Accessories (sold in lots of 10)

Description	For use with	Catalog Number	\$ Price ea.
Metal hold-down clip	All sockets	RUZC200	1.40
Bus jumper, 2-pole (Ith: 5 A)	All sockets with separate contacts	RUZS2	0.80
Clip-in markers	All relays (sheet of 108 markers)	RXZL520	0.05
	All sockets with separate contacts	RUZ420	0.05



RUW241P7



RUW101MW



RUZS2



RUZC200

Approvals for Sockets:



File CCN E172326 SWIV2, SWIV8



File Class 230765 3211 07



IEC 61810-1

RoHS Compliant

Zelio® RPF Power Relays

RPF Zelio plug-in power relays respond to the most demanding standards at 30 A. Some of the features include:

- Output contacts—four or six flat pins
- Coil terminals—two flat pins
- Locating slot for mounting on DIN rail
- Two mounting holes for panel mounting



RPF2AJD

Table 23.26: Power relays (sold in lots of 10)

Coil Voltage	Number and type of contacts - Thermal current (Ith)			
	2 N/O - 30 A ▲ Res.		2 C/O - 30 A on N.O. / 3 A on N.C. ▲ Res.	
	Catalog Number	\$ Price ea.	Catalog Number	\$ Price ea.
12 Vdc	RPF2AJD	12.30	RPF2BJD	12.90
24 Vdc	RPF2ABD	12.30	RPF2BBD	12.90
110 Vdc	RPF2AFD	12.30	RPF2BFD	12.90
24 Vac	RPF2AB7	12.30	RPF2BB7	12.90
120 Vac	RPF2AF7	12.30	RPF2BF7	12.90
230 Vac	RPF2AP7	12.30	RPF2BP7	12.90

▲ 30 A when mounted with 13 mm gap between two relays.
25 A when mounted side by side without a gap.

Approvals for Relays:



File CCN E43641 NLDX, NLDX7



File Class 040787 3211-07



IEC 61810-1

RoHS Compliant

For mounting track, see page 24-16

Zelio® Plug-In Relays

Zelio RSB plug-in relays and sockets provide a comprehensive selection of relays responding to the most demanding standards at 8 A, 12 A, and 16 A. Some of the features include:

- Plug-in protection module available to protect against electrical spikes
- Socket or printed circuit board installation

Table 23.27: Relays for standard applications
(sold in lots of 10)

Coil Voltage	Number and type of contacts - Thermal current (Ith)					
	1 C/O -12 A Res.		1 C/O -16 A Res.		2 C/O -8 A Res.	
	Catalog Number▲	\$ Price ea.	Catalog Number▲	\$ Price ea.	Catalog Number▲	\$ Price ea.
6 Vdc	RSB1A120RD	4.20	RSB1A160RD	5.00	RSB2A080RD	5.00
12 Vdc	RSB1A120JD	4.20	RSB1A160JD	5.00	RSB2A080JD	5.00
24 Vdc	RSB1A120BD	4.20	RSB1A160BD	5.00	RSB2A080BD	5.00
48 Vdc	RSB1A120ED	4.20	RSB1A160ED	5.00	RSB2A080ED	5.00
60 Vdc	RSB1A120ND	4.20	RSB1A160ND	5.00	RSB2A080ND	5.00
110 Vdc	RSB1A120FD	4.20	RSB1A160FD	5.00	RSB2A080FD	5.00
24 Vac	RSB1A120B7	4.20	RSB1A160B7	5.00	RSB2A080B7	5.00
48 Vac	RSB1A120E7	4.20	RSB1A160E7	5.00	RSB2A080E7	5.00
120 Vac	RSB1A120F7	4.20	RSB1A160F7	5.00	RSB2A080F7	5.00
220 Vac	RSB1A120M7	4.20	RSB1A160M7	5.00	RSB2A080M7	5.00
230 Vac	RSB1A120P7	4.20	RSB1A160P7	5.00	RSB2A080P7	5.00
240 Vac	RSB1A120U7	4.20	RSB1A160U7	5.00	RSB2A080U7	5.00

▲ To order a relay complete with socket (sold in lots of 20): add suffix S to the catalog numbers selected above.
Example: RSB 2A080RD + RSZ E1S48M becomes RSB 2A080RDS.

Table 23.28: Sockets – 12 A, 300 Vac
(sold in lots of 10)

Contact terminal arrangement	Connection	Relay type	Catalog Number	\$ Price ea.
Separate	Box lug connector	RSB1A120**	RSZE1S35M	5.70
		RSB1A160**■	RSZE1S48M	6.30
		RSB2A080**		

■ When using the relay with socket RSZ E1S48M, terminals must be jumpered.

Table 23.29: Protection modules (sold in lots of 10)

Description	For use with	Voltage	Catalog Number	\$ Price ea.
Diode	All sockets	6–230 Vdc	RZM040W	2.90
		24–60 Vac	RZM041BN7	5.70
RC circuit	All sockets	110–240 Vac	RZM041FU7	5.70
		6–24 Vdc	RZM031RB	5.00
Diode + green LED	All sockets	24–60 Vdc	RZM031BN	5.00
		110–230 Vdc	RZM031FPD	7.10
Varistor + green LED	All sockets	6–24 Vac/Vdc	RZM021RB	7.10
		24–60 Vac/Vdc	RZM021BN	7.10
		110–230 Vac/Vdc	RZM021FP	7.10

Table 23.30: Accessories (sold in lots of 10)

Description	For use with	Catalog Number	\$ Price ea.
Plastic hold-down clip	All sockets	RSZR215	.42
Marker	All sockets	RSZL300	.29

Approvals for RSB relays:

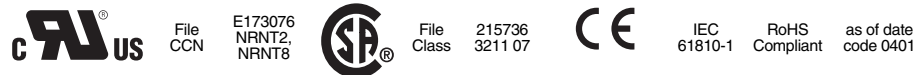

Approvals for RSB sockets:

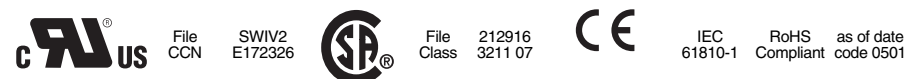

RZM modules are RoHS compliant as of date code 0610.

For mounting track, see page 24-16.



RSB1A120JD
+ RZM031FPD
+ RSZE1S35M



RSB2A080BD
+ RSZE1S48M



RSB1A160BD
+ RSZE1S48M

by Schneider Electric
www.schneider-electric.us

Class 8501 / Refer to Catalog 8501CT0301

Square D® Plug-In Relays

8501K relays are designed for multipole switching applications at 240 volts or lower. These relays have industry standard wiring and pin arrangements which allows for their use as replacements for many similar relays without wiring or hardware modifications.

- 12 A relays
- DPDT or 3PDT
- Manual operator/
green pilot light options
- Horsepower rated
- DPDT latching relay
- AC or DC operation
- RoHS Compliant

Pilot Light Option—Available on Types KP and KU. Internal pilot lights are available in both AC and DC versions for positive indication of power to the coil. The pilot light is a green LED.

Manual Operator Option—Available on Type KU only. To speed circuit testing, a manual operator can be provided. With this feature the relay can be manually switched to simulate normal operation.

Coil VAC—3.0 VA

Coil VDC—1.4 Watts

Table 23.31: Type KF▲ —Flange Mounted—Spade Terminals

	Input Voltage	Contact Arrangement	Options	Type	\$ Price
	AC 50/60 Hz	DPDT	None Available	KF12■	24.60
		3PDT		KF13■	26.70
	DC	DPDT	None Available	KFD12■	24.60
		3PDT		KFD13■	26.70

▲ Socket is not required with Type KF relays.

Table 23.34: Type KP—Tubular Terminals

	Input Voltage	Contact Arrangement	Options	Type	\$ Price
	AC 50/60 Hz	DPDT	None	KP12■	39.00
		DPDT	Pilot Light	KP12P14■	45.00
		3PDT	None	KP13■	47.30
		3PDT	Pilot Light	KP13P14■	53.30
	DC	DPDT	None	KPD12■	39.00
		DPDT	Pilot Light	KPD12P14■	45.00
		3PDT	None	KPD13■	47.30
		3PDT	Pilot Light	KPD13P14■	53.30

Table 23.32: Type KL—Latching Relay—Spade Terminals

	Input Voltage	Contact Arrangement	Options	Type	\$ Price
	AC 50/60 Hz	DPDT	None Available	KL12■	45.00
	DC	DPDT	None Available	KLD12■	45.00

Table 23.35: Type KU—Spade Terminals

	Input Voltage	Contact Arrangement	Options	Type	\$ Price	
	AC 50/60 Hz	DPDT	None	KU12■	22.70	
		DPDT	Manual Operator	KU12M1■	26.70	
		DPDT	Pilot Light	KU12P14■	28.70	
		DPDT	Manual Operator and Pilot Light	KU12M1P14■	30.80	
		3PDT	None	KU13■	24.60	
		3PDT	Manual Operator	KU13M1■	28.70	
		3PDT	Pilot Light	KU13P14■	30.80	
		3PDT	Manual Operator and Pilot Light	KU13M1P14■	35.00	
		DC	DPDT	None	KUD12■	22.70
			DPDT	Manual Operator	KUD12M1■	26.70
			DPDT	Pilot Light	KUD12P14■	28.70
			DPDT	Manual Operator and Pilot Light	KUD12M1P14■	30.80
	3PDT		None	KUD13■	24.60	
	3PDT		Manual Operator	KUD13M1■	28.70	
	3PDT	Pilot Light	KUD13P14■	30.80		
	3PDT	Manual Operator and Pilot Light	KUD13M1P14■	35.00		

Table 23.33: Voltage Codes and Stocked Relays

Type	AC Voltage 50/60 Hz					Type	DC Voltage					
	6	12	24	120	240		6	12	24	48	110	125
Voltage Codes	V35	V36	V14	V20	V24	Voltage Codes	V50	V51	V53	V56	V60	V63
KP12	S	S	S	S	S	KPD12	S	S	S	S	S	S
KP12P14		S	S	S	S	KPD12P14		S	S		S	S
KP13		S	S	S	S	KPD13		S	S	S	S	S
KP13P14			S	S	S	KPD13P14			S			
KU12		S	S	S	S	KUD12		S				
KU12M1						KUD12M1			S			
KU12P14			S	S		KUD12P14			S			
KU12M1P14			S	S		KUD12M1P14			S			
KU13		S	S	S	S	KUD13		S	S		S	
KU13M1						KUD13M1						
KU13P14			S	S		KUD13P14						
KU13M1P14			S	S	S	KUD13M1P14			S		S	
KF12			S	S	S	KFD12		S	S			
KF13			S	S		KFD13			S			
KL12			S	S	S	KLD12		S	S			

Note: S = Stocked.

Factory order items require a minimum order quantity of 25 and have a lead time of 12 weeks.

- Voltage code must be specified to order this product. Refer to standard voltage codes listed in Table 23.33 and insert as shown in Table 23.37: How to Order.

For 8501 KP, KU, and KF:



For 8501 KP, KU, and KL:

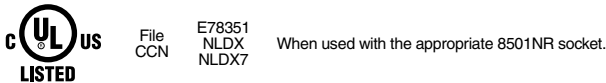

For 8501 KL:



Table 23.36: Contact Ratings (Contacts are Silver Tin Oxide)

Type	AC			DC	
	AC Volts	Resistive 75% PF Continuous Amperes	Hp	DC Volts	Resistive Amperes
KP	120	12	1/3	28	12
	240	12	1/2		
KU KF	120	12	1/3	28	12
	240	12	1/2		
KL	120	12	1/3	28	12
	240	12	1/2		

Note: All 8501 K relays have a B300 rating.

- ◆ 3 pole devices have a 20 A max. total (sum of currents in all 3 poles), continuous rating.
- ★ 3 pole devices have a 30 A max. total (sum of currents in all 3 poles), continuous rating.
- ▼ Socket is not required with Type KF relays.

Table 23.37: How to Order

To Order Specify:	Catalog Number		
• Class Number	Class	Type	Voltage Code
• Type Number			
• Voltage Code (See Stocked Relay Table above)	8501	KP12	V20

For sockets and accessories, see page 23-13.
For track, see page 24-16.



New!

Square D® Alternating Plug-In Relays

8501KA alternating relay is designed to minimize pump and motor wear by equalizing run time between parallel components in a multi-pump system.

The relay is controlled by an external control switch. The switch may be any type of contact closure; for example the contacts of a timing relay or the closure of a float switch. The 8501KA relay also has a toggle switch that allows the operator to lock one side of the duplex system in the “on” position.

- 12 amp Resistive Rating
- SPDT or DPDT
- Toggle switch for load control
- LED Load Indicators
- Horsepower Rated
- AC and DC Control
- UL Listed w/ Square D Socket
- Rohs Compliant

Table 23.38: Type KA — Alternating Relay

	Input Voltage	Contact Arrangement	Options	Type	\$ Price
	AC & DC	SPDT	LED + Toggle	8501KA81***	95.00
	AC & DC	DPDT	LED + Toggle + Cross Wired	8501KA82***	95.00
	AC & DC	DPDT (N.C.)	LED + Toggle	8501KA112***	95.00
	AC & DC	DPDT (N.O.)	LED + Toggle	8501KA112A***	95.00

Table 23.39: Relay Availability

Type	AC & DC Voltage			AC Voltage
	12	24	120	240
8501KA81***	—	—	S	—
8501KA82***	—	—	S	—
8501KA112***	—	—	S	—
8501KA112A***	—	—	S	—

Note: AC Voltage is 50/60 Hz
“S” items have a 2 week lead time and no minimum order requirement. All other part numbers require a minimum order quantity of 100 and have a lead-time of 18 weeks.

Table 23.40: Contact Ratings

Type	AC				DC	
	AC Volts	Resistive Amperes	HP	Pilot Duty	DC Volts	Resistive Amperes
8501KA81***	120	12	1/3	—	30	12
	240	12	1/2	B300		

Table 23.41: Alternating Functions

Diagram	Toggle Switch Position	Detail	S1 = Control Switch 1	S2 = Control Switch 2	LA = Load 1	LB = Load 2
A, C & D	Alternate	Closing S1 alternates the loads between LA and LB.				
	Lock 1	LA is ON and LB is OFF. S1 is not used in this mode.				
	Lock 2	LA is OFF and LB is ON. S1 is not used in this mode.				
B	Alternate	Closing S1 alternates the loads between LA and LB. S2 will only control LA.				
	Lock 1	S1 will control LA and S2 will control LB				
	Lock 2	S1 will control LB and S2 will control LA.				
ALL	The cross wired option allows extra system load capacity through simultaneous operation of both motors when needed (LA and LB energize simultaneously when both S1 and S2 are closed—relay contacts are not isolated) Input voltage must be applied at all times for proper alternation. Use of a solid state control switch for S1 or S2 may not initiate alternation correctly. S1 or S2 voltage must be from the same supply as the unit's input voltage (see wiring diagrams). Loss of input voltage resets the unit; LA becomes the lead load for the next operation.					

Wiring Diagrams and Dimensions

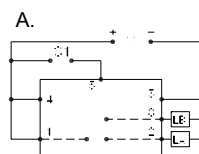

8501KA81***
Socket = 8501NR51 or NR52

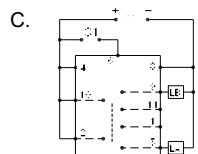

8501KA112***
Socket = 8501NR61 or NR62

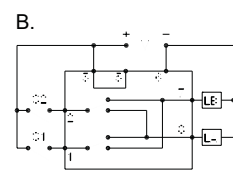
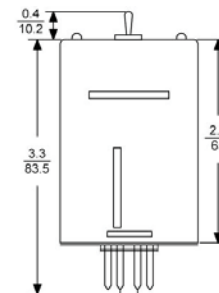
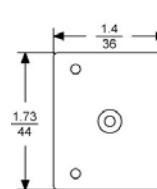

8501KA82***
Socket = 8501NR51 or NR52

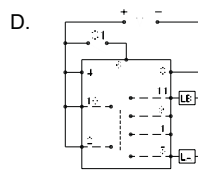

8501KA112A***
Socket = 8501NR61 or NR62

Approvals



File Class E78351 NLDX



File Class E78351 NLDX2



File Class 242675 3211-07



IEC 61810-1

Square D® Miniature Plug-in Relays



8501R miniature plug-in relays have a 10 A resistive rating, the same as the Type K plug-in relays, but are much smaller. The compact size of these relays makes them ideal for downsizing equipment.

- SPDT through 4PDT
- AC or DC operated
- Horsepower rated
- Socket compatible
- Manual operator/green LED pilot light options
- Silver tin oxide contacts

Table 23.42: Contact Ratings (Contact material is Silver Tin Oxide)

Type	Voltage	Resistive Rating	Voltage	General Use Rating	Horsepower Rating
8501RS41 ▲	120 Vac	15	120 Vac	10	1/2 @ 120 Vac
	240 Vac	10	240 Vac	10	1 @ 240 Vac
8501RSD41▲	28 Vdc	15	28 Vdc	15	—
8501RS42▲	120 Vac	10	120 Vac	10	1/3 @ 120 Vac
	240 Vac	10	240 Vac	10	1/2 @ 240 Vac
8501RSD42▲	30 Vdc	10	28 Vdc	10	—
8501RS43▲	120 Vac	12	150 Vac	10	1/2 @ 120 Vac
	240 Vac	12	250 Vac	6.6	3/4 @ 240 Vac
8501RSD43▲	28 Vdc	12	28 Vdc	10	—
8501RS44▲	120 Vac	12	150 Vac	7.5	1/2 @ 120 Vac
	277 Vac	12	250 Vac	5	3/4 @ 240 Vac
8501RSD44▲	28 Vdc	12	28 Vdc	10	—

▲ Relays have a B300 rating with UL.

Table 23.43: Voltage Codes and Stocked Relays

Type	AC Voltage 50/60 Hz					Type	DC Voltage			
	6	12	24	120	240		6	12	24	110
Voltage Code	V35	V36	V14	V20	V24	Voltage Code	V50	V51	V53	V60
RS41			S	S		RSD41		S	S	
RS41M1						RSD41M1				
RS41P14			S	S		RSD41P14			S	
RS41M1P14			S	S		RSD41M1P14			S	
RS42		S	S	S	S	RSD42		S	S	
RS42M1						RSD42M1				
RS42P14			S	S		RSD42P14		S	S	
RS42M1P14				S		RSD42M1P14			S	
RS43			S	S		RSD43			S	
RS43M1						RSD43M1				
RS43P14				S		RSD43P14				
RS43M1P14				S		RSD43M1P14				
RS44			S	S	S	RSD44		S	S	
RS44M1						RSD44M1				
RS44P14				S		RSD44P14			S	
RS44M1P14				S		RSD44M1P14				

Note: S = Stocked.

Factory order items require a **minimum** order quantity of 25 and have a lead time of 12 weeks.

Table 23.48: Application Data

Class 8501 Type	RS41	RSD41	RS42	RSD42	RS43	RSD43	RS44	RSD44	
Operating Data	Pick-Up Time	20 ms Maximum			25 ms Maximum		20 ms Maximum		
	Drop-Out Time	20 ms Maximum							
	Operating Temperature	-40°C to +70°C (-40°F to +158°F)							
Coil	Duty Cycle	Continuous							
	Voltage Range	AC coils +10%, -15% of nominal DC coils +10%, -20% of nominal							
	AC Coils-Inrush	9 VA	—	6.2 VA	—	10.3 VA	—	11.9 VA	—
	AC Coils-Sealed	1.5 VA	—	1.2 VA	—	1.7 VA	—	2.1 VA	—
	DC Coils	—	0.9 watts	—	0.9 watts	—	1.4 watts	—	1.5 watts
UR	File E78351 CCN NLDX2, NLDX8								
CSA	File 211268 Class 3218 07								
CE marked	yes								
RoHS Compliant	yes								
UL Listed	File E78351 ♦ CCN NLDX, NLDX7								

♦ When used with the appropriate 8501NR socket.

For sockets and accessories, see page 23-13.
For track, see page 24-16.

Table 23.44: SPDT with Silver Tin Oxide Contacts

	Input Voltage	Options	Type	\$ Price
	AC 50/60 Hz	None	RS41■	29.60
		Manual Operator	RS41M1■	31.70
		Pilot Light	RS41P14■	37.20
		Manual Operator and Pilot Light	RS41M1P14■	39.30
DC	None	RSD41■	29.60	
	Manual Operator	RSD41M1■	31.70	
	Pilot Light	RSD41P14■	37.20	
	Manual Operator and Pilot Light	RSD41M1P14■	29.60	

Table 23.45: DPDT with Silver Tin Oxide Contacts

	Input Voltage	Options	Type	\$ Price
	AC 50/60 Hz	None	RS42■	35.00
		Manual Operator	RS42M1■	37.10
		Pilot Light	RS42P14■	43.10
		Manual Operator and Pilot Light	RS42M1P14■	45.20
DC	None	RSD42■	35.00	
	Manual Operator	RSD42M1■	37.10	
	Pilot Light	RSD42P14■	43.10	
	Manual Operator and Pilot Light	RSD42M1P14■	45.20	

Table 23.46: 3PDT with Silver Tin Oxide Contacts

	Input Voltage	Options	Type	\$ Price
	AC 50/60 Hz	None	RS43■	39.30
		Manual Operator	RS43M1■	41.40
		Pilot Light	RS43P14■	47.60
		Manual Operator and Pilot Light	RS43M1P14■	49.90
DC	None	RSD43■	39.30	
	Manual Operator	RSD43M1■	41.40	
	Pilot Light	RSD43P14■	47.60	
	Manual Operator and Pilot Light	RSD43M1P14■	49.90	

Table 23.47: 4PDT with Silver Tin Oxide Contacts

	Input Voltage	Options	Type	\$ Price
	AC 50/60 Hz	None	RS44■	44.30
		Manual Operator	RS44M1■	46.20
		Pilot Light	RS44P14■	52.30
		Manual Operator and Pilot Light	RS44M1P14■	54.50
DC	None	RSD44■	44.30	
	Manual Operator	RSD44M1■	46.20	
	Pilot Light	RSD44P14■	52.30	
	Manual Operator and Pilot Light	RSD44M1P14■	54.50	

■ Voltage code must be specified to order this product. Refer to standard voltage codes listed in Table 23.43 and insert as shown in Table 23.49: How to Order.

Table 23.49: How to Order

To Order Specify:	Catalog Number		
• Class Number	Class	Type	Voltage Code
• Type Number			
• Voltage Code (see Table 23.43)			
	8501	RS42	V20

Square D® Miniature Plug-in Relays

8501R relays are suited for use as logic elements and power switching output devices. The short stroke motion of the armature provides long mechanical life required for high speed operation of control systems. Different contact compositions allow these relays to be used in a variety of applications. Fine silver (gold flashed) and bifurcated crossbar (gold overlay silver) are suitable for high contact reliability and low level switching requirements. Silver tin oxide is best suited for inductive loads. Hermetically sealed relays can be used in adverse environments.



8501RSD14P14V53



8501RS14M1V14



8501RSD34V51

- 1, 3, or 5 A versions
- 4PDT
- Complete socket line
- Horsepower rated
- AC or DC operation
- Manual operator/pilot light options

Table 23.50: 5 A Version

5 A	Input Voltage	Options	Type	\$ Price
For switching inductive loads	AC 50/60 Hz	None	RS14▲	32.70
		Manual Operator	RS14M1▲	35.00
		Pilot Light	RS14P14▲	40.90
		Manual Operator and Pilot Light	RS14M1P14▲	43.10
		None	RSD14▲	27.70
		Manual Operator	RSD14M1▲	30.80
Contacts: Silver Tin Oxide	DC	Pilot Light	RSD14P14▲	36.80
		Manual Operator and Pilot Light	RSD14M1P14▲	39.00

Table 23.51: 3 A Version

3 A	Input Voltage	Options	Type	\$ Price
For low level switching	AC 50/60 Hz	None	RS4▲	32.70
		Manual Operator	RS4M1▲	35.00
		Pilot Light	RS4P14▲	40.90
		Manual Operator and Pilot Light	RS4M1P14▲	43.10
		None	RSD4▲	28.70
		Manual Operator	RSD4M1▲	30.80
Contacts: Fine Silver (Gold Flashed)	DC	Pilot Light	RSD4P14▲	36.80
		Manual Operator and Pilot Light	RSD4M1P14▲	39.00

Table 23.52: 1 A Version

1 A	Input Voltage	Type	\$ Price
Best for Low Level Switching Bifurcated Silver Gold-Plated Contacts	AC 50/60 Hz	RS24▲	53.00
	DC	RSD24▲	53.00

Table 23.53: 5 A Version, Hermetically Sealed

5 A, Hermetically Sealed	Input Voltage	Type	\$ Price
5 Ampere Resistive Silver Tin Oxide Contacts Suitable for Class I Division 2 Locations	AC 50/60 Hz	RS34▲	53.00
	DC	RSD34▲	53.00

- ▲ Voltage code must be specified to order this product. Refer to standard voltage codes shown in Table 23.55.
- Do not ground the frame.

Table 23.57: Application Data

Class 8501 Type	RS4	RSD4	RS14	RSD14	RS24	RSD24	RS34	RSD34	
Operating Data	Pick-Up Time						20 ms Maximum		13 ms Max.
	Drop-Out Time						20 ms Maximum		6 ms Max.
	Operating Temperature Range						-40°C to +70°C (-40°F to +158°F)		-40°C to +70°C (-40°F to +158°F)
Coil	Duty Cycle								Continuous
	Voltage Range								AC coils +10%, -15% of nominal and DC coils +10%, -20% of nominal
	AC Coils—Sealed		1.2 VA	—	1.2 VA	—	1.2 VA	—	1.2 VA
	AC Coils—Inrush		6.2 VA	—	6.2 VA	—	6.2 VA	—	6.0 VA
	DC Coils		—	0.9 watt	—	0.9 watt	—	0.9 watt	—
Approvals	UR		File: E197072		CCN: NRNT2		N/A		
	C UR US		File: E197072		CCN: NRNT8 (Approved but not marked)		File: E196809 CCN: NQMJ2, NQMJ8		
	CSA		File: 211268		Class: 3218 07		File: 211268 Class: 3218 06		
	CE marked		Yes						
	RoHS Compliant		Yes						
UL Listed		File E78351		CCN NLDX, NLDX7★					

★ When used with the appropriate 8501 NR Socket.

For sockets and accessories, see page 23-13.

Pilot Light Option

An internal green pilot light is available in both AC and DC versions for positive indication of power to the coil.

Manual Operation Option

To speed circuit testing, a manual operator can be provided. The relay can be manually switched to simulate normal operation.

NOTE: All Type R relays with a manual operator must be used on circuits of the same polarity.

Table 23.54: Contact Ratings (Contact material is Silver Tin Oxide)

Type	Voltage	Continuous Current Rating	Horsepower Rating
RS4 ♦ RSD4♦	120/240 Vac	3	1/10
	30 Vdc	3	—
RS14♦ RSD14♦	120/240 Vac	5	1/6
	28 Vdc	5	—
RS24 RSD24	120/240 Vac	1	1/16 (2.8 FLA)
	30 Vdc	1	—
RS34 RSD34	120/240 Vac	5	—
	30 Vdc	5	—

♦ RS4/RSD4, RS14/RSD14 have NEMA C300 pilot duty rating.

Table 23.55: AC Voltage Codes and Stocked Relays

Type	AC Voltage 50/60 Hz					
	6	12	24	48	120	240
Voltage Code	V35	V36	V14	V17	V20	V24
RS4			S		S	
RS4M1					S	
RS4P14					S	
RS4M1P14					S	
RS14		S	S		S	
RS14M1					S	
RS14P14					S	
RS14M1P14					S	S
RS24					S	
RS34					S	

Table 23.56: DC Voltage Codes and Stocked Relays

Type	DC Voltage				
	6	12	24	48	110
Voltage Code	V50	V51	V53	V56	V60
RSD4		S	S		
RSD4M1					
RSD4P14			S		
RSD4M1P14			S		
RSD14		S	S		S
RSD14M1			S		
RSD14P14		S	S		S
RSD14M1P14		S	S		
RSD24			S		
RSD34		S	S		

Note: S = Stocked.

Factory Order items require a minimum order quantity of 25 and have a lead time of 12 weeks.

Square D® Sockets

8501NR sockets are designed for use with plug-in Class 8501 Type K, KA, and R relays, 8430MPS phase failure relays and 9050JCK timers. The 8501NR45 screw terminal sockets have pressure wire clamps that accept 1 or 2 #16–22 wires. All other sockets have pressure clamps that will accept 1 or 2 #12–22 wires.

The recommended tightening torque for all terminals is 7-8 lb-in.

- All devices stocked in central warehouse
- DIN track mount or direct panel mount
- Tubular sockets available in easy-to-wire single tier or double tier versions
- RoHS compliant



8501NR51



8501NR61



8501NR52



8501NR62



8501NR82

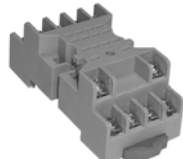

8501NR45



8501NR41



8501NR42

Table 23.58: Snapmount Sockets

For Use With Class:			Description	Socket Rating		Type	\$ Price ea.	Std. Qty.▲
8501 Type	8430 Type	9050 Type		UL	CSA			
KP12 KPD12 KA81 KA82	MPS (240 volts)	JCK11–19 JCK31–39 JCK51–59 JCK60 JCK1 F JCK3 F JCK5 F	8 Pin Tubular Single Tier Screw Terminal	600 V, 10 A 300 V, 15 A	300 V, 10 A	NR51 NR51B NR52♦	12.30 10.20 12.30	1 10 1
			8 Pin Tubular Double Tier Screw Terminal	600 V, 5 A 300 V, 16 A	300 V, 10 A	NR52♦	10.20	10
KP13 KPD13 KA112	—	JCK21–29 JCK41–49 JCK70 JCK2F JCK4F	11 Pin Tubular Single Tier Screw Terminal	600 V, 5 A 300 V, 15 A	300 V, 10 A	NR61 NR61B	18.50 16.50	1 10
			11 Pin Tubular Double Tier Screw Terminal	600 V, 5 A 300 V, 16 A	300 V, 10 A	NR62♦ NR62B♦	18.50 16.50	1 10
KL KU	MPS (480 Volts)	—	11 Pin Spade Double Tier Screw Terminal	300 V, 15 A	300 V, 15 A	NR82 NR82B	20.60 18.50	1 10
RS41 RSD41	—	—	5 Pin Spade Double Tier Screw Terminal	300 V, 15 A	300 V, 15 A	NR41♦ NR41B♦	28.70 26.70	1 10
RS42 RSD42	—	—	8 Pin Spade Double Tier Screw Terminal	300 V, 10 A	300 V, 10 A	NR42 NR42B	28.70 26.70	1 10
RS43 RSD43	—	—	11 Pin Spade Double Tier Screw Terminal	300 V, 10 A	300 V, 10 A	NR43 NR43B	26.70 26.70	1 10
RS44 RSD44	—	—	14 Pin Spade Double Tier Screw Terminal	300 V, 10 A	300 V, 10 A	NR34 NR34B	28.70 26.70	1 10
RS4 RSD4 RS14 RSD14 RS24 RSD24 RS34 RSD34	—	—	14 Pin Spade Double Tier Screw Terminal	300 V, 10 A	300 V, 10 A	NR45 NR45B	28.70 26.70	1 10

- ▲ Must be ordered in multiples of the quantity listed. Units provided in standard quantity of one are individually packaged; devices with B suffix have a standard quantity of 10 per bulk pack.
- Rated for use with Class 8430 Type MPS at 480 Volts. Rated 10 A at 300 volts by CSA.
- ♦ Finger Safe

For DIN 3 mounting track and end clamps, see page 24-16, or refer to:

- NEMA Style terminal block section of catalog 9080CT9601
- IEC Style terminal block section of catalog 9080CT9901

Table 23.59: Socket Accessories

Socket	For Use With	Description	Type	\$ Price ea.	Std. Pack ★
8501NR51	8501KP12, KPD12	Hold Down Clip	NH51	1.00	10
	8430MPSV24	Hold Down Spring	NH7	8.30	1
	9050JCK	Hold Down Spring	NH7	8.30	1
8501NR52	8501KP12, KPD12	Hold Down Clip	NH52	1.00	10
	8430MPSV24	Hold Down Spring	NH7	8.30	1
	9050JCK	Hold Down Spring	NH7	8.30	1
8501NR61	8501KP13, KPD13	Hold Down Clip	NH61	1.00	10
	9050JCK	Hold Down Spring	NH7	8.30	1
8501NR62	8501KP13, KPD13	Hold Down Clip	NH52	1.00	10
	9050JCK	Hold Down Spring	NH7	8.30	1
8501NR82	8501KU and KL	Hold Down Clip	NH82	1.00	10
	8430MPSV29	Hold Down Spring	NH7	8.30	1
8501NR41	8501RS41, RSD41	Hold Down Clip	Supplied with socket as standard	—	—
8501NR42	8501RS42, RSD42	Hold Down Clip	8501NH42	1.00	10
8501NR43	8501RS43, RSD43	Hold Down Clip	8501NH42	1.00	10
8501NR34	8501RS44, RSD44	Hold Down Clip	8501NH42	1.00	10
8501NR45	8501RS4, RSD4 8501RS14, RSD14 8501RS24, RSD24 8501RS34, RSD34	Hold Down Clip	8501NH45	1.00	10

★ Must be ordered in multiples of the quantity listed.

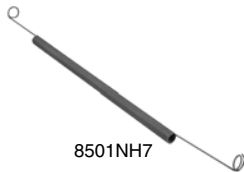

8501NH7



8501NR34

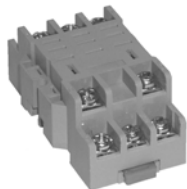

8501NR43

How to Order

To Order Specify:	Class	Type	Catalog Number
• Class Number	8501	NR51B	
• Type Number			

Approvals:



File E66924
CCN SW1V2



File Class 211268
3211 07



RoHS Compliant as of date
code 0639

IEC61810-1



8501CDO6V51

Square D® Power Relays

8501C relays are ideally suited for controlling small single phase motors and other light loads such as electric heaters, pilot lights or audible signals.

- 30 A contact rating
- Horsepower rated
- Visible contacts
- Low cost
- UL listed
- CSA certified
- CE approved

Table 23.60: Selection Table and Application Data

Selection Table							Application Data					Application Data—Coil Burden		
Contact Arrangement	Number of Fixed Contacts		AC Operated Coil Open Type		DC Operated Coil Open Type		Maximum Contact Voltage	Resistive Ampere Rating 75% Power Factor		Maximum Single Phase Horsepower			Nominal Power (Vac Coil)	Nominal DC Burden (Vdc Coil)
	N.O.	N.C.	Type	\$ Price	Type	\$ Price		300 V	600 V	120 V	230 V	600 V		
AC Rated Contacts														
SPST	1	0	CO6▲	32.70	CDO6▲	32.70	600	30	10	2	2	2	10 VA	2 W
DPST	2	0	CO7▲	51.30	CDO7▲	51.30	600	30	5	1½	1½	1½	10 VA	2 W
SPST	0	1	CO8▲	32.70	CDO8▲	32.70	600	30	10	2	2	2	10 VA	2 W
SPDT	1	1	CO15▲	57.30	CDO15▲	57.30	600	30	5	1½	1½	1½	10 VA	2 W
DPDT	2	2	CO16▲	69.60	CDO16▲	69.60	600	30	5	1½	1½	1½	10 VA	2 W
DC Rated Contacts														
							110 V	220 V						
SPST	1	0	CO21▲	71.70	CDO21▲	71.70	500	20	8	N.A.			10 VA	2 W
DPDT	2	2	CO22▲	84.00	CDO22▲	84.00	325	10	4				10 VA	2 W

▲ Voltage codes must be specified to order this product. Refer to standard voltage codes listed in Table 23.63 and insert as shown in Table 23.65: How to Order.

Table 23.61: Operating Data

Operating Voltages/Voltage Range	AC – 6 through 480 volts, + 10/-15% of nominal at 25 °C DC – 6 through 110 volts, + 10/-20% of nominal at 25 °C
Coil Inrush (Vac Coil)	15 VA
Coils	Duty: Continuous rated coils. (Non-replaceable)
Operating Temp. Range	AC: -22 °F to +122 °F (-30 °C to +50 °C) DC: -22 °F to +140 °F (-30 °C to +60 °C)

Approvals:



File E78351
CCN NLDX



File 218139
Class 3211 04



IEC 60947-4-1

Table 23.63: Voltage Codes and Stocked Relays

Class 8501 Type	AC Voltage—50/60 Hz								Class 8501 Type	DC Voltage			
	6	12	24	120	208	240	277	480		6	12	24	110
Voltage Code	V35	V36	V14	V20	V08	V24	V04	V29	Voltage Code	V50	V51	V53	V60
CO6	S	S	S	S	S	S	S	S	CDO6	S	S		
CO7	S	S	S	S	S	S	S	S	CDO7	S	S		
CO8			S	S		S	S	S	CDO8				
CO15			S	S	S	S	S	S	CDO15			S	
CO16	S	S	S	S	S	S	S	S	CDO16	S	S	S	
CO21				S					CDO21			S	S
CO22				S					CDO22			S	S

Note: S = Stocked.
Factory order items require a **minimum** order quantity of 25 and have a lead time of 12 weeks.

Approximate Dimensions

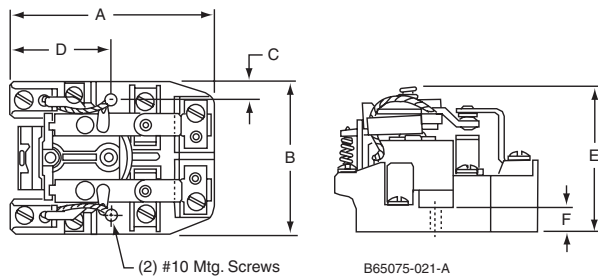

Table 23.62: Dimensions

Catalog Number 8501****	A		B		C		D		E		F	
	in.	mm	in.	mm	in.	mm	in.	mm	in.	mm	in.	mm
CO6, CO7, CO8, CDO6, CDO7, CDO8	2.43	61.7	2.50	63.5	0.31	8.0	0.81	20.6	2.25	57.2	0.37	9.5
CO15, CO21, CDO15, CDO21	2.43	61.7	2.50	63.5	0.31	8.0	0.81	20.6	2.18	55.4	0.37	9.5
CO16, CDO16	3.12	79.2	2.50	63.5	0.31	8.0	1.5	38.1	2.31	58.7	0.37	9.5
CO22, CDO22	3.12	79.2	2.50	63.5	0.31	8.0	1.5	38.1	2.53	64.3	0.37	9.5

Enclosure

NEMA 1 sheet steel enclosure



9991UE1

Table 23.64: Class 9991

Type	\$ Price
UE1	19.70

Table 23.65: How to Order

To Order Specify:	Catalog Number		
• Class Number	Class	Type	Voltage Code
• Type Number			
• Voltage Code	8501	CO6	V20
(See Stocked Relay Table above)			

TeSys® D IEC Style Relays

These 600 volt relays are approved for use around the world. TeSys D relays are usually mounted on 35 mm DIN 3 track, but can also be mounted directly to a panel. The fixed contacts in these relays have a NEMA A600 and Q600 ratings, in addition to the standard IEC ratings, making them suitable for use in most any control circuit. Low consumption versions of this relay are available for use with low level DC signals from a computer or a PLC. Adder decks can be added to a basic five pole relay to make it up to an 11 pole relay. The serrated silver-nickel contacts with wiping action provide excellent reliability in 12 or 24 volt control circuits. Special auxiliary contacts are available for switching low power down to 5 volts at 10 mA. Timer and mechanical latch attachments are available.



CAD32



CAD503



CAD323

Table 23.66: Instantaneous Control Relays

Terminal Type	Number of Contacts	Contact Composition		Catalog Number	\$ Price	
		Normally Open	Normally Closed		AC Coil	DC or Low Consumption Coil
Screw Clamp	5	5	0	CAD50▲	62.00	110.00
		3	2	CAD32▲	62.00	110.00
Spring Terminal	5	5	0	CAD503▲	62.00	110.00
		3	2	CAD323▲	62.00	110.00
Ring Tongue	5	5	0	CAD506▲	62.00	110.00
		3	2	CAD326▲	62.00	110.00

▲ Add the proper voltage code from Table 23.69 to the end of catalog number (for example, CAD50B7).

Table 23.67: Instantaneous Auxiliary Contact Blocks (for use in normal operation environments)

Number of Contacts	Maximum Number per Device Clip-on Mounting		Termination Type	Contact Composition		Catalog Number	\$ Price	
	Front	Left Side Only		Normally Open	Normally Closed			
2	1	—	Screw Clamp	2	0	LADN20	20.70	
				1	1	LADN11	20.70	
				0	2	LADN02	20.70	
	—	1 Not for DC devices	Screw Clamp	2	0	LADN203	20.70	
				1	1	LADN113	20.70	
				0	2	LADN023	20.70	
4	1	—	Screw Clamp	4	0	LADN40	41.50	
				3	1	LADN31	41.50	
				2	2	LADN22	41.50	
			Spring Terminal	1	3	LADN13	41.50	
				0	4	LADN04	41.50	
				4	0	LADN403	41.50	
	—	1	—	Spring Terminal	3	1	LADN313	41.50
					2	2	LADN223	41.50
					1	3	LADN133	41.50
				Screw Clamp	0	4	LADN043	41.50
					2	2	LADC22	41.50
					2	2	LADC223	41.50

■ Auxiliary contact blocks with four contacts cannot be used on relays with low consumption coils.

◆ Includes 1 N.O. and 1 N.C. overlapping contact.

Table 23.68: Instantaneous Auxiliary Contacts with Dust and Damp Protected Contacts (for use in particularly harsh industrial environments)

Number of Contacts	Maximum Number per Device	Contact Composition					Catalog Number	\$ Price
		Sealed	★	Normal	Sealed	Normal		
2	1	2	—	—	—	—	LA1DX20	65.00
		—	2	—	—	—	LA1DX02	65.00
		2	—	2	—	—	LA1DY20	77.00
4	1	2	—	—	2	—	LA1DZ40	82.00
		2	—	—	1	1	LA1DZ31	82.00

★ Grounding terminal points (2 terminals jumpered together; see diagram on page 8 of Catalog 8501CT0101).

▼ Auxiliary contact blocks with four contacts cannot be used on relays with low consumption coils.

Table 23.69: Coil Voltage Codes △

AC 50/60 Hz Coil (for additional voltage code options see page 7 of Catalog 8501CT0101).											
Volts	12	24	48	120	208	240	277	480	600		
Code	J7	B7	E7	G7	LE7	U7	W7	T7	X7		
DC Coil (coils have built in suppression as standard)											
Volts	12	24	36	48	60	72	110	125	220	250	440
Code	JD	BD	CD	ED	ND	SD	FD	GD	MD	UD	RD
DC Low Consumption Coil (coils have built in suppression as standard)											
Volts	5	12	24	48	72						
Code	AL	JL	BL	EL	SL						

△ Add the proper voltage code to the end of catalog number.

For replacement AC coils, see page 18-16. DC coils are not replaceable.

Approvals:



File E164353
CCN NKCR



File LR43364
Class 3211 03



TeSys® D IEC Style

Table 23.70: Time Delay Auxiliary Contact Blocks

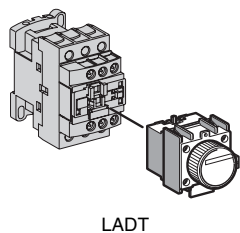

Number and Type of Contacts	Maximum Number per Device	Time Delay Type	Termination Type	Range	Catalog Number	\$ Price
	Front Mounting					
1 N.C. and 1 N.O.	1	On-Delay	Screw Clamp	0.1–3 s ▲	LADT0	131.00
				0.1–30 s	LADT2	131.00
				10–180 s	LADT4	131.00
				1–30 s ■	LADS2	131.00
		Off-Delay	Spring Terminal	0.1–3 s ▲	LADT03	131.00
				0.1–30 s	LADT23	131.00
				10–180 s	LADT43	131.00
				1–30 s ■	LADS23	131.00
Off-Delay	Screw Clamp	0.1–3 s ▲	LADR0	131.00		
		0.1–30 s	LADR2	131.00		
		10–180 s	LADR4	131.00		
		0.1–3 s ▲	LADR03	131.00		
(Lockout Cover, See page 7 of Catalog 8501CT0101.)			Spring Terminal	0.1–30 s	LADR23	131.00
				10–180 s	LADR43	131.00

- ▲ With extended scale from 0.1 to 0.6 s.
- With switching time of 40 ms ± 15 ms between opening of the N.C. contact and closing of the N.O. contact.

Table 23.71: Mechanical Latch Blocks

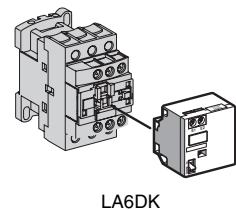

Unlatching Control	Maximum Number per Device	Catalog Number	\$ Price
	Front mounting		
Manual or electrical	1	LA6DK10 ▼★ LAD6K10 ▼	77.00 77.00

- ◆ Power should not be simultaneously applied or maintained to the mechanical latching block and the CAD relay. The duration of the control signal to the mechanical latching block and the CAD relay should be ≤ 100 ms.
- ★ Repair part for the preceding version (non-TeSys) of this product. Not for use on CAD devices.
- ▼ Complete the catalog number by adding coil voltage code from Table 23.73. (for example, LA6DK10B)

Table 23.72: Coil Suppressor Modules

These modules clip onto the right hand side of the control relay and the electrical connection is instantly made. Adding an input module is still possible.

RC Circuits (Resistor-Capacitor)

- Effective protection for circuits highly sensitive to “high frequency” interference.
- Voltage limited to 3 Uc maximum and oscillating frequency limited to 400 Hz maximum.
- Slight increase in drop-out time (1.2 to 2 times the normal time).

For Mounting On:	Operational Voltage	Catalog Number	\$ Price
CAD (Vac)	24 to 48 Vac	LAD4RCE	26.20
	110 to 240 Vac	LAD4RCU	26.20

Varistors (Peak Limiting)

- Protection provided by limiting the transient voltage value to 2 Uc maximum.
- Maximum reduction of transient voltage peaks.
- Slight increase in drop-out time (1.1 to 1.5 times the normal time).

CAD (Vac)	Operational Voltage	Catalog Number	\$ Price
CAD (Vac)	24 to 48 Vac	LAD4VE	26.20
	50 to 127 Vac	LAD4VG	26.20
	110 to 250 Vac	LAD4VU	26.20

Bidirectional Peak Limiting Diode

- Protection provided by limiting the transient voltage value to 2 Uc maximum.
- Maximum reduction of transient voltage peaks.

CAD (Vac)	Operational Voltage	Catalog Number	\$ Price
CAD (Vac)	24 Vac	LAD4TB	26.20
	72 Vac	LAD4TS	26.20

Table 23.73: Coil Voltage Codes

Voltage	24 Vac/Vdc	32/36 Vac/Vdc	42/48 Vac/Vdc	60/72 Vac/Vdc	100 Vac/Vdc	110/127 Vac/Vdc	220/240 Vac/Vdc	256/277 Vac/Vdc	380/415 Vac/Vdc
Voltage Code	B	C	E	EN	K	F	M	U	Q

CAD (Vac Coil)

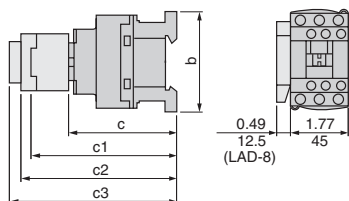

	in. (mm)	
CAD	32 50	323 503
b	3.03 (77)	3.90 (99)
c	Without cover or add-on blocks	3.31 (84)
	With cover, without add-on blocks	3.39 (86)

CAD (Vdc Coil) or (Low Consumption Vdc Coil)

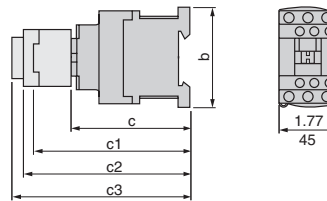

	in. (mm)	
CAD	32 50	323 503
b	3.03 (77)	3.90 (99)
c	Without cover or add-on blocks	3.66 (93)
	With cover, without add-on blocks	3.74 (95)

TeSys® D IEC Style Relays

Table 23.74: Cabling Accessory

Description		Catalog Number	\$ Price	
Mounting Adapter For adapting existing wiring to a new product	Without coil suppression	LAD4BB	23.00	
	With coil suppression	24 to 48 Vac	LAD4BBVE	23.00
		50 to 127 Vac	LAD4BBVG	23.00
		110 to 250 Vac	LAD4BBVU	23.00

Table 23.75: Electronic Serial Timer Modules ▲

• Mounted using adaptor LAD4BB, to be ordered separately, see listing above.

On-delay Type			
Operational Voltage	Time Delay	Catalog Number	\$ Price
24 to 250 Vac	0.1 to 2 s	LA4DT0U	82.00
	1.5 to 30 s	LA4DT2U	82.00
	25 to 500 s	LA4DT4U	82.00

▲ For 24 V operation, the relay must be fitted with a 21 V coil (code Z7).

Table 23.76: Auto-Man-Stop Control Modules

For local override operation tests with two-position "Auto-Man" switch and "O-I" switch

• Mounted using adaptor LAD4BB, to be ordered separately, see listing above.

Operational Voltage	Catalog Number	\$ Price
24 to 100 Vac	LA4DMK	35.00

Table 23.77: Accessories (ordered separately)

For Connection				
Description	For Mounting On:	Must be Ordered in Multiples of:	Catalog Number	\$ Price ea.
For Marking				
Sheet of 64 self-adhesive blank labels 8 x 33	CAD, LAD (4 contacts), LA6DK	10	LAD21	5.20
Sheet of 112 self-adhesive blank labels 8 x 12	LAD (2 contacts), LADT	10	LAD22	5.20
For Protection				
Lockout cover	LADT, LADR	1	LA9D901	5.50
Relay cover preventing access to the moving contact carrier	CAD	1	LAD9ET1	5.20

Table 23.78: Application Data

Type	CAD (Vac)	CAD (Vdc)	CAD (Vdc) Low Consumption
Rated Insulation Voltage (Ui)	Conforming to IEC 60947-1-1 Overvoltage category III and degree of pollution 3	690 V	690 V
	Conforming to UL, CSA	600 V	600 V
Rated Impulse Withstand Voltage (Uimp)	Conforming to IEC 60947-1-1	6 kV	6 kV
Separation of Electrical Circuits	To IEC 536 and VDE 0106	Reinforced insulation up to 400 V	
Conforming to Standards		IEC 60947-1-1, N-F C 63-140, VDE 0660, BS 4794. EN 60947-5-15	
Approvals		UL: File: E164353 CSA: File: LR43364 CE	CCN: NKCR Class: 3211 03
Protective Treatment	Conforming to IEC 68	"TH" (Tropical Finish). See page 23 of Catalog 8501CT0101 for details.	
Degree of Protection	Conforming to VDE 0106	Front face protected against direct finger contact IP 2X	Protection against direct finger contact

TeSys® K IEC Style Relays

Table 23.79: Control Relays

Control Circuit		Type of Termination	Contact Configuration		Catalog Number ▲	\$ Price		
			N.O.	N.C.				
Supply	Consumption							
AC	4.5 VA	Screw clamp	4	0	CA2KN40**	35.50		
			3	1	CA2KN31**	35.50		
			2	2	CA2KN22**	35.50		
		Spring Termination	4	0	CA2KN403**	35.50		
			3	1	CA2KN313**	35.50		
			2	2	CA2KN223**	35.50		
		Faston 1 x 6.35 or 2 x 2.8	4	0	CA2KN407**	35.50		
			3	1	CA2KN317**	35.50		
			2	2	CA2KN227**	35.50		
		Solder pins for printed circuit board	4	0	CA2KN405**	35.50		
			3	1	CA2KN315**	35.50		
			2	2	CA2KN225**	35.50		
		DC	3 W	Screw clamp	4	0	CA3KN40**	49.20
					3	1	CA3KN31**	49.20
					2	2	CA3KN22**	49.20
Spring Termination	4			0	CA3KN403**	49.20		
	3			1	CA3KN313**	49.20		
	2			2	CA3KN223**	49.20		
Faston 1 x 6.35 or 2 x 2.8	4			0	CA3KN407**	49.20		
	3			1	CA3KN317**	49.20		
	2			2	CA3KN227**	49.20		
Solder pins for printed circuit board	4			0	CA3KN405**	49.20		
	3			1	CA3KN315**	49.20		
	2			2	CA3KN225**	49.20		

▲ Complete catalog number by adding proper voltage code from Table 23.81 or Table 23.82 (for example, CA2KN40G7).

Table 23.80: Low Consumption Control Relays

Compatible with programmable controller outputs.

- LED indicator incorporated.
- Wide range coil (70 to 130% U_c), suppressor fitted as standard.
- Mounting on 35 mm DIN 3 track or 4 screw direct mounting.
- Screws in open "ready-to-tighten" position.

Control Circuit		Type of Termination	Contact Configuration		Catalog Number	\$ Price
			N.O.	N.C.		
Supply	Consumption					
DC	1.8 W	Screw clamp	4	0	CA4KN40***	64.00
			3	1	CA4KN31***	64.00
			2	2	CA4KN22***	64.00
		Spring Termination	4	0	CA4KN403***	64.00
			3	1	CA4KN313***	64.00
			2	2	CA4KN223***	64.00
		Faston 1 x 6.35 or 2 x 2.8	4	0	CA4KN407***	64.00
			3	1	CA4KN317***	64.00
			2	2	CA4KN227***	64.00
		Solder pins for printed circuit board	4	0	CA4KN405***	64.00
			3	1	CA4KN315***	64.00
			2	2	CA4KN225***	64.00

▲ Complete catalog number by adding proper voltage code from Table 23.83 (for example, CA4KN40BW3).

Table 23.81: Coil Voltage Codes for CA2K Control Relays (0.8–1.15 U_c) (0.85–1.1 U_c)

Vac 50/60 Hz	12	24	36	42	48	110	120	127	208	220/ 230	230	230/ 240	380/ 400	400	400/ 415	440	480	500	660/ 690
Voltage Code	J7	B7	C7	D7	E7	F7	G7	FC7	L7	M7	P7	U7	Q7	V7	N7	R7	T7	S7	Y7

Note: Up to and including 240 V, coil with integral suppression device available: add 2 to the code required. Example: J72. (Price Adder 9.50)

Table 23.82: Coil Voltage Codes for CA3K Control Relays (0.8–1.15 U_c)

Vdc	12	20	24	36	48	60	72	100	110	125	200	220	230	240	250
Voltage Code	JD	ZD	BD	CD	ED	ND	SD	KD	FD	GD	LD	MD	MPD	MUD	UD

Note: Coil with integral suppression device available: add 3 to the code required. Example: JD3. (Price Adder 9.50)

Table 23.83: Coil Voltage Codes for CA4K, Low Consumption Control Relays (Wide Range Coil: 0.7–1.3 U_c)

Vdc	12	24	48	72
Voltage Code	JW3	BW3	EW3	SW3

Approvals:



File 164353
CCN NKCR



File LR43364
Class 3211 03



CA2KN40**



CA2KN403**



CA4KN405***



CA3KN407**

TeSys® K IEC Style Relays

Table 23.84: Instantaneous Auxiliary Contact Blocks ♦♦

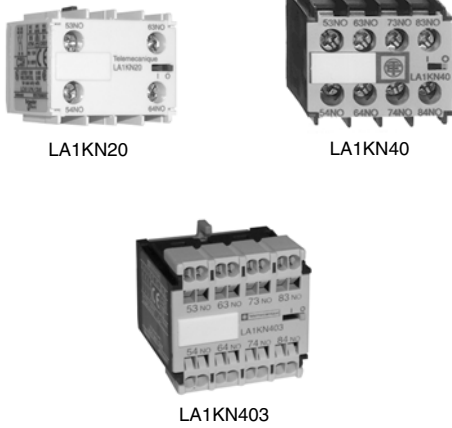

LA2KT electronic time delay contact blocks

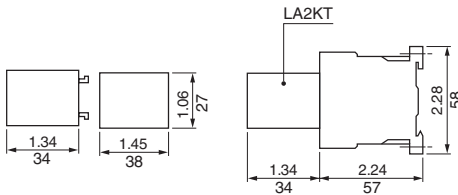

Approximate dimensions for CA2, CA3, CA4K control relays

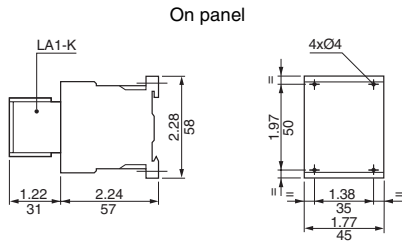

On printed circuit board

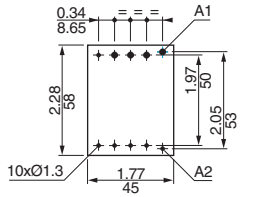

AM1DP200 or AM1DE200 mounting rail—35 mm DIN rail (see page 22-16 for additional DIN rail)

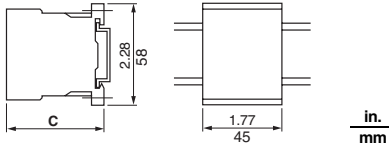

C		Product
in.	mm	
2.22	59	AM1DP200
2.60	66	AM1DE200

Type of Connection	Contact Configuration		Catalog Number	\$ Price
	N.O.	N.C.		
Clip-on Front Mounting, 1 Block Per Control Relay	2	0	LA1KN20	14.20
	0	2	LA1KN02	14.20
	1	1	LA1KN11	14.20
	4	0	LA1KN40▲	27.30
	3	1	LA1KN31▲	27.30
	2	2	LA1KN22▲	27.30
	1	3	LA1KN13▲	27.30
	0	4	LA1KN04▲	27.30
Screw Clamp	2	0	LA1KN203	14.20
	1	1	LA1KN113	14.20
	0	2	LA1KN023	14.20
	4	0	LA1KN403▲	27.30
	3	1	LA1KN313▲	27.30
	2	2	LA1KN223▲	27.30
	1	3	LA1KN133▲	27.30
	0	4	LA1KN043▲	27.30
Spring Termination	2	0	LA1KN207	14.20
	0	2	LA1KN027	14.20
	1	1	LA1KN117	14.20
	4	0	LA1KN407▲	27.30
	3	1	LA1KN317▲	27.30
	2	2	LA1KN227▲	27.30
	1	3	LA1KN137▲	27.30
	0	4	LA1KN047▲	27.30
Faston 1 x 6.35 or 2 x 2.8	2	0	LA1KN207	14.20
	0	2	LA1KN027	14.20
	1	1	LA1KN117	14.20
	4	0	LA1KN407▲	27.30
	3	1	LA1KN317▲	27.30
	2	2	LA1KN227▲	27.30
	1	3	LA1KN137▲	27.30
	0	4	LA1KN047▲	27.30

- ▲ Not to be used on CA4KN relays.
- Clip-on front mounting, 1 block per control relay.
- ♦ Auxiliary contact module not suitable for safety circuits.

Table 23.85: Electronic Time Delay Contact Blocks

Relay output, with common point changeover contact	240 Vac/Vdc, 2 A maximum
Control voltage	0.85–1.1 Uc
Maximum switching capacity	250 VA or 150 W
Operating temperature	–10 to +60°C (+14°F to 140°F)
Reset time	1.5 s during the time delay period, 0.5 s after the time delay.

Table 23.86: Clip-on front mounting, 1 block per control Relay

Voltage (V)	Type	Timing Range, s	Composition C.O.	Catalog No.	\$ Price
AC or DC / 24 to 48	On-delay	1 to 30	1	LA2KT2E	32.80
AC / 110 to 240				LA2KT2U	

Note: For other electronic timers see Type RE7 and 9050 Type JCK, pages 23-28 and 23-29.

Table 23.87: Accessories (supplied separately)

Description	Sold in lots of	Catalog No.	\$ Price ea.		
Marker holder□	Clips on front of relay	100	LA9D90	0.06	
Clip-on markers□	4 maximum per device	Strip of 10 identical numbers, 0 to 9	25	AB1R□	0.70
		Strip of 10 identical capital letters A to Z		AB1G□	
Suppressor modules with incorporated LED indicator	Clips onto front of relay with locating device. No tools required for connection.	For AC and DC voltages 12 to 24 V (varistor)	5	LA4KE1B★	9.80
		For AC and DC voltages 32 to 48 V (varistor)		LA4KE1E★	
		For AC and DC voltages 50 to 129 V (varistor)		LA4KE1FC★	
		For AC and DC voltages 130 to 250 V (varistor)		LA4KE1UG★	
		For DC voltages 12 to 24 V (diode + Zener diode)		LA4KC1B▼	
		For DC voltages 32 to 48 V (diode + Zener diode)		LA4KC1E▼	
	For AC voltages 220 to 250 V (RC)		LA4KA1UA		

- ★ Protection by the limitation of the transient voltage to 2 Uc maximum. Maximum reduction of the transient voltage peaks. Slight time delay on drop-out (1.1 to 1.5 times normal).
- ▼ No overvoltage or oscillation frequency. Polarized component. Slight time delay on drop-out (1.1 to 1.5 times normal).
- △ Protection by limitation of the transient voltage to 3 Uc max. and limitation of the oscillation frequency. Slight time delay on drop-out (1.2 times to twice normal).
- See "Clip-in Marker Strips" in Catalog 8501CT0101 for information on completing the catalog number.

Table 23.88: Environment

Conforming to Standards		IEC 947, NF C 63-140, VDE 0660, BS 5424, CE
Approvals		UL, CSA, DEMKO, NEMKO, SEMKO, FI
Protective treatment	Conforming to IEC 68 (DIN 50016)	"TC" (Climateproof)
Degree of protection	Conforming to VDE 0106	Protection against direct finger contact
Ambient air temperature	Storage	–58 to 176 °F (–50 to 80°C)
	Operation	–13 to 122 °F (–25 to 50°C)
Maximum operating altitude	Without derating	6562 ft (2000 m)

TeSys® SK IEC Style Relays

Table 23.89: IEC Style Industrial Control Relays

- Miniature size saves space.
- Mounts on 35 mm DIN 3 track
- Up to 4 poles.

Control Circuit Supply	Consumption	Type of Termination	Contact Configuration		Catalog Number	\$ Price
			N.O.	N.C.		
AC	4.2 VA	Screw clamp	1	1	CA2SK11**▲	43.70
			2	0	CA2SK20**▲	
DC	2.2 W		1	1	CA3SK11**▲	51.00
			2	0	CA3SK20**▲	

▲ Use the appropriate voltage code to complete the catalog number (for example: CA2SK11G7)



CA2SK11G7

Table 23.90: Contact Adder Decks (for CA2SK20 only)

Type of Termination	Contact Configuration		Catalog Number	\$ Price
	N.O.	N.C.		
Screw clamp	2	0	LA1SK20	16.90
	1	1	LA1SK11	
	0	2	LA1SK02	



LA1SK11

Transient Suppressor Module

Dampens the voltage spike that may occur when the relay coil is de-energized. The spike may adversely affect solid state equipment near the relay. The transient suppressor module snaps into a cavity located in the side of the relay. These modules can be used with CA2SK and CA3SK relays.

Table 23.91: Transient Suppressor Module

Control Circuit Voltage	Catalog Number	\$ Price
24–48 Vac 50/60 Hz, 24–48 Vdc	LA4SKEIE	21.80
110–250 Vac 50/60 Hz, 110–250 Vdc	LA4SKEIU	

Table 23.92: Coil Voltage Codes for Control Relays

Voltage	12	24	36	48	72	110	120	220	230	240	380	400	480
50/60 Hz	—	B7 ■	—	E7 ■	—	F7	G7 ■	M7 ■	P7	U7 ■	Q7	V7	T7 ■
DC	JD	BD	CD	ED	SD	—	—	—	—	—	—	—	—

■ Alternating relays CA2SKE available in these voltages only. No other voltages are available.

Alternating Relays, CA2SKE

Refer to Catalog 8501CT9701

These alternating relays are used to alternate the use of 2 motor circuits. When the coil is energized the first time, one contact closes and will open when the coil is de-energized. When the coil is energized again, the other contact will close and will open when the coil is de-energized. The contacts from these alternators are to be used in the control circuit of the starters that are controlling pump or compressor motors.

Approvals: UL File: E164353 CCN: NKCR; CSA File: LR43364 Class: 3211 03.

Table 23.93: Alternating Relays

Coil Voltage (Voltage-Hz)	Type	\$ Price
24–50/60	CA2SKE20**▲	120.00

▲ Use the appropriate voltage code to complete the catalog number (for example, CAZSK11G7). Only available with voltages indicated above.

Table 23.94: Contact Ratings for CA2SK, CA3SK, AND CA2SKE20 Relays

Volts	AC						DC		
	NEMA Rating	Inductive 35% PF				Continuous Amperes	Make, Break and Continuous Amperes	Volts	Continuous Amperes
		Make		Break					
120	A600	A	VA	A	VA	10	10	24	3
240		60	7200	6	720			60	2
480		30		3				110	0.8
600		15		1.5				240	0.2

Approximate Dimensions for CA2SKE Relay

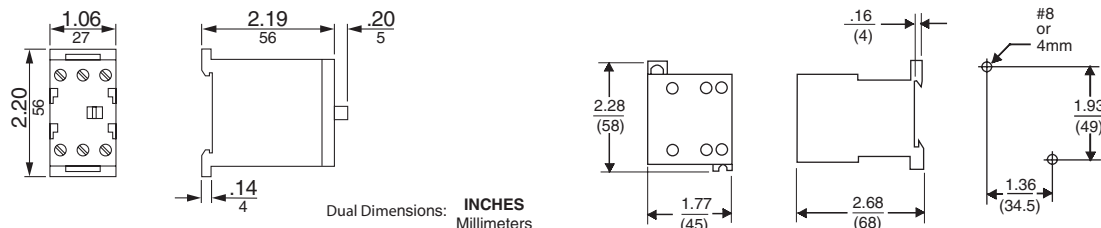

Approvals:



File E164353
CCN NKCR



File LR43364
Class 3211 03



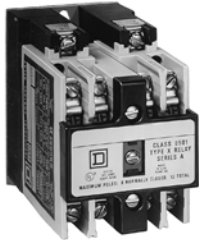

Type XMO40
Control Relay

AC Control Relays

- Straight-through wiring
- Plug-in contact cartridges for easy contact conversion and replacement
- Contact conversion without removing terminal screws or wires
- Self-lifting pressure wire connectors
- Replaceable coil

Table 23.95: AC Control Relays

Normally Open Convertible Instantaneous Contacts	Control Relay ▲	
	Type ♦	\$ Price
0	XO00	116.00
2	XO20	171.00
3	XO30	201.00
4	XO40	228.00
6	XO60	286.50
8	XO80	312.00
10	XO1000	399.00
12	XO1200	458.00

▲ A maximum of 8 N.C. contacts is allowed on 9–12 pole relays.

AC Master Relays

- 20 ampere contact rating due to use of master contact cartridges. ★
- Provisions for standard cartridges to be used in contact cavities not occupied by master cartridges in 2-8 pole AC relay.

Table 23.96: AC Master Relays

Number of N.O. 20 Ampere Convertible Contacts	Open Type ■	
	Type ♦	\$ Price
2	XMO20	257.00
4	XMO40	399.00
6	XMO60	543.00

■ Attachments not permitted on this relay.



Type XMO40
Master Relay

AC Timing Relays

- Easily convertible On Delay or Off Delay
- Two adjustable timing ranges
- Repeat accuracy well above ±10%
- Convertible 1 N.O. and 1 N.C. timed contacts
- Large knob for easy adjustment of time delay
- Off Delay mode times out even after loss of power.

Table 23.97: AC Timing Relays

Timing Mode	N.O. Convertible Instantaneous Contacts	Timed Convertible Contacts		Timing Relay		\$ Price
		N.O.	N.C.	0.2–60 s	5–180 s	
				Type ♦	Type ♦	
On Delay	0	1	1	XO00XTE1	XO00XTE2	513.00
	2	1	1	XO20XTE1	XO20XTE2	570.00
	4	1	1	XO40XTE1	XO40XTE2	629.00
Off Delay	0	1	1	XO00XTD1	XO00XTD2	513.00
	2	1	1	XO20XTD1	XO20XTD2	570.00
	4	1	1	XO40XTD1	XO40XTD2	629.00

AC Latching Relays

- Mechanical latch holds all contacts switched even after removal of power from replaceable latching coil.
- Provides sequence memory in the event of power loss. Ideal for press control, process control and punch presses.
- Replaceable unlatch coil to switch contacts back to original state.

Table 23.98: AC Latching Relays

N.O. Convertible Instantaneous Contacts	Latching Relay	
	Type ♦	\$ Price
2	XO20XL	372.00
3	XO30XL	399.00
4	XO40XL	428.00
6	XO60XL	485.00
8	XO80XL	543.00

♦ Voltage Code must be specified to order these products. Refer to Table 23.101 and insert the code as shown in Table 23.104: How to Order.

Approvals:



File E78403
CCN NKCR



File 060905
Class 3211 03



IEC 60947-1

Table 23.99: AC Contact Ratings
(for DC ratings, see page 23-22)

Type of Cartridge	V	Inductive 35% Power Factor				Continuous Amperes	Resistive 75% Power Factor	
		NEMA Rating	Make		Break			
			A	VA	A			VA
Standard or Overlapping	120 240 480 600	A600	60 30 15 12	7200	6 3 1.5 1.2	720	10	
Master★	—	A600	Same as standard cartridge above except substitute 20 A for the continuous ampere rating				10	
Logic Reed	—	—	150 Vac, 150 mA, 8 W Maximum				—	

★ Maximum of six 8501 Type XC4 Master Cartridges may be used on only 7 and 8 pole AC Devices

Table 23.100: Average Operating Time (ms)

Device	Pick-Up	Drop-Out
AC Relay	15	16
AC Latching Relay	15	13

Table 23.101: Voltage Codes

AC Voltages - Hz	Code
12–60	V11
24–60	V01
24–50	V12
48–60	V18
48–50	V16
120–60/110–50	V02
208–60	V08
240–60/220–50	V03
277–60	V04
480–60/440–50	V06
600–60/550–50	V07

AC Control Relays and AC Master Relays

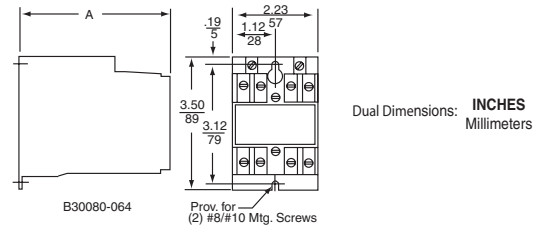

Table 23.102: Dimensions and Weight

No. of Poles	Dim. A		Shipping Weight, lb
	in.	mm	
0–4	3.95	100	2.0
6–8	5.16	131	2.3
10–12	6.36	162	2.7

AC Latching Relay Dimensions

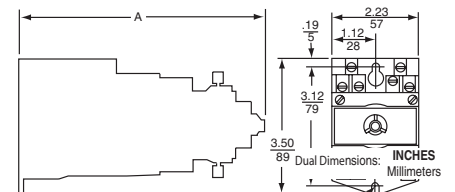

Table 23.103: Dimensions and Weight

No. of Poles	Dim. A		Shipping Weight, lb
	in.	mm	
2–4	6.54	166	2.8
6–8	7.74	197	3.1

For replacement coils, see page 23-23.

Table 23.104: How to Order

To Order Specify:	Catalog Number		
• Class Number	Class	Type	Voltage Code
• Type Number			
• Voltage Code	8501	XO40	V02

Industrial Relays Square D® NEMA Style

DC Control Relays



Type XDO40
Control Relay

- Replaceable, highly reliable pure DC power plant: no economizing resistors, overlapping contacts or dual-wound coil.
- Utilizes the same Type XB adder decks and attachments as the AC version.
- Offers all the features of the AC relay.
- Available in up to 8 poles.
- All contact poles are usable since no overlapping contacts are needed.

Table 23.105: DC Control Relays

Normally Open Convertible Instantaneous Contacts	Control Relay		\$ Price
	Type		
0	XDO00 ▼		257.00
2	XDO20 ▼		314.00
4	XDO40 ▼		372.00
6	XDO60 ▼		427.00
8	XDO80 ▼		485.00

DC Control Relay Utility Auxiliary Relay

Table 23.106: Dimensions

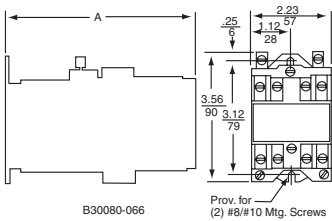

No. of Poles	Dim. A		Shipping Weight lb.
	in.	mm	
0-4	5.17	131	3.1
6-8	6.37	162	3.4
10-12	7.60	193	3.8

DC Timing Relays



Type XDO40XTE2
Timing Relay

- Easily convertible On Delay or Off Delay.
- Two adjustable timing ranges.
- Repeat accuracy well above $\pm 10\%$.
- Convertible 1 N.O. and 1 N.C. timed contacts.
- Large knob for easy adjustment of time delay.
- Off Delay mode times out even after loss of power.

Table 23.107: DC Timing Relays

Timing Mode	Normally Open Convertible Instantaneous Contacts	Timed Convertible Contacts		Timing Relay		\$ Price
		N.O.	N.C.	0.2-60 s	5-180 s	
				Type	Type	
On Delay	0	1	1	XDO00XTE1 ▼	XDO00XTE2 ▼	656.00
	2	1	1	XDO20XTE1 ▼	XDO20XTE2 ▼	714.00
	4	1	1	XDO40XTE1 ▼	XDO40XTE2 ▼	769.00
Off Delay	0	1	1	XDO00XTD1 ▼	XDO00XTD2 ▼	656.00
	2	1	1	XDO20XTD1 ▼	XDO20XTD2 ▼	714.00
	4	1	1	XDO40XTD1 ▼	XDO40XTD2 ▼	769.00

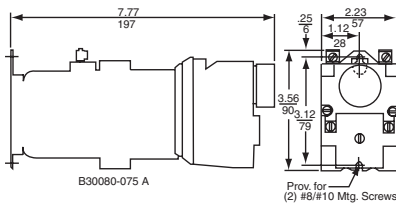

Table 23.108: DC Contact Ratings (for AC ratings, see page 23-21)

Type of Cartridge	DC Ratings					
	Volts	NEMA Rating	Inductive		Resistive	
			Make and Break Amperes 138 VA Max.	Continuous Amperes	Make and Break Amperes	Continuous Amperes
Standard	125 250	P600	1.1 0.55	5 5	4 0.8	5 5
Overlapping	125	P150	1.1	5	4	5
Logic Reed	—	—	30 Vdc, 60 ma			

Note: Do not use any 8501 Type XC4 Master Cartridges on any DC-operated device.

Type X® Relays



Class 8501 / Refer to Catalog 8501CT9601

by Schneider Electric
www.schneider-electric.us

DC Latching Relays



Type XDO40XDL
Latching Relay

- Mechanical latch holds all contacts switched even after removal of power from replaceable latching coil.
- Provides sequence memory in the event of power loss.
- Ideal for sequencing applications such as press control, process control and punch presses.
- Replaceable unlatch coil to switch contacts back to original state.

Table 23.109: DC Latching Relays

Normally Open Convertible Instantaneous Contacts	Latching Relay	
	Type	\$ Price
2	XDO20XDL ▼	567.00
4	XDO40XDL ▼	634.50
6	XDO60XDL ▼	691.50
8	XDO80XDL ▼	747.00

Note: Unlatch coil is rated for intermittent duty and should be connected through a N.O. contact of the relay if the input signal is maintained. Order one more N.O. contact than the application requires to use as a coil clearing contact.

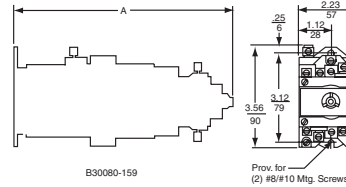

Table 23.110: Dimensions

No. of Poles	Dim. A		Shipping Weight, lb.
	in.	mm	
2-4	7.76	197	3.9
6-8	8.98	228	4.2

DC Utility Relays



Type XUDO40
Utility Relay

Ideal for utility plant applications where reliable performance and a pure DC power plant is required. In addition to the Type XDO relay features, the Type XUDO provides:

- Up to 12 poles N.O. or N.C.
- Nominal 125 Vdc coil, capable of handling 140 Vdc continuously and picking up at 105 Vdc after having been operated at 140 Vdc continuously. Other voltages with comparable operating characteristics are available.
- Enclosed device capable of operating in 145°F ambient.

Table 23.111: DC Utility Relays

Number of Convertible Contacts	Open Type		
	N.O.	N.C.	Type
4	0	0	XUDO40 ▼
0	4	0	XUDO04 ▼
8	0	0	XUDO80 ▼
0	8	0	XUDO08 ▼
12	0	0	XUDO1200 ▼
0	12	0	XUDO0012 ▼
			747.00

Table 23.112: Average Operating Times (in ms)

Device	Pick-Up	Drop-Out
DC Relay	37	21
DC Latching Relay	37	45

Table 23.113: Voltage Codes—8501 XUDO and XDO Relays

DC Voltages for 8501 XUDO Relays ONLY	Code	DC Voltages for 8501 XDO Relays	Code
6	V50	6	V50
12	V51	12	V51
24	V53	24	V53
48	V56	32	V54
125	V63	48	V56
250	V67	72	V58
		90	V59
		115/125	V62
		230/250	V66









▼ Voltage code must be specified to order these products. Refer to Table 23.113 and insert the appropriate code as shown in Table 23.114: How to Order.

Table 23.114: How to Order

To Order Specify:	Catalog Number		
• Class Number	Class	Type	Voltage Code
• Type Number	8501	XDO40	V53
• Voltage Code			

For Replacement coils, see page 23-23
For UL and CSA approvals, see page 23-21

Table 23.115: Type X® Relays

	Description	Type	\$ Price
	Mechanical Latch Attachment —Mounts on any 2 through 8-pole relay (except XMO master relay). The Type XL and XDL latch attachments are identical in size and mounting provisions. The Type XLAC latch attachment has a continuous-duty-rated coil which is replaceable. The Type XDLDC latch attachment has an intermittent-rated coil (replaceable) and should be connected through a N.O. contact of the basic relay if the input signal is maintained to the unlatch coil. AC Latch Attachment DC Latch Attachment	XL▲ XDL▲	201.00 264.00
	Pneumatic Timer Attachment —Mounts only on any 0 through 4-pole AC or DC relays (except XMO master relay). It provides 1 N.O. and 1 N.C. convertible timed contacts, which are the same Type XC1 cartridges used on the basic relay. Two timing ranges are available, and conversion from On Delay to Off Delay or vice versa is easy. Off Delay 0.2–60 seconds 5–180 seconds On Delay 0.2–60 seconds 5–180 seconds	XTD1 XTD2 XTE1 XTE2	399.00 399.00 399.00 399.00
	Timer Lockout Cover —Fits over the time delay adjustment knob of any Type XT timing attachment. The Lockout Cover is designed to protect the time setting against accidental adjustment. It mounts directly to the timing attachment with two included screws.	XJ1	10.70
	Adder Decks —Adder decks are used to expand the number of poles on a relay. The basic 4-pole relay can be easily converted to an 8-pole or 12-pole relay by installing one or two adder decks. The Class 8501 Type XB20 comes with 2 convertible contact cartridges and will accept 2 additional convertible contact cartridges. The Class 8501 Type XB40 comes with 4 convertible contact cartridges. The same Type XB adder deck is used for both the middle and upper decks of the AC or DC relay. With 2 N.O. contact cartridges With 4 N.O. contact cartridges	XB20 XB40	57.00 116.00
	Logic Reed Adder Deck —Used for switching low energy circuits. The Logic Reed Adder Deck is supplied with either one or two logic reed cartridges fixed into the center positions of an adder deck. Contact cartridges are neither convertible nor replaceable. Standard cartridges can be inserted in unused cavities of the Logic Reed Adder Deck. One or two Logic Reed Adder Decks may be added to the basic 4-pole relay. See Contact Rating Data on pages 23-40 and 23-2 for electrical ratings.	Number of N.O. Logic Reed Contact Cartridges 2 1 1 0 0	Number of N.C. Logic Reed Contact Cartridges 0 1 0 1 2
	Contact Cartridges —The Type X relay offers 4 Types of contact cartridges. All are color-coded for visual identification of each Type. Standard Cartridge —The standard cartridge, used for most applications, has a black case. Overlapping Cartridge —Same NEMA Type A600 AC rating as standard cartridge and a NEMA Type P150 DC rating. When it is used in the N.O. mode it will close early and when used in the N.C. mode it will open late. If two or more are used together, the N.O. contacts will close before the N.C. contacts open as the relay picks up. Overlap also occurs during dropout. Overlapping cartridge has a red case. May be ordered factory installed: • Substitute 1 N.O. and 1 N.C. overlapping cartridges for 2 standard cartridges. • Substitute 2 N.O. and 2 N.C. overlapping cartridges for 4 standard cartridges. • Substitute 3 N.O. and 3 N.C. overlapping cartridges for 6 standard cartridges. • Substitute 4 N.O. and 4 N.C. overlapping cartridges for 8 standard cartridges. Master Cartridge —Features the same contact ratings as the Type XC1 standard cartridge except it has a 20 ampere continuous current rating instead of 10 amperes. It can be used in circuits where a master relay is required. Master cartridge has a blue case. Maximum of 6 master cartridges may be used on any 7 and 8-pole AC relays. Do not use any master cartridges on 9-12-pole AC or any DC-operated devices. Note: If master cartridges are added to a standard relay, attachments (latch mechanism, timers, etc.) cannot be used. Logic Reed Cartridge —See logic reed adder deck above.	XC1 XC2 Form Y1591 Y1592 Y1593 Y1594 XC4	28.70 28.70 Add 28.70 Add 28.70 Add 28.70 Add 28.70 71.40
	Mounting Track —The mounting track has pre-punched mounting holes to simplify mounting the track on the control panel. The relay mounting screws are factory installed on the track so that the relays can be hung prior to tightening the screws. 9 in. long for 4 relays 18 in. long for 8 relays 27 in. long for 12 relays 36 in. long for 16 relays	XM4 XM8 XM12 XM16	23.48 35.40 43.20 51.00
	Manual Test Tool —Provides a means of manually switching the contacts of a basic relay or timing relay and holding all contacts in their switched state until the tool is removed. This simplifies the checking of control circuits without power on the coil or contacts.	XA1	7.20
	Transient Suppressor —Consists of an R-C circuit designed to suppress coil generated transients to approximately 200 percent of peak voltage. It is particularly useful when switching the Type X relay near solid state equipment. It is designed for use on coils up to 120 Vac.	XS1	57.00
	NEMA 1 Enclosure —Formed from sheet steel to provide strength and rigidity. Two conduit knockouts are located in both the top and bottom of the enclosure. The enclosure is furnished with self tapping screws for mounting the relay inside the enclosure. Accommodates a single 4 or 8-pole AC or DC relay, 12-pole AC relay, 4-pole AC latching relay, and 4-pole AC timing relay. Note: The 4-pole DC latching relay, 4-pole DC timing relay, 8-pole AC and DC latching relays and 12-pole utility auxiliary relay will not fit.	Class 9991 Type UE7	99.00

▲ See Mechanical Latch Attachment Voltage Codes table below:

Table 23.116: Mechanical Latch Attachment Voltage Codes

AC Voltage	Code	DC Voltage	Code
24–60	V01	6	V50
24–50	V12	12	V51
120–60/110–50	V02	18	V99
208–60	V08	24	V53
240–60/220–50	V03	48	V56
277–60	V04	72	V58
480–60/440–50	V06	90	V59
600–60/550–50	V07	115/125	V62
		230/250	V66

Table 23.117: How to Order

To Order Specify:	Catalog Number	
• Class Number	Class	Type
• Type Number	8501	XTE1
• Voltage Code for mechanical latch attachment		
• Form for factory installed overlapping contacts		

Table 23.118: Relay Coil Selection and Pricing

Device Type	Equipment To Be Serviced		Coil Prefix, or Class and Type	Hz	SUFFIX (The complete coil number consists of prefix or the Class and Type, followed by suffix.)													Coil Burden Watts	\$ Price
	Class	Type			6 V	12 V	18 V	24 V	32 V	48 V	64 V	72 V	90 V	110 V	115/125 V	220 V	230/250 V		
DC	8501	XD	9998 XD	—	19	28	34	37	40	46	49	52	55	—	58	—	67	18	183.00
		XDL	9998 XDL	—	19	28	34B	37B	40B	46B	49B	52B	55B	—	58B	—	67B	50	234.00
		XUD	9998 XUD	—	19	28	—	37	—	46	—	—	—	—	58★	—	67♦	16	183.00
Device Type	Class	Type	Coil Prefix or Class and Type	—	24 V	110-115 V	120 V	208 V	220 V	240 V	277 V	380 V	440 V	480 V	550 V	600 V	In-rush	Sealed	
AC	8501	XO, XMO	9998 X	60	23	—	44	51	52	53	55	—	—	62	—	65	148	23	74.70
				50	24	44	—	52	53	—	—	—	62	—	65	—	143	25	

■ To order an unlatch coil add the letter "L" to the type number and the letter "B" to the suffix number. Example: for a 120 V 60 Hz unlatch coil order a Class 9998 Type XL44B.
♦ Not dual rated—250 Vdc only
★ 125 Vdc only

Zelio® IEC Style—17.9 mm wide

Table 23.119: RE11 Modular Timers—17.9 mm wide (Multi-range timers offering 7 selectable ranges)



RE11RLMU

Functions	Supply Voltages	Rated Current	Catalog Number	\$ Price
Output 1 C/O contact				
On delay	24 Vdc, 24–240 Vac	8A	RE11RAMU	51.00
Interval	24 Vdc, 24–240 Vac	8A	RE11RHMU	51.00
Asymmetrical repeat cycle	24 Vdc, 24–240 Vac	8A	RE11RLMU	63.00
Asymmetrical repeat cycle	12 Vac/Vdc	8A	RE11RLJU	89.00
One shot	24 Vdc, 24–240 Vac	8A	RE11RBMU	62.00
Off delay with control start	24 Vdc, 24–240 Vac	8A	RE11RCMU	62.00
Multi-function ▲	24 Vdc, 24–240 Vac	8A	RE11RMU	74.00
Multi-function ▲	12–240 Vac/Vdc	8A	RE11RMMW	89.00
Multi-function ▲	12–240 Vac/Vdc	8A	RE11RMMWS	89.00
Multi-function ▲	12 Vac/Vdc	8A	RE11RMJU	89.00
Multi-function ■	24 Vdc, 24–240 Vac	8A	RE11RMEMU	89.00
Multi-function ▲	24 Vdc, 24–240 Vac	8A	RE11RMXMU	89.00

▲ Timing ranges: 0.1–1 s, 1–10 s, 0.1–10 min, 1–10 min, 0.1–1 hr, 1–10 hr, 10–100 hr

■ Timing ranges: 0.1–1 s, 1–10 s, 0.1–10 min, 1–10 min, 0.1–1 hr, 1–10 hr

Conforming to standards		IEC 61812-1, EN 50081-1/2, EN 50082-1/2, LV directives (73/23/EEC + 93/68/EEC (CE marking) + EMC directive (89/336/EEC + IEC 60669-2-3)		
		cULus	File: E173076 CNN: NRNT	
			File: E173076 CNN: NRNT7	
Approvals		CSA	File: 217698 Class 3211 07	
		CE		
		GL except RE11 RMX MU and RE11 RME MU		
Ambient air temperature around the device	Storage	°F (°C)	–22 to +140 (–30 to +60)	
	Operation	°F (°C)	–4 to +140 (–20 to +60)	



RE11LHBM

Table 23.120: RE11 Modular Timers—17.9 mm wide (Multi-function, dual function or single function)

Functions	Supply Voltages	Rated Current	Catalog Number	\$ Price
Solid state output				
On delay	24–240 Vac/Vdc	0.7A	RE11LAMW	54.00
Interval	24–240 Vac	0.7A	RE11LHBM	51.00
Off delay with control contact	24–240 Vac	0.7A	RE11LCBM	62.00
Asymmetrical repeat cycle	24–240 Vac	0.7A	RE11LLBM	89.00
Multi-function	24–240 Vac	0.7A	RE11LMBM	74.00

Timing ranges: 0.1–1 s, 1–10 s, 0.1–10 min, 1–10 min, 0.1–1 hr, 1–10 hr, 10–100 hr

Conforming to standards		IEC 61812-1, EN 50081-1/2, EN 50082-1/2, LV directives (73/23/EEC + 93/68/EEC (CE marking) + EMC directive (89/336/EEC + IEC 60669-2-3)		
		cULus	File: E173076 CNN: NRNT	
			File: E173076 CNN: NRNT7	
Approvals		CSA	File: 217698 Class: 3211 07	
		CE		
Ambient air temperature around the device	Storage	°F (°C)	–22 to 140 (–30 to +60)	
	Operation	°F (°C)	–4 to 140 (–20 to +60)	

Table 23.121: RE48 Panel Mount Timers (For required socket, refer to the catalog section)



RE48A TM12MW

Functions	Supply Voltages	Rated Current	Catalog Number	\$ Price
Single function: on delay, two relay outputs	24–240 Vac/Vdc	2 x 5 A	RE48ATM12MW	87.00
Repeat cycle: two relay outputs	24–240 Vac/Vdc	2 x 5 A	RE48ACV12MW	104.00
Multi-function: on delay, one shot, off delay, repeat cycle	24–240 Vac/Vdc	2 x 5 A	RE48AML12MW	102.00
Multi-function: on delay and interval, two relay outputs, of which one selectable and instantaneous	24–240 Vac/Vdc	2 x 5 A	RE48AMH13MW	102.00

Conforming to standards		IEC 61812-1, EN 50081-1/2, EN 50082-1/2, LV directives (73/23/EEC + 93/68/EEC (CE marking) + ENC directive (89/336/EEC + IEC 60669-2-3)		
		cURus	File: E173076 CNN: NRNT2	
			File: E173076 CNN: NRNT8	
Approvals		CSA	File: 217698 Class: 3211 07	
		CE, C-Tick, GL		
		RoHS compliant as of date code 0625		
Ambient air temperature around the device	Storage	°F (°C)	–40 to 158 (–40 to +70)	
	Operation	°F (°C)	–4 to 122 (–20 to +50)	

Table 23.122: REXL Miniature Plug-in Timers (For required socket, refer to the catalog section)



Function	Supply Voltages	4 pole			2 pole		
		Rated Current	Catalog Number	\$ Price	Rated Current	Catalog Number	\$ Price
Single function (On-Delay)	12 Vdc	3A	REXL4TMJD	66.00	5A	REXL2TMJD	63.00
	24 Vdc ♦	3A	REXL4TMBD	66.00	5A	REXL2TMBD	63.00
	24 Vac 50/60 Hz ♦	3A	REXL4TMB7	66.00	5A	REXL2TMB7	63.00
	120 Vac 50/60 Hz	3A	REXL4TMF7	66.00	5A	REXL2TMF7	63.00
	230 Vac 50/60 Hz	3A	REXL4TMP7	66.00	5A	REXL2TMP7	63.00
Timing Ranges		0.1–1 s, 1–10 s, 0.1–1 min, 1–10 min, 0.1–1 hr, 1–10 hr, 10–100 hr					

For 48 Vac supply, additional resistor 390 ohm 4 W / 24 V

♦ For 48 Vac supply, additional resistor 560 ohm 2 W / 24 V

Approvals:



File CCN E173076 NRNT2
File CCN E173076 NRNT8



File Class 217698 321107



IEC 61812-1

RoHS Compliant as of date code 0625

Zelio® IEC Style—22.5 mm

These timers offer multi range timing from 0.05 to 300 hours, in 10 timing ranges.

Table 23.123: RE7M 6 Function and 8 Function Timers



RE7MY

6 Function Timer				
Function	Supply Voltages	Relay Output	Catalog Number	\$ Price
On-Delay Timer Off-Delay Timer Interval Timer • start on energization • start on opening of remote control contact Repeat Cycle Timer with start during the OFF period. Repeat Cycle Timer with start during the ON period External control possible for: • start of time delay • partial stop of time delay • adjustment of time delay	24 Vdc or Vac 42–48 Vdc or Vac 110–240 Vac	1 C/O, SPDT 	RE7ML11BU	279.00
Same as 6 Function Timer ▲ plus Timer for star-delta starting • with double On-Delay timing • with changeover contact to star connection	24 Vdc or Vac 110–240 Vac	2 C/O, DPDT 	RE7MY13BU	311.00
	24–240 Vdc or Vac	2 C/O, DPDT 	RE7MY13MW	342.00

▲ Except control of partial stop of time delay for RE7MY13BU.

Table 23.124: RE7T On-Delay Timers



RE7T

Functions	Supply Voltages	Relay Output	Catalog Number	\$ Price
On-Delay Timer	24 Vdc or Vac 110–240 Vac	1 C/O, SPDT 	RE7TL11BU	171.00
On-Delay Timer External control possible for: • start of time delay • partial stop of time delay • adjustment of time delay ■	24 Vdc or Vac 42–48 Vdc or Vac 110–240 Vac	1 C/O, SPDT 	RE7TM11BU	218.00
On-Delay Timer Remote control possible for: adjustment of time delay ■	24 Vdc or Vac 42–48 Vdc or Vac 110–240 Vac	2 C/O ♦, DPDT 	RE7TP13BU	343.00

Table 23.125: RE7M Symmetrical and Asymmetrical Timers



RE7M

Functions	Supply Voltages	Relay Output	Catalog Number	\$ Price
Symmetrical Timers: On and Off delay times are equal.				
On-Delay and Off-Delay Timer External control possible for: • partial stop of time delay • adjustment of time delay ■ Start control via external contact only	24 Vdc or Vac 42–48 Vdc or Vac 110–240 Vac	1 C/O, SPDT 	RE7MA11BU	240.00
On-Delay and Off-Delay Timer Start control via external contact only	24 Vdc or Vac 42–48 Vdc or Vac 110–240 Vac	2 C/O ♦, DPDT 	RE7MA13BU	257.00
Asymmetrical Timers: On and Off delay times are adjusted separately.				
On-Delay and Off-Delay Timer External control possible for: • partial stop of time delay • adjustment of time delay ■ Start control via external contact only	24 Vdc or Vac 42–48 Vdc or Vac 110–240 Vac	1 C/O, SPDT 	RE7MV11BU	264.00

■ By external potentiometer, to be ordered separately (see page 3 of Catalog 9050CT0001 for specifications). If external potentiometer is used, the internal potentiometer is automatically disconnected.
♦ A switch on the front face of the timer allows the second contact to be used in instantaneous mode.

Table 23.126: Output Circuit Specifications for RE7

Current Limit, Ith		8 A		
Rated Operational Limits at 70°C		24 V	115 V	250 V
Conforming to IEC60947-5-1/1991 and VDE 060	AC-15 N.C. contact	3 A	3 A	3 A
	AC-15 N.O. contact	5 A	5 A	5 A
	DC-13 N.O. contact	2 A	0.2 A	0.1 A
UL and CSA Current	Resistive Rating	5 A		
NEMA / UL B300	Inductive Rating	3600 VA Make, 360 VA Break, 5 A Carry		

Table 23.127: Output Circuit Specifications for RE8

Maximum Switching Voltage		250 Vac/Vdc		
Current Limit Ith		8 A		
Rated Operational Limits at 150°F (70°C)		24 V	115 V	250 V
Conforming to IEC 60947-5-1/1991 and VDE 0660	AC-15	3 A	3 A	3 A
	DC-13	2 A	0.2 A	0.1 A
UL and CSA Current Ratings (Resistive)		5 A		
NEMA / UL B300 Ratings (Inductive)		3600 VA Make, 360 VA Break, 5 A Carry		

RE7, RE8, and RE9 Timers comply to the following:

Conforming to Standards	IEC 61812-1, EN 61812-1		
Product Approvals	US LISTED File E164353 NKCR	File 089150 Class 3211-07	IEC 61812-1
CE Marking	RE7, RE8, and RE9 Timers conform to European regulations relating to CE Marking		
Ambient Air Temperature	Storage	-40°F to +185°F (-40°C to +85°C)	
	Operation	-4°F to +140°F (-20°C to +60°C)	

Zelio® IEC Style—22.5 mm



RE7R



RE7P



RE7C

Table 23.128: RE7R Timers Off-Delay Timers

Functions	Supply Voltages	Relay Output	Catalog Number	\$ Price
On De-energization, Adjustable from 0.05 s to 10 min, in 7 Ranges				
Off-Delay Timer (Times without power)	24–240 Vdc or Vac	1 C/O SPDT	RE7RB11MW▲	233.00
Off-Delay Timer Remote control possible for: • adjustment of time delay ■	24–240 Vdc or Vac	2 C/O DPDT	RE7RB13MW▲	264.00
On Opening of External Control Contact, Adjustable from 0.05 s to 300 h, in 10 Ranges				
Off-Delay Timer External control possible for: • partial stop of time delay • adjustment of time delay ■	24 Vdc or Vac 42–48 Vdc or Vac 110–240 Vac	1 C/O SPDT	RE7RA11BU	203.00
On opening of Low Level External Control Contact, Adjustable from 0.05 s to 300 h, in 10 Ranges				
Off-Delay Timer External control possible for: • partial stop of time delay • adjustment of time delay ■	24 Vdc or Vac 42–48 Vdc or Vac 110–240 Vac	1 C/O SPDT	RE7RM11BU	218.00
Off-Delay Timer	24 Vdc or Vac 42–48 Vdc or Vac 110–240 Vac	2 C/O♦, DPDT	RE7RL13BU	233.00

▲ If the device has been stored de-energized for more than a month, it must be energized for about 15 seconds to activate it. Subsequently, a time of > 1 s is enough to activate the time delay.

Note: If this time is not complied with, the relay will remain energized indefinitely.

Table 23.129: RE7P Interval Timers

Functions	Supply Voltages	Relay Output	Catalog Number	\$ Price
Start on Energization				
Interval Timer	24 Vdc or Vac 110–240 Vac	1 C/O SPDT	RE7PE11BU	186.00
Interval Timer External control possible for: • adjustment of time delay ■	24 Vdc or Vac 42–48 Vdc or Vac 110–240 Vac	2 C/O♦ DPDT	RE7PP13BU	233.00
Start on Opening of External Control Contact				
Interval Timer External control possible for: • partial stop of time delay • adjustment of time delay ■	24 Vdc or Vac 42–48 Vdc or Vac 110–240 Vac	1 C/O SPDT	RE7PM11BU	186.00
Interval Timer	24 Vdc or Vac 42–48 Vdc or Vac 110–240 Vac	2 C/O♦ DPDT	RE7PD13BU	233.00

Table 23.130: RE7C Timers Symmetrical and Asymmetrical Relays

Functions	Supply Voltages	Relay Output	Catalog Number	\$ Price
Symmetrical Relays with Start during Off Period				
Repeat Cycle Timer	24 Vdc or Vac 110–240 Vac	1 C/O SPDT	RE7CL11BU	203.00
Repeat Cycle Timer External control possible for: • adjustment of time delay ■	24 Vdc or Vac 42–48 Vdc or Vac 110–240 Vac	2 C/O♦ DPDT	RE7CP13BU	249.00
Asymmetrical, with Separate Adjustment of On-Delay and Off-Delay				
Repeat Cycle Timer External control possible for: • start period • adjustment of time delays ■ • partial stop	24 Vdc or Vac 42–48 Vdc or Vac 110–240 Vac	1 C/O SPDT	RE7CV11BU	264.00

■ By external potentiometer, to be ordered separately (see page 3 of Catalog 9050CT0001 for specifications). If external potentiometer is used, the internal potentiometer is automatically disconnected.

♦ A switch on the front face of the timer allows the second contact to be used in instantaneous mode.

For conformance to standards, see page 23-30

RoHS Compliant as of date code 0626

Zelio® IEC Style—22.5 mm

Table 23.131: On-Delay (timing starts on energization), TDE



Relay Output	Supply Voltages	Timing Range ▲	Catalog Number	Standard Pack Quantity ■	\$ Price
 1 C/O SPDT	24 Vdc or Vac 110–240 Vac	0.1–3 s	RE8TA61BUTQ	10	93.00
		0.1–10 s	RE8TA11BUTQ ★	10	93.00
		0.3–30 s	RE8TA31BUTQ ★	10	93.00
		3–300 s	RE8TA21BUTQ ★	10	93.00
		20 s–30 min	RE8TA41BUTQ	10	93.00

Table 23.132: Off-Delay (timing starts on de-energization), TDD

Control Contact					
 1 C/O SPDT	24 Vdc or Vac	0.1–10 s	RE8RA11BTQ ★	10	117.00
		0.3–30 s	RE8RA31BTQ	10	117.00
		3–300 s	RE8RA21BTQ ★	10	117.00
	110–240 Vac	0.1–10 s	RE8RA11FUTQ ★	10	117.00
		0.3–30 s	RE8RA31FUTQ	10	117.00
		3–300 s	RE8RA21FUTQ ★	10	117.00
Self-Powered (Times without power)					
 1 C/O SPDT	24 Vdc or Vac 110–240 Vac	0.05–0.5 s	RE8RB51BUTQ	10	186.00
		0.1–10 s	RE8RB11BUTQ	10	186.00
		0.3–30 s	RE8RB31BUTQ	10	186.00

★ Also available in pack of one; delete TQ from the end of the catalog number. Example: RE8TA11BU.

Table 23.133: Repeat Cycle Timer





Relay Output	Supply Voltages	Timing Range ▲	Catalog Number	Standard Pack Quantity ■	\$ Price
 1 C/O SPDT	24 Vdc or Vac 110–240 Vac	0.1–10 s	RE8CL11BUTQ	10	125.00

Table 23.134: Interval Timer

On Energization					
 1 C/O SPDT	24 Vdc or Vac 110–240 Vac	0.1–10 s	RE8PE11BUTQ	10	108.00
		0.3–30 s	RE8PE31BUTQ	10	108.00
		3–300 s	RE8PE21BUTQ	10	108.00
By Control Contact					
 1 C/O SPDT	24 Vdc or Vac	0.1–10 s	RE8PD11BTQ	10	125.00
		0.3–30 s	RE8PD31BTQ	10	125.00
		3–300 s	RE8PD21BTQ	10	125.00
	110–240 Vac	0.1–10 s	RE8PD11FUTQ	10	125.00
		0.3–30 s	RE8PD31FUTQ	10	125.00
		3–300 s	RE8PD21FUTQ	10	125.00
On De-Energization					
 1 C/O SPDT	24 Vdc or Vac 110–240 Vac	0.05–1 s	RE8PT01BUTQ	10	132.00

▲ For easier adjustment, it is preferable to set the time delay between the maximum value in the range and one tenth of this value. Example: RE8TA11BUTQ timing range 0.1–10 s, recommended use 1–10 s.

■ Orders must specify standard pack quantity or multiples of that quantity.

For technical information, refer to page 23-30.

Table 23.135: On-Delay Timer (Solid State Output)

Power Supply Circuit	Function	Timing Range ♦	Catalog Number	\$ Price
24–240 Vac or Vdc	On-Delay	0.1–10 s	RE9TA11MW	108.00
		0.3–30 s	RE9TA31MW	108.00
		3–300 s	RE9TA21MW	108.00
		40 s–60 min	RE9TA51MW	108.00

Table 23.136: Off-Delay Timer (Solid State Output)

Power Supply Circuit	Function	Timing Range ♦	Catalog Number	\$ Price
24–240 Vac	Off-Delay	0.1–10 s	RE9RA11MW7	156.00
		0.3–30 s	RE9RA31MW7	156.00
		3–300 s	RE9RA21MW7	156.00
		40 s–60 min	RE9RA51MW7	156.00

♦ For easier adjustment, it is preferable to set the time delay between the maximum value in the range and one tenth of this value. Example: RE9TA11MW timing range 0.1–10 s, recommended use 1–10 s.

RoHS Compliant as of date code 0626

For technical information, refer to catalog 9050CT0001.

Square D® General Purpose Plug-In

9050JCK timing relays are designed to provide low-cost timing in a plug-in housing. The Types JCK11 thru 59 provide ±1% repeat accuracy. The Types JCK60 and 70 offer ±0.1% repeat accuracy. These timers are directly interchangeable with many other 8 and 11 pin tube base timers.



9050JCK46V20



9050JCK32V36 with 8501NH7

- Up to ±0.1% repeat accuracy
- Timing from 0.05 seconds to 999 hours
- Available in 5 timing modes
- DPDT contacts (2 N.O. and 2 N.C.)
- 10 A contact rating
- Transient protected
- Hold down spring available
- Variable or fixed time delay
- Horsepower rated
- RoHS compliant

Table 23.137: Variable Time Delay

Knob Adjustable Timing Range	On Delay	\$ Price	Off Delay ■	\$ Price	Off Delay Power Trigger	\$ Price	Interval	\$ Price	One Shot ■	\$ Price	One Shot Power Trigger	\$ Price	Repeat Cycle▲	\$ Price
0.1–10 seconds	JCK11Δ	78.00	JCK21Δ	98.00	JCK21PTΔ	98.00	JCK31Δ	78.00	JCK41Δ	98.00	JCK41PTΔ	98.00	JCK51Δ	140.00
0.3–30 seconds	JCK12Δ	78.00	JCK22Δ	98.00	JCK22PTΔ	98.00	JCK32Δ	78.00	JCK42Δ	98.00	JCK42PTΔ	98.00	JCK52Δ	140.00
0.6–60 seconds	JCK13Δ	78.00	JCK23Δ	98.00	JCK23PTΔ	98.00	JCK33Δ	78.00	JCK43Δ	98.00	JCK43PTΔ	98.00	JCK53Δ	140.00
1.2–120 seconds	JCK14Δ	78.00	JCK24Δ	98.00	JCK24PTΔ	98.00	JCK34Δ	78.00	JCK44Δ	98.00	JCK44PTΔ	98.00	JCK54Δ	140.00
1.8–180 seconds	JCK15Δ	78.00	JCK25Δ	98.00	JCK25PTΔ	98.00	JCK35Δ	78.00	JCK45Δ	98.00	JCK45PTΔ	98.00	JCK55Δ	140.00
0.1–10 minutes	JCK16Δ	87.00	JCK26Δ	107.00	JCK26PTΔ	107.00	JCK36Δ	87.00	JCK46Δ	107.00	JCK46PTΔ	107.00	JCK56Δ	147.00
0.3–30 minutes	JCK17Δ	87.00	JCK27Δ	107.00	JCK27PTΔ	107.00	JCK37Δ	87.00	JCK47Δ	107.00	JCK47PTΔ	107.00	JCK57Δ	98.00
0.6–60 minutes	JCK18Δ	87.00	JCK28Δ	107.00	JCK28PTΔ	107.00	JCK38Δ	87.00	JCK48Δ	107.00	JCK48PTΔ	107.00	JCK58Δ	98.00
1.2–120 minutes	JCK19Δ	87.00	JCK29Δ	107.00	JCK29PTΔ	107.00	JCK39Δ	87.00	JCK49Δ	107.00	JCK49PTΔ	107.00	JCK59Δ	98.00

▲ Two dials are provided for independently adjustable repeat cycle timing ranges.
■ Initiating contact can be up to 50 feet from the timer.

Table 23.138: Fixed Time Delay

Timing Mode	Type	Timing Range (seconds)	\$ Price
On Delay	JCK1F(XXXX)◆Δ	0.1 to 180	78.00
		181 to 3600	87.00
Off Delay ▼	JCK2F(XXXX)◆Δ	0.1 to 180	98.00
		181 to 3600	107.00
Off Delay with Power Trigger	JCK2F(XXXX)PT◆Δ	0.1 to 180	98.00
		181 to 3600	107.00
Interval	JCK3F(XXXX)◆Δ	0.1 to 180	78.00
		181 to 3600	87.00
One Shot ▼	JCK4F(XXXX)◆Δ	0.1 to 180	98.00
		181 to 3600	107.00
One Shot with Power Trigger	JCK4F(XXXX)PT◆Δ	0.1 to 180	98.00
		181 to 3600	107.00
Repeat Cycle	JCK5F(XXXX)◆★Δ	0.1 to 180	140.00
		181 to 3600	147.00

- ◆ (XXXX) denotes the timing period in seconds. Example: Class 9050 Type JCK1F60 is an On Delay timer fixed at 60 seconds.
- ★ Fixed repeat cycle timers can be supplied with the same or different On-Time and Off-Time.
- ▼ Initiating contact can be up to 50 feet from the timer.
- Δ Voltage code must be specified to order this product. Refer to standard voltage codes listed below and insert as shown in How To Order.

Class 8501 Sockets

For sockets, see page 23-13
For DIN rail, see page 24-16

For all 9050JCK timers:

With appropriate 8501NR Socket:



File CCN E78351 NLDX



File Class 214768 3211 07

Without Socket



File CCN E78351 NLDX2



IEC 60947-1 RoHS Compliant as of date code 9050JCK1-5 = 0627 9050JCK6070=0648

Table 23.139: Voltage Codes

Voltage	Code
12 Vac/Vdc	V36
24 Vac/Vdc	V14
48 Vac/Vdc	V17
120 Vac/110 Vdc	V20
240–50/60	V24

Table 23.140: Contact Ratings

AC Volts	AC Amperes					hp	DC Volts	DC Amperes		
	Inductive 35% P.F.			Res. 75% P.F. Make Break and Continuous	Make			Break	Res. Make Break and Continuous	
	Make	Break	Continuous							
120	30	3	10	10	1/3	28	3	3	10	
240	15	1.5	10	10	1/2					

B300, R300, AC15 and DC13

Type JCK60

This On Delay timer uses a 5 position rotary switch to select the timing range. The three pushbutton thumbwheels are used to select the time value.

Table 23.141: Selection and Pricing

Timing Modes	Timing Ranges	Type	\$ Price
On Delay	.01s	JCK60Δ	152.00
	0.1s		
	S		
	0.1m		
	M		
	0.1h		
	H		



Type JCK70

Two 5 position rotary switches are used to select the timing mode and timing range. The three pushbutton thumbwheels are used to select the time value.

Table 23.142: Selection and Pricing

Timing Modes	Timing Range	Type	\$ Price
On Delay Off Delay Interval One Shot Repeat Cycle□	Same as JCK60	JCK70Δ	173.00

□ The repeat cycle mode utilizes the same on-time and off-time.

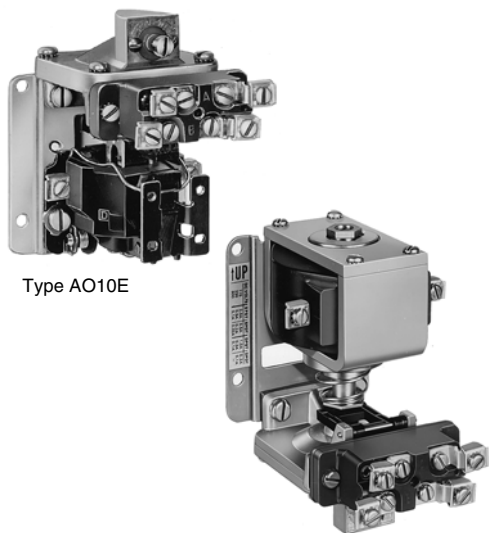

Table 23.143: Class 8501 Hold Down Spring

For use on Class 9050 Type JCK Timers	Class	Type	\$ Price ea.
Hold down spring holds timer in socket during heavy vibration. (See 9050JCK with 8501NH7 photo at the top of this page.)	8501	NH7	8.30

Table 23.144: How to Order

To Order Specify:	Catalog Number		
• Class Number	Class	Type	Voltage Code
• Type Number	9050	JCK11	V20
• Voltage Code			



Type AO10E

Type HO10E

Square D® Pneumatic

- One minute timing ± 10% repeat accuracy
- SPDT or DPDT instantaneous contacts (Type A only)
- On and Off Delay, convertible
- SPDT or DPDT timed contacts
- Small size
- Low cost

Table 23.145: Selection and Pricing

Mode of Operation	Number of Contacts				AC Operated		DC Operated	
	Time Delay		Instantaneous		Open Type	\$ Price	Open Type	\$ Price
	N.O.	N.C.	N.O.	N.C.				
On Delay Convertible	1	1	0	0	AO10E▲	504.00	HO10E▲	777.00
			1	1	AO11E▲	629.00	—	—
			2	2	AO12E▲	675.00	—	—
Off Delay Convertible	2	2	0	0	AO20E▲	549.00	HO20E▲	569.00
			1	1	AO21E▲	675.00	—	—
			2	2	AO22E▲	720.00	—	—
On and Off Delay Double Headed	1 per Head	1 per Head	0	0	AO10D▲	504.00	HO10D▲	518.00
			1	1	AO11D▲	629.00	—	—
			2	2	AO12D▲	675.00	—	—
On and Off Delay Double Headed	2 per Head	2 per Head	0	0	AO20D▲	549.00	HO20D▲	569.00
			1	1	AO21D▲	675.00	—	—
			2	2	AO22D▲	720.00	—	—
On and Off Delay Double Headed	1 per Head	1 per Head	0	0	AO110DE▲	818.00	—	—
On and Off Delay Double Headed	2 per Head	2 per Head	0	0	AO220DE▲	909.00	—	—

▲ Voltage code must be specified to order this product. Refer to standard voltage codes listed below and insert as shown in How To Order.

Types A and H



File E78403
CCN NKCR



File 060905
Class 3211 03

Table 23.146: Accessories

Class	Type	For Timing Relay	Description	\$ Price
9991	UE6	Type A (single headed) Type H	Separate NEMA 1 Enclosure	99.00
9999	R33■	Type A	SPDT Instantaneous Contact Kits (1 N.O., 1 N.C.)	126.00
9999	R34■	Type A	DPDT Instantaneous Contact Kits (2 N.O., 2 N.C.)	171.00

■ Instantaneous contact kits contain a snap switch, mounting bracket and screws for field installation.

Table 23.147: Voltage Codes

AC Voltages	Code	DC Voltages	Code
24-60	V01	6	V50
24-50	V12	12	V51
120-60/110-50	V02	24	V53
208-60	V08	48	V56
240-60/220-50	V03	115	V61
277-60	V04	230/250	V66
480-60/440-50	V06		
600-60/550-50	V07		

Timing Modes: On Delay or Off Delay, convertible. On Delay types can be wired for interval-maintained start or repeat cycle (sequencing using two devices).

Timed and Instantaneous Output Contacts: SPDT or DPDT snap switch.

Contacts of each pole must be used on same polarity.

Repeat Accuracy:

Under constant temperature (Per NEMA Standard ICS 5-1993). ±10% to 1 minute max.

Timing Range: Type A: 0.1 second to 1 minute. Type H: 0.15 second to 1 minute.

Reset Time: Type A: On Delay 29 ms, Off Delay 27 ms average. Type H: On Delay 50 ms, Off Delay 70 ms average.

Operating Temperature Range: 20°C to 40°C (68°F to 104°F)

Operating Voltages/Voltage Range:

Type A—6 through 600 volts AC, +10%, -15% of nominal

Type H—6 through 250 volts DC, +10%, -20% of nominal

Table 23.148: DC Replacement Coils

Coil Voltage	Coil Part Number	Coil Burden Watts	\$ Price
6 Vdc	4491S1W21	14	228.00
12 Vdc	4491S1W24		
24 Vdc	4491S1W27		
48 Vdc	4491S1W30		
115/125 Vdc	4491S1W34		
230/250 Vdc	4491S1W37		

Table 23.149: AC Replacement Coils

Coil Voltage	Coil Part Number		Coil (Volt-Amperes) ♦			\$ Price
	60 Hz	50 Hz	Inrush 60 Hz	Inrush 50 Hz	Sealed	
24 Vac	2959S49W25A	2959S49W25B	74	68	17	144.00
110/115 Vac	2959S49W31B	2959S49W32A				
120 Vac	2959S49W32A	2959S49W32B				
208 Vac	2959S49W34A	2959S49W34B				
220 Vac	2959S49W34B	2959S49W35A				
240 Vac	2959S49W35A	2959S49W35B				
277 Vac	2959S49W35B	—				
440 Vac	2959S49W37B	2959S49W38A				
480 Vac	2959S49W38A	2959S49W38B				
550 Vac	2959S49W38B	2959S49W39A				

♦ 6 to 24 Vac coils have VA ratings 120% of the values shown

Table 23.150: Contact Ratings

Contacts	Volts	AC Ratings						Volts	DC Ratings		
		Inductive 35% Power Factor				Resistive 75% Power Factor			Inductive and Resistive		
		Make		Break		Continuous Amperes	Make, Break and Continuous Amperes		Make and Break Amperes		Continuous Amperes
		Amperes	VA	Amperes	VA				Single Throw	Double Throw	
SPDT Timed or Instantaneous	120	40	—	15	—	15	15	2.0	0.5	15	
	240	20	—	10	—	15	15	0.5	0.2	15	
	480	10	—	6	—	15	15	0.1	0.02	15	
	600	8	—	5	—	15	15	—	—	—	
DPDT Timed or Instantaneous	120	30	3600	3	360	10	10	1.0	0.2	10	
	240	15	3600	1.5	360	10	10	0.3	0.1	10	
	480	7.5	3600	0.75	360	10	10	0.1	—	10	
	600	6	3600	0.6	360	10	10	—	—	—	



RM17JC00MW

New! **Zelio® Current Measurement Relays**

Zelio Current Measurement Relays are designed to measure under and overcurrent, without external sensors. Current measurement relays enable continuous monitoring of the operation of electrical and mechanical loads such as motors and resistors. They are DIN rail mountable and the control status is indicated by an LED.

RM17JC Current Control Relay

- Monitors a.c. currents
- Designed to monitor overcurrent
- Equipped with an integrated current transformer

RM35JA Current Control Relays

- Selection between overcurrent or undercurrent
- Automatic d.c. or a.c. recognition
- Selectable memory function

Table 23.151:

Supply Voltage	Measurement Range		Output 5Amps	Width		Catalog Number	\$ Price
	Range▲	Terminals		Inches	mm		
24–240 Vac/dc	2–20 A	N/A	1 C/O	0.69	17.50	RM17JC00MW	155.00
	2–20 mA	E1-M	2 C/O	1.38	35.00	RM35JA31MW	176.00
	10–100 mA	E2-M					
	50–500 mA	E3-M					
	0.15–1.5 A	E1-M					
	0.5–5 A	E2-M					
1.5–15 A	E3-M	RM35JA32MW	210.00				

▲ Above 15A, a current transformer can be connected (for RM35JA3+MW). See page 57 of the catalog for suggested wiring.

Table 23.152: Output Characteristics and Measurement Circuit Characteristics

Type of Relay	RM17JC00MW	RM35JA31MW	RM35JA32MW
Setting accuracy	Plus or minus 10% of the full scale value		
Repeat accuracy (with constant parameters)	Plus or minus 0.5%		
Hysteresis	15% of the threshold setting, fixed	5 to 50% of the threshold setting, adjustable	
Time delay accuracy (with constant parameters)	N/A	plus or minus 2%	
Time delay on pick-up	500ms	300ms	
Conforming to standards	NF EN 60255-6		
Ambient air temperature around the device	Storage	-40 to 158 degrees F (-40 to +70°C)	
	Operational	-4 to 122 degrees F (-20 to +50°C)	



RM35JA31MW



RM35JA32MW

Approvals:



File E173076
CNN NRNT



File Class 217698
3211 07



CE: 73/23/EEC and
EMC 89/336/EEC
GL, C-Tick, GOST,
RoHS

Approximate Dimensions

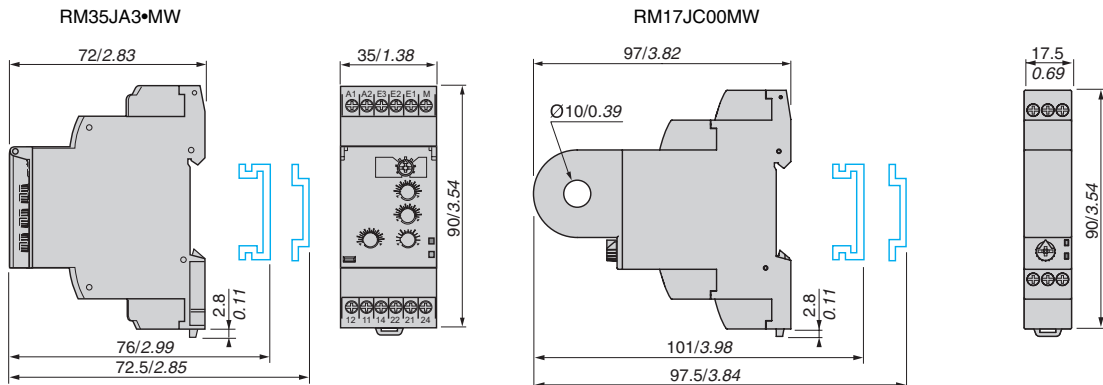

Dual Dimensions: **INCHES**
Millimeters

New! **Zelio® Phase Measurement Relays**

Zelio Phase Measurement Relays monitor their own power supply. Relay status is indicated by an LED and they are DIN rail mountable.

RM17TG•0 measurement and control relays are for monitoring of 3-phase supplies for the correct sequencing of phases L1, L2, and L3, as well as the total loss of one or more phases.



RM17TG•0

Table 23.153: 3-Phase supply control relays

Supply Voltage	Detection Threshold	Output 5 Amps	Width		Catalog Number	\$ Price
			inches	mm		
208–480 Vac	<100 Vac	1 C/O	0.69	17.50	RM17TG00	135.00
208–440 Vac		2 C/O			RM17TG20	149.00



RM17TA00

Table 23.154: Multifunction 3-phase supply control relays

Supply Voltage	Voltage Range	Output 5 Amps	Width		Catalog Number	\$ Price
			inch	mm		
208–480 Vac	Selectable voltages: 208, 220, 380, 400, 415, 440, 480	1 C/O	0.69	17.50	RM17T100	162.00
					RM17TA00	210.00
					RM17TU00	156.00
					RM17TE00	258.00

Table 23.155: RM17TT, RM17TA, RM17TU, and RM17TE multifunction control relays monitor the following on 3-phase supplies:

Function	RM17TT	RM17TA	RM17TU	RM17TE
Sequence of phases L1, L2 and L3	Yes	Yes	Yes	Yes
Phase failure with regeneration (0.7 x selected voltage range)	Yes	Yes	Yes	Yes
Asymmetry (phase imbalance)	No	Yes	No	Yes
Undervoltage	No	No	Yes	No
Oversvoltage and undervoltage	No	No	No	Yes



RM17TE00

Table 23.156: 3-phase supply and motor temperature control relays

Supply Voltage	Measurement Range	Output 5 Amps	Width		Catalog Number	\$ Price
			inch	mm		
24–240 Vac/Vdc	208–480 Vac	2 N.O.	1.38	35.00	RM35TM50MW	263.00
					RM35TM250MW	275.00

Table 23.157: RM35TM control relays monitor the following on 3-phase supplies:

Function	RM35TM50MW	RM35TM250MW
Sequence of phases L1, L2 and L3	Yes	Yes
Phase failure	Yes	Yes
Motor temperature via PTC probe	Yes	Yes
Selection (with or without memory)	No	Yes
Test-reset button	No	Yes

RM35TF30 measurement and control relay is for monitoring of phase sequence, phase failure, asymmetry, undervoltage and oversvoltage in window mode.

Table 23.158: Multifunction 3-phase supply control relays

Supply Voltage	Measurement Range	Output 5 Amps	Width		Catalog Number	\$ Price
			inch	mm		
24–240 Vac/Vdc	194–528 Vac	2 C/O	1.38	35.00	RM35TF30	324.00



RM35TM••MW

Approvals:



File E173076
CNV NRNT



File Class 217698
3211 07



CE: 73/23/EEC and
EMC 89/336/EEC

GL, C-Tick, GOST,
RoHS

Approximate Dimensions



RM35TF30

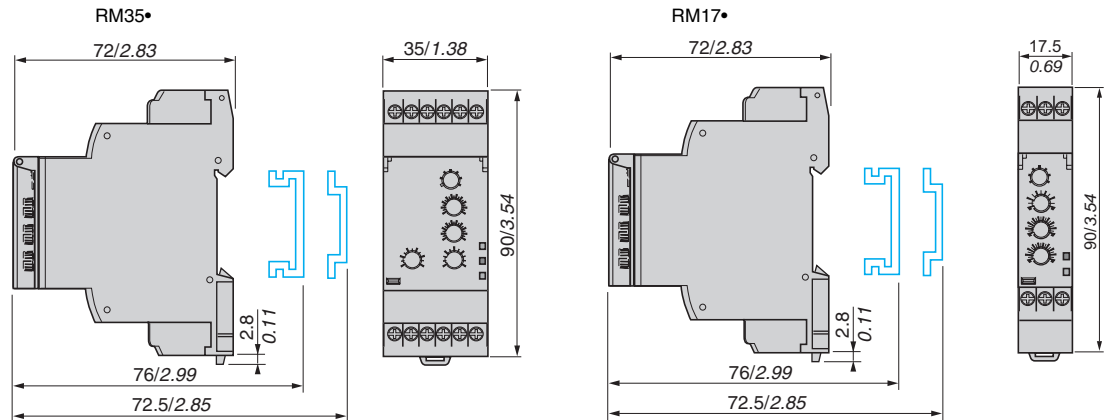
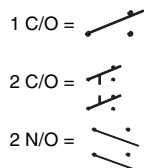

Dual Dimensions: INCHES
Millimeters

New! **Zelio® Voltage Measurement Relays**

Zelio Voltage Measurement Relays are DIN rail mountable and relay status is indicated by an LED.

Single phase and d.c. voltage measurement and control relays RM17UAS•• and RM17UBE•• monitor:

- Overvoltage
- Undervoltage
- Overvoltage and undervoltage (window mode)
- Nominal voltages



RM17UB310



RM35UB3•••



RM17UAS••

Table 23.159: Single-phase and d.c. voltage control relays

Supply Voltage	Ranges Controlled	Output 5Amps	Width		Catalog Number	\$ Price
			inches	mm		
12 Vdc	9–15 Vdc	1 C/O	0.69	17.50	RM17UAS14▲	164.00
24–48 Vac/Vdc	20–80 Vac/Vdc				RM17UAS16▲	164.00
110–240 Vac/Vdc	65–260 Vac/Vdc				RM17UAS15▲	173.00
24–48 Vac/Vdc	20–80 Vac/Vdc				RM17UBE16■	164.00
110–240 Vac/Vdc	65–260 Vac/Vdc				RM17UBE15■	173.00

- ▲ Provides overvoltage or undervoltage protection.
- Provides overvoltage and undervoltage protection in window mode.

Multifunction voltage control relays RM35UA1•MW monitor both a.c. and d.c. voltages.

- Automatic Vdc or Vac recognition
- Selection between overvoltage and undervoltage

Table 23.160: Multifunction voltage control relays

Supply Voltage	Measurement Range		Output 5 Amps	Width		Catalog Number	\$ Price
	Range★	Terminals		inch	mm		
24–240 Vac/Vdc	0.05–0.5 V	E1-M	2 C/O	1.38	35.00	RM35UA11MW	186.00
	0.3–3 V	E2-M					
	0.5–5	E3-M					
	1–10	E1-M				RM35UA12MW	186.00
	5–50	E2-M					
	10–100	E3-M					
	15–150	E1-M				RM35UA13MW	186.00
	30–300	E2-M					
	60–600	E3-M					

3-phase voltage control relays monitor:

- Failure of one or more phases
- Voltage between phases
- Absence of neutral
- Voltage between phases and neutral
- Overvoltage and undervoltage

Table 23.161: Three-phase voltage control relays

Rated 3-Phase Supply Voltage Vac	Measurement Range	Output 5 Amps	Width		Catalog Number	\$ Price
			inch	mm		
220–480 phase-phase	195–528 Vac	1 C/O + 1 C/O 1 per threshold	1.38	35.00	RM35UB330♦	272.00
120–277 phase-neutral	183–528 Vac	1 C/O	0.69	17.50	RM17UB310♦	224.00
120–277 phase-neutral	114–329 Vac	1 C/O + 1 C/O 1 per threshold	1.38	35.00	RM35UB3N30★	302.00

- ♦ Provides overvoltage and undervoltage protection between phases.
- ★ Provides overvoltage and undervoltage protection between phases and neutral and absence of neutral.

Approvals:



File E173076
CNN NRNT



File 217698
Class 3211 07



CE: 73/23/EEC and
EMC 89/336/EEC

GL, C-Tick,
GOST, RoHS



RM35UA1•MW

Approximate Dimensions

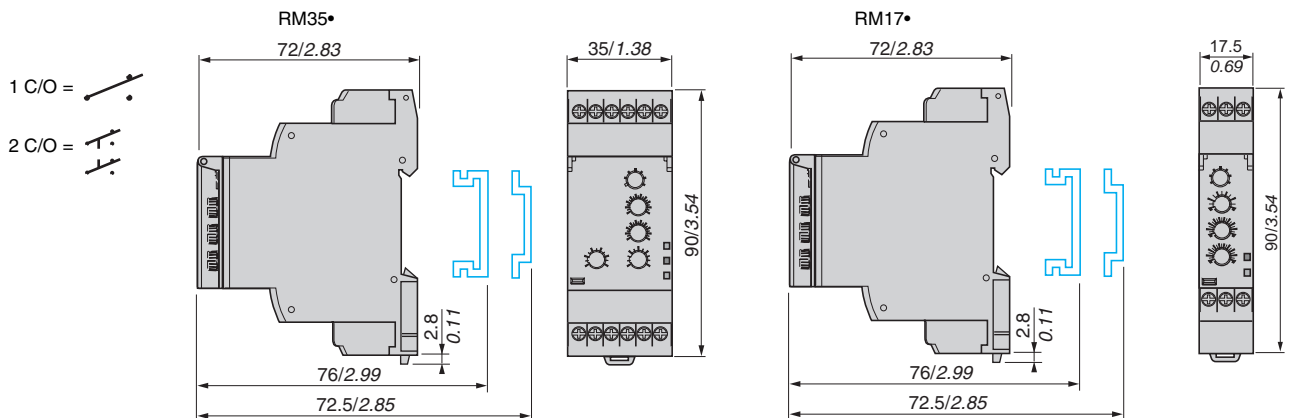

Dual Dimensions: INCHES
Millimeters

New!

Zelio® Level Control Relays and Zelio® Pump Control Relays

Zelio level control relays control one or two levels with fill or empty function. The settings are protected by a sealable cover, control status is indicated by an LED, and they are DIN rail mountable. RM35LM is designed to control levels of conductive liquid, and RM35LV is designed to control levels of other materials.



RM35LM33MW



RM35LV14MW



RM79696043



LA9RM201



RM79696006



RM35BA10

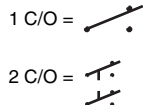

Application examples for RM35LM:

- Detecting pump seal failures
- Spring, town, industrial and sea water
- Metallic salt, acid or base solutions
- Liquid fertilizers
- Non-concentrated alcohol (<40%)

- Liquids in the food-processing industry: milk, beer, coffee, etc.

Application examples for RM35LV:

- Chemically pure water
- Fuels, liquid gasses (inflammable)
- Oil, concentrated alcohol (>40%)
- Ethylene, glycol, paraffin, varnish and paints

Table 23.162: Level Control Relays

Time Delay on Crossing the Threshold	Function	Output Relay	Supply Voltage 50/60 Hz	Measurement Ranges	Catalog Number	\$ Price
0.1–5 seconds, 0 + 10%	Detection by resistive probes	2 C/O, 5A	24–240 Vac/Vdc	250 Ω–5 k Ω	RM35LM33MW	137.00
				5 k Ω–100 k Ω		
	Detection by discrete sensors	1 C/O, 5A		50 k Ω–1 M Ω		

Table 23.163: Probes

Application	No. of probes	Operating temperature		Maximum pressure kg/cm ²	Catalog Number	\$ Price
		°F	°C			
Recommended for drink vending machines and where installation space is limited (stainless steel)▲	3	176	80	2	RM79696044	93.00
Suitable for boilers, pressure vessels, and under high temperature conditions (1) (304 stainless steel)▲	1	392	25	200	RM79696014	113.00

▲ 3/8" BSP mounting thread with hexagonal head. Use a 24mm spanner for tightening.

Table 23.164: Probes

Description	Catalog Number	\$ Price
Protected probe for mounting by suspension, protective shell PUC (S7) Electrode: stainless steel	RM79696043	68.00
Liquid level control probe, suspended by cable, maximum operating temperature 212°F/100°C■	LA9RM201	98.00

■ 3/8" BSP mounting head.

Table 23.165: Electrode Holders

Description	Material	Catalog Number	\$ Price
Electrode for use up to 662°F (350°C)	Stainless steel isolated by ceramic	RM79696006	74.00

Pump control relay RM35BA10 can operate on a single-phase or 3-phase supply. It incorporates three functions in a signal unit:

- Over and under current measurement
- Phase presence control
- Single or three phase

It has two operating modes which are designed to control a pump via two external signal inputs (Y1 Y2). These two signals are controlled by volt-free contacts. Control inputs Y1 and Y2 can be connected to:

- Level sensor
- Level relay
- Pressure sensor
- Push button

Table 23.166: Pump Control Relay

Description	Current Range Controlled	Supply Voltage	Output	Catalog Number	\$ Price
Pump Control Relay	1–10 A	208–480 Vac, 3 phase	1 C/O 5 A	RM35BA10	338.00
		230, single-phase			

Approvals:



File E173076
CNN NRNT



File Class 217698
3211 07



CE: 73/23/EEC and
EMC 89/336/EEC

GL, C-Tick, GOST,
RoHS

Approximate Dimensions

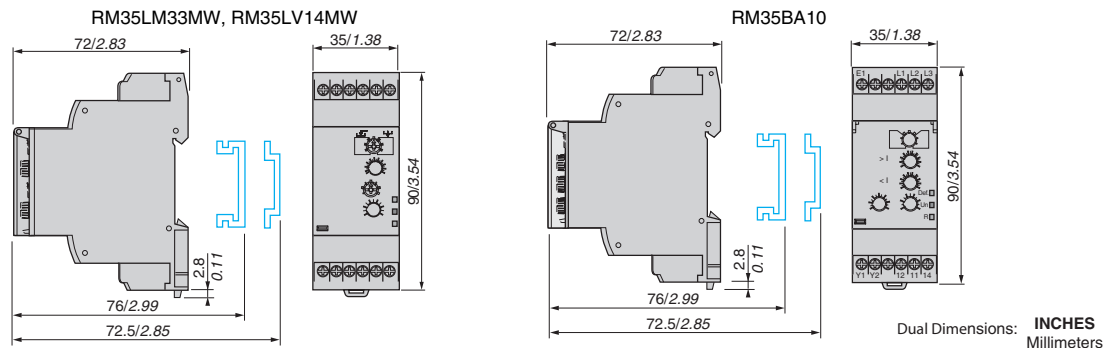

RELAYS AND TIMERS 23



RM35S0MW

New! Zelio® Speed Control Relays, Zelio® Frequency Control Relays, and Zelio® Temperature Control Relays

Zelio speed control relay RM35SOMW monitors underspeed and overspeed, with or without memory, with inhibition by an external contact. It operates with either N.O. or N.C. sensors. Adjustable time between impulses is 0.05s to 10m. Power-on inhibition time is adjustable from 0.6 to 60s. Inhibition is controlled by an external contact. Settings are protected by a sealable cover, control status is indicated by an LED, and it is DIN rail mountable.

Table 23.167: Speed Control Relay

Function	Time Delay	Measurement Input	Supply	Output	Catalog Number	\$ Price
Underspeed	0.05s–10min	3-wire PNP or NPN proximity sensor	24–240 Vac/Vdc	1 C/O 5A	RM35S0MW	258.00
Overspeed		Namur proximity sensor 0–30 V voltage Volt-free contact				



RM35HZ21FM

Zelio frequency control relay RM35HZ monitors its own supply voltage. Settings are protected by a sealable cover, control status is indicated by an LED, and it is DIN rail mountable.

Table 23.168: Frequency Control Relay

Function	Controlled	Supply Voltage	Output	Catalog Number	\$ Price
Over frequency and under frequency (50 or 60 Hz)	40–60 Hz (50 Hz) / 50–70 Hz (60 Hz)	120–277 Vac	1 C/O + 1 C/O 5A	RM35HZ21FM	264.00



RM35AT0MW

Zelio temperature control relays are designed for monitoring the temperature in elevator (lift) pulley rooms, in compliance with directive EN81. For use with PT100 input (customer supplied). Features adjustable control, control status is indicated by an LED, and it is DIN rail mountable.

Table 23.169: Temperature Control Relays

Function	Supply Voltage	Vac	Output	Catalog Number	\$ Price
Over temperature 93 to 114°F (34 to 46°C)	24–240 Vac/Vdc	—	1 C/O 5A	RM35ATL0MW	167.00
Under temperature 30 to 51°F (-1 to 11°C)		—	2 N.O. 5A	RM35ATR5MW	179.00
Over temperature 93 to 114°F (34 to 46°C)		208–480 Vac	2 N.O. 5A	RM35ATW5MW	282.00
Under temperature 30 to 51°F (-1 to 11°C)		208–480 Vac	2 N.O. 5A		
Phase sequence					
Phase failure					

Approvals:



File CNN E173076 NRNT



File Class 217698 3211 07



CE: 73/23/EEC and EMC 89/336/EEC

GL, C-Tick, GOST, RoHS

Approximate Dimensions

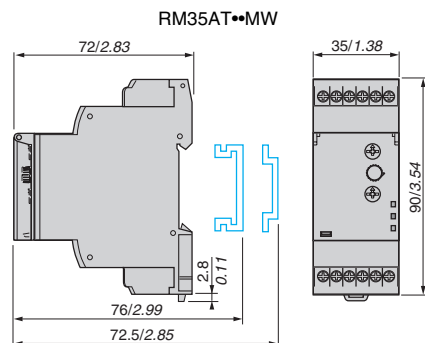
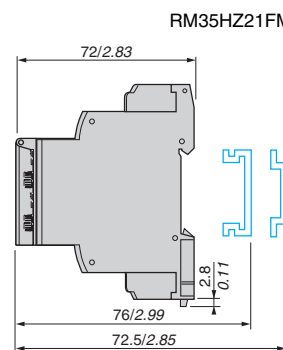
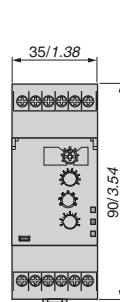
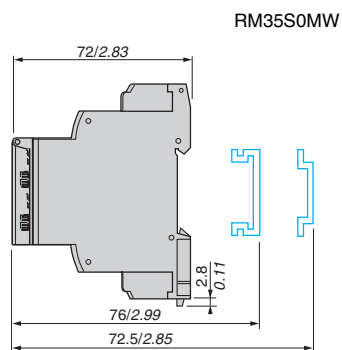
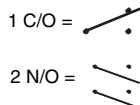

Dual Dimensions: INCHES
Millimeters

Square D® Phase Failure Relays

8430 phase failure relays offer the reliability and accuracy of solid state circuitry with the isolation of hard output contacts.

Phase Abnormality Definitions



Phase Loss: This condition occurs when one line of a 3 phase system is completely lost.

Phase Unbalance: This condition occurs when the voltage in one line of a 3 phase system drops below the voltage in the remaining two lines.

Phase Reversal: This condition occurs when two of three lines in a 3 phase system are switched. This incorrect connection will cause a motor to rotate in the reverse direction.

Undervoltage: This condition occurs when the voltage in all three lines of a 3 phase system drop simultaneously.

Table 23.170:

Class/Type	Protects Against				Description	Contact Arrangement	Nominal Voltage	Type	\$ Price
	Phase Loss	Phase Unbalance	Phase Reversal	Under Voltage					
 8430 MPS	Yes	Yes	Yes	Yes	Phase Failure and Undervoltage Relay The Type MPS is a socket mounted, voltage sensing phase failure relay. The undervoltage setting is adjustable from 75% to 100% of normal voltage. The relay is UL Listed with the appropriate socket (see socket selection on page 23-13). The 240 V rated, SPDT output contacts change state upon phase failure, undervoltage, phase reversal or phase unbalance of 10% or greater. Response time delay is 3 seconds.	SPDT	240-60	MPSV24	329.00
							480-60	MPSV29	
 8430 MPD	Yes	Yes	Yes	Yes	Phase Failure and Undervoltage Relay The Type MPD offers the same protection as the Type MPS plus the following features: DPDT 600 V rated output contacts, locking potentiometer undervoltage adjustment and an LED indicating "relay energized." Can be mounted directly to a panel or to 8501 XM track (see page 23-23).	DPDT	120-60	MPDV20	732.00
							240-60	MPDV24	
							480-60	MPDV29	
							600-60	MPDV32	

Note: For 8430 MPS Sockets, see page 23-13.

Table 23.171: Operating Data

Power Consumption	Type MPS	5.5 VA
	Type MPD	7 VA
Ambient Temperature	+23°F to 122°F -5°C to 50°C	

Devices are auto reset, so 3 wire control should be used to accomplish safe operation of equipment.



MPS: File E78403 CCN NLDX provided the proper socket is used. 8430MPSV24 - 8501 NR51 or NR52 socket (see page 23-13). 8430MPSV29 - 8501 NR82 socket (see page 23-13).



MPD: File E78403 CCN NLDX

File E78403 CCN NLDX2 without using the sockets listed.



File 060905 - 174 Class 3211-03

Table 23.172: Contact Ratings

Type	Contacts	Maximum Control Circuit Voltage	AC Ratings			
			Inductive		Resistive	
			Make VA	Break VA	Make & Break Amperes	Thermal Continuous Current
MPS	SPDT	120	1800	180	5	5
		240	1800	180	5	5
MPD	DPDT	120	3400	340	5	5
		240	3600	360	5	5
		480	3600	360	2.5	5
		600	3600	360	2.5	5

Table 23.173: How to Order

To Order Specify:	Catalog Number		
• Class Number	Class	Type	Voltage Code
• Type Number			
• Voltage Code	8430	MPS	V24

For Mounting Track for the 8430 MPS relays page 23-23

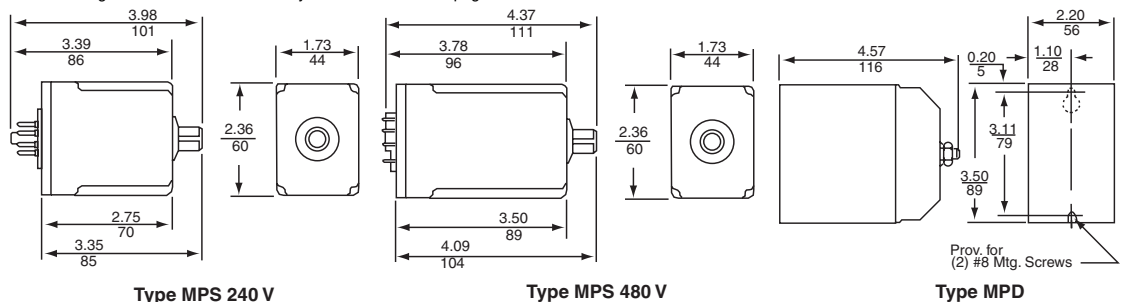



RC87610050

Zelio® Counters

This type of counter is typically used on simple machines to keep a running total of the number of cycles the machine has performed or the total amount of time that a machine has been running. This information can be very useful in a preventative maintenance program.

Totalizing Counters

A totalizing counter is used to count electrical pulses or contact closings. The display will show the value and update this value after each pulse. They count up only and can be reset on the front of the device or remotely.

Table 23.174: Totalizing Counters

	Description	Catalog Number	\$ Price
24 x 48 mm Totalizing Counter	8 Digit LCD, 40 Hz input	RC87610050	116.00
	8 Digit LCD, 14 or 100 Hz input	RC87610240	140.00
	8 Digit LCD, 14 Hz input	RC87610250	140.00
	8 Digit LCD, 40 Hz or 7 kHz input	RC87610340	42.30



RC87610340

Hour Counters

An hour counter is used to count the elapsed time and display the value. They count up only and can be reset on the front of the device or remotely.

Table 23.175: Hour Counters

	Description	Catalog Number	\$ Price
24 x 48mm Totalizing Counters	6 Digit LCD, 0–99,999.9 Hours Counted when voltage is applied	RC87610150	116.00
	6 Digit LCD, 0–99,999.9 Hours Counted when a contact is closed	RC87610440	42.30



RC87610050

Accessories

These adaptors are used to mount above counters in holes other than 24x48 mm.

Table 23.176: Mounting Adapters

Description	Dimensions		Catalog Number	\$ Price
	in.	mm		
Adaptors for panel cut-out	0.98x1.96	25x50	RC26546829	5.00
	1.77x1.77	45x45	RC26546830	5.00
	1.96 diameter	50 diameter	RC26546831	9.90

Table 23.177: How to Order

To Order Specify:	Catalog Number
• Catalog Number	RC87610050



File E173076
CCN NRNT, NRNT7



File Class 217698
3211 07



IEC 61010

Approximate Dimensions

Table 23.178:

RC87610050	RC87610240 / RC87610250
RC87610340 / RC87610440	RC87610150

Table 23.179:

RC26546830

Panel cut-out

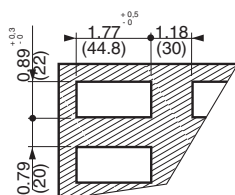

New!

Phaseo™ DC Power Supply

Phaseo switch mode power supplies are totally electronic and their output voltage is regulated. They offer:

- Compact size
- SEMI F47 compliance for many voltages (For more details, see www.Schneider-Electric.us)

For use with Universal power supplies, see optional function modules in catalog 8440CT0601, which offer a set of solutions to meet the needs for continuity of service such as:

- Immunity to microbreaks
- Voltage holding during power outages
- Voltage holding during power supply equipment failure

Table 23.180: Modular, Single Phase

Meets all the needs of simple automation systems with power ratings from 7 to 60 W and an output voltage of 5 Vdc, 12 Vdc, or 24 Vdc.



ABL8MEM12020

Input Voltage (Vac)	Output Voltage (Vdc)	Nominal Current (I)	Protection Reset	Catalog Number	\$ Price	
100-240	5	4	Auto	ABL8MEM05040	128.	
	12	2		ABL8MEM12020	132.	
	24			0.3	ABL8MEM24003	71.
				0.6	ABL8MEM24006	105.
				1.2	ABL8MEM24012	141.
				2.5	ABL7RM24025	180.



ABL8REM24030

Table 23.181: Optimum, Single Phase

The low-cost solution for applications supplied at 12 Vdc, 24 Vdc, or 48 Vdc and requiring currents between 3 and 5 A.

Input Voltage (Vac)	Output Voltage (Vdc)	Nominal Current (I)	Protection Reset	Catalog Number	\$ Price
100-240	12	5	Auto	ABL7RP1205	360.
	24	3		ABL8REM24030	195.
		5		ABL8REM24050	300.
	48	3		ABL7RP4803	225.



ABL8RPS24100

Table 23.182: Universal, Single Phase

Adapts to the majority of power distribution systems with power ratings from 72 to 480 W at 24 Vdc. The same power supply can be connected phase-to-neutral (N-L1) or phase-to-phase (L1-L2) for line supplies ranging from 100 to 500 Vac nominal. Energy reserve, diagnostics, and choice of manual or auto reset are integrated into these units.

Input Voltage (Vac)	Output Voltage (Vdc)	Nominal Current (I)	Auto-Protection Reset	Catalog Number	\$ Price
100-120 / 200-500	24	3	Auto/Manual	ABL8RPS24030	270.
		5		ABL8RPS24050	360.
		10		ABL8RPS24100	525.
100-120 / 200-240		20		ABL8RPM24200	716.



ABL8WPS24200

Table 23.183: Universal, Three Phase

This three-phase, 480 to 960 W, 24 Vdc output offering is particularly suited for complex machines and processes. Energy reserve, diagnostics and choice of manual or auto reset are integrated into these units.

Input Voltage (Vac)	Output Voltage (Vdc)	Nominal Current (I)	Auto-Protection Reset	Catalog Number	\$ Price
380-500	24	20	Auto/Manual	ABL8WPS24200	735.
		40		ABL8WPS24400	1173.

Table 23.184: Dedicated, Single Phase

Designed for integration into repetitive equipment with power ratings from 60 to 240 W and an output voltage of 12 Vdc or 24 Vdc.

Input Voltage (Vac)	Output Voltage (Vdc)	Nominal Current (I)	Protection Reset	Catalog Number	\$ Price
100-240▲	12	5	Auto	ABL1REM12050	113.
	24	2.5		ABL1REM24025	93.
100-120 / 200-240■		24		4.2	ABL1REM24042
	6.2			ABL1REM24062	143.
100-240▲	24	10	Auto	ABL1REM24100	206.
		100-120 / 200-240■		12	8.3
24	4.2			ABL1RPM24042	158.
	100-120 / 200-240■	24		6.2	ABL1RPM24062
10				ABL1RPM24100	270.

▲ Compatible input voltage 120-370 Vdc not indicated on the product.

■ Compatible input voltage 180-370 Vdc not indicated on the product.



ABL1RPM24042



ABL1RPM24100

Approvals:



File CCN E164867, NMTR, NMTR7



File CCN E164867, NMTR2, NMTR8



File Class 238438, 5311-87, 5311-07



RoHS Compliant

See www.Schneider-Electric.com for UL and CSA compliances.

For additional information, refer to Catalog #8440CT0601.

Zelio® Analog Interface Modules

The Zelio Analog range of converters is designed to convert signals emitted by sensors or electrical measurement devices, into standard electrical signals that are compatible with automation platforms and controllers. They also allow the connection distance between a sensor and a measurement device to be increased, for example, between a thermocouple and a programmable controller



RMTJ40BD



RMTK90BD



RMPT70BD



RMPT13BD



RMCN22BD

Table 23.185: Converters for Type J and K type thermocouples—supply voltage 24 Vdc ± 20%, non-isolated

Type	Temperature Range		Switchable Output Signals	Catalog Number	\$ Price
	°F	°C			
Type J	32–302	0–150	0–10 V, 0–20 mA, 4–20 mA	RMTJ40BD	168.00
	32–572	0–300	0–10 V, 0–20 mA, 4–20 mA	RMTJ60BD	168.00
	32–1112	0–600	0–10 V, 0–20 mA, 4–20 mA	RMTJ80BD	168.00
Type K	32–1112	0–600	0–10 V, 0–20 mA, 4–20 mA	RMTK80BD	168.00
	32–2192	0–1200	0–10 V, 0–20 mA, 4–20 mA	RMTK90BD	168.00

Table 23.186: Converters for Universal Pt100 probes—supply voltage 24 Vdc ± 20%, non-isolated

Type	Temperature Range		Switchable Output Signals	Catalog Number	\$ Price
	°F	°C			
Pt100 2-wire, 3-wire, and 4-wire	- 40–104	- 40–40	0–10 V, 0–20 mA, 4–20 mA	RMPT10BD	168.00
	- 148–212	- 100–100	0–10 V, 0–20 mA, 4–20 mA	RMPT20BD	168.00
	32–212	0–100	0–10 V, 0–20 mA, 4–20 mA	RMPT30BD	168.00
	32–482	0–250	0–10 V, 0–20 mA, 4–20 mA	RMPT50BD	168.00
	32–932	0–500	0–10 V, 0–20 mA, 4–20 mA	RMPT70BD	168.00

Table 23.187: Converters for Optimum Pt100 probes▲—supply voltage 24 Vdc ± 20%, non-isolated

Type	Temperature Range		Switchable Output Signals	Catalog Number	\$ Price
	°F	°C			
Pt100 2-wire, 3-wire, and 4-wire	- 40–104	- 40–40	0–10 V or 4–20 mA	RMPT13BD	134.00
	- 148–212	- 100–100	0–10 V or 4–20 mA	RMPT23BD	134.00
	32–212	0–100	0–10 V or 4–20 mA	RMPT33BD	134.00
	32–482	0–250	0–10 V or 4–20 mA	RMPT53BD	134.00
	32–932	0–500	0–10 V or 4–20 mA	RMPT73BD	134.00

▲ Converters dedicated to Zelio Logic smart relays.

Table 23.188: Universal Voltage/Current Converters

Type	Input signal	Output signal	Catalog Number	\$ Price
Supply voltage 24 Vdc ± 20%, non-isolated	0–10 V or 4–20 mA	0–10 V or 4–20 mA	RMCN22BD	113.00
Supply voltage 24 Vdc ± 20%, isolated	0–10 V, ± 10 V, 0–20 mA, 4–20 mA	Switchable: 0–10 V, ± 10 V, 0–20 mA, 4–20 mA	RMCL55BD	168.00
	0–50 V, 0–300 V, 0–500 V DC or AC, 50/60 Hz	Switchable: 0–10 V, 0–20 mA, 4–20 mA	RMCV60BD	183.00
	0–1.5 A, 0–5 A, 0–15 A DC or AC, 50/60 Hz	0–10 V, 0–20 mA, 4–20 mA	RMCA61BD	183.00

Approvals:

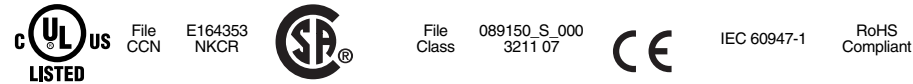



Table 23.189: How to Order

To Order Specify:	Catalog Number
• Catalog Number	RMCN22BD

Zelio® Logic 2 Smart Relays



Zelio® Logic 2 smart relays meet the demands of applications that require more flexibility than a simple relay, timer, or counter, but are too small or simple for the smallest Nano PLC. The Zelio Logic SR2 range is an exact replacement for the obsolete SR1 range, but with an expanded feature set. Designed to accept control outputs just like a relay, Zelio Logic 2 features dual language capability, using either Function Block Diagramming (FBD) or Ladder Logic Programming (LL), and can be programmed easily by using either the front panel or by using ZelioSoft software.

Table 23.190: Compact Smart Relays with Display, DC Power Supply

								
Supply voltage	12 Vdc			24 Vdc				
Number of inputs/outputs	12	20	10	12	12	20	20	20
Number of inputs	Discrete inputs		8	12	6	8	12	12
	Including 0-10 V analog inputs		4	6	—	4	4	2
Number of outputs	4 relay	8 relay	4 relay	4 relay	4 transistor	8 relay	8 relay	8 transistor
Dimensions, W x D x H (mm)	71.2x59.5x107.6	124.6x59.5x107.6	71.2x59.5x107.6			124.6x59.5x107.6		
Clock	yes	yes	no	yes	yes	no	yes	yes
Catalog Number	SR2B121JD	SR2B201JD	SR2A101BD ♦	SR2B121BD	SR2B122BD	SR2A201BD ♦	SR2B201BD	SR2B202BD
\$ Price	282.00	398.00	232.00	282.00	276.00	358.00	398.00	392.00



- ▲ Programming of smart relay in LADDER language only.
- Please consult Schneider Electric representative for list prices.

Table 23.191: Compact Smart Relays with Display, AC Power Supply

								
Supply voltage	24 Vac			100–240 Vac				
Number of inputs/outputs	12	20	10	12	20	20	20	
Number of inputs	Discrete inputs		8	12	6	8	12	12
	Including 0-10 V analog inputs		4 relay	8 relay	4 relay	4 relay	8 relay	8 relay
Dimensions, W x D x H (mm)	71.2x59.5x107.6	124.6x59.5x107.6	71.2 x 59.5 x 107.6		124.6 x 59.5 x 107.6			
Clock	yes	yes	no	yes	no	yes	yes	
Catalog Number	SR2B121B	SR2B201B	SR2A101FU ▲	SR2B121FU	SR2A201FU ▲	SR2B201FU	SR2B201FU	
\$ Price	282.00	398.00	258.00	288.00	374.00	408.00	408.00	

- ♦ Programming of smart relay in LADDER language only.

Table 23.192: Compact Smart Relays without Display and without Buttons, DC and AC Power Supply

								
Supply voltage	24 Vdc			100–240 Vac				
Number of inputs/outputs	12	20	20	10	12	20	20	
Number of inputs	Discrete inputs		6	8	12	6	8	12
	Including 0-10 V analog inputs		—	4	6	—	—	—
Number of outputs	4 relay	4 relay	8 relay	4 relay	4 relay	8 relay	8 relay	
Dimensions, W x D x H (mm)	71.2 x 59.5 x 107.6		124.6x59.5x107.6	71.2 x 59.5 x 107.6		124.6x59.5x107.6		
Clock	no	yes	yes	no	yes	yes	yes	
Catalog Number	SR2D101BD ★	SR2E121BD ■	SR2E201BD ■♦	SR2D101FU ★	SR2E121FU	SR2E201FU♦	SR2E201FU♦	
\$ Price	214.00	222.00	338.00	218.00	226.00	344.00	344.00	

- ★ Programming of smart relay in LADDER language only.
- ▼ To order a smart relay for a 24 Vac supply (no analog inputs), delete the letter D from the end of the catalog number (SR2E121B and SR2E201B).
- △ To order a smart relay without a clock, replace the letter E with the letter D (Example: SR2D201BD and SR2D201FU (these units can only be programmed in LADDER language).

Zelio® Logic 2 Smart Relays

Table 23.193: Modular Smart Relays ▲ with Display, DC and AC Power Supply



Supply voltage	12 Vdc	24 Vdc		24Vac		100-240 Vac	
Number of inputs/outputs	26	10	26	10	26	10	26
Number of inputs	Discrete inputs	16	6	16	6	16	16
	Including 0-10 V analog inputs	6	4	6	—	—	—
Number of outputs	10 relay	4 relay	10 relay	4 relay	10 relay	4 relay	10 relay
Dimensions, W x D x H (mm)	124.6x59.5x107.6	71.2x59.5x107.6	24.6x59.5x107.6	71.2x59.5x107.6	124.6x59.5x107.6	71.2x59.5x107.6	124.6x59.5x107.6
Clock	yes	yes	yes	yes	yes	yes	yes
Catalog Number	SR3B261JD	SR3B10pBD ■◆	SR3B26pBD ■◆	SR3B101B	SR3B261B	SR3B101FU	SR3B261FU
\$ Price	380.00	—	—	282.00	476.00	292.00	486.00

- ▲ The modular base can be fitted with one I/O extension module. The 24 Vdc modular base can be fitted with one communication module and/or one I/O extension module.
- Replace the p by the number 1 to order a smart relay with **relay output** or by 2 for a smart relay with **transistor output** (Example: SR3B101BD).
- ◆ Please consult local Schneider Electric representative for list prices.

Table 23.194: Extension Modules for Zelio Logic 2 SR3B***▲**

		Communication		Discrete Inputs/Outputs				Analog Inputs/Outputs	
Application		MODBUS network		—				—	
Number of inputs/outputs		—		6		10		14	
Number of inputs	Discrete inputs	—		4		6		8	
	Analog (0–10 V, 0–20 mA, PT100)	—		—		—		2■	
Number of outputs	Relay	—		2relay		4 relay		6 relay	
	Analog (0-10 V)	—		—		—		2	
Dimensions, W x D x H (mm)		35.5x59.5x107.6		35.5x59.5x107.6		72x59.5x107.6		72x59.5x107.6	
		Cat. No.	\$ Price	Cat. No.	\$ Price	Cat. No.	\$ Price	Cat. No.	\$ Price
Voltage	12 Vdc	—	—	SR3XT61JD	80.00	SR3XT101JD	100.00	SR3XT141JD	140.00
	24 Vdc	SR3MBU01BD	200.00	SR3XT61BD	106.00	SR3XT101BD	126.00	SR3XT141BD	164.00
	24 Vac	—	—	SR3XT61B	106.00	SR3XT101B	126.00	SR3XT141B	164.00
	100-240 Vac	—	—	SR3XT61FU	106.00	SR3XT101FU	126.00	SR3XT141FU	164.00

- ▲ The power supply of the extension modules is provided via the Zelio Logic 2 modular relays.
- max. 1 PT 100 input

Table 23.195: Zelio Soft Software and Memory for SR2/SR3

Multilingual Programming Software		Connecting Cables				Back-up Memory					
PCCD-ROM (Windows 98, NT, 2000, XP, ME) ▲		PC Serial to Relay		PC USB to SR2CBL01		PC USB to Relay		EEPROM (< V3.0 ZelioSoft software and firmware)		EEPROM (≥V3.0 ZelioSoft software and firmware)	
Cat. No.	\$ Price	Cat. No.	\$ Price	Cat. No.	\$ Price	Cat. No.	\$ Price	Cat. No.	\$ Price	Cat. No.	\$ Price
SR2SFT01	74.00	SR2CBL01	136.00	SR2CBL06	156.00	SR2USB01	160.00	SR2MEM01	38.00	SR2MEM02	30.00

- ▲ CD-ROM includes Zelio Soft software, application library, self-training manual, installation instructions and user's manual

Table 23.196: Communication interface for SR2/SR3

Interface, Zelio Logic 2 Alarm Software	Communication Interface ▲	Alarm Management Software	Zelio Logic GSM Modem
Supply voltage	12-24 Vdc	—	24 Vdc
Description	—	PC CD-ROM (Windows 98, NT, 2000, XP)	GSM modem
Dimensions, W x D x H	72x59.5x107.6 mm	—	—
Catalog Number	SR2COM01	SR2SFT02	SR2MOD02
\$ Price	230.00	60.00	545.00

- ▲ Modems to be supplied by user.

Approvals:



File CCN E164866 NRAQ



File Class LR217698 2252 01



Solid State Interface Modules

ABS solid state relay interface modules are for discrete digital input or output control signals exchanged in automated equipment. Features include:

- High operating rate
- 5 separate character places for marking
- Silent operation
- LED indication of the control signal state
- 35 mm DIN 3 or 32 mm DIN 1 track mountable



ABS2EA01EM

Table 23.197: Solid State Interface Input Modules

	Input Module Catalog Number					\$ Price ea.
Input Module Catalog No.	ABS2EC01EA	ABS2EC01EB	ABS2EC01EE	ABS2EA02EF	ABS2EA02EM	83.00
Dimensions (WxDxH)▲	Inches: 0.37 x 2.78 x 2.91 mm: 9.5 x 70.5 x 74					
Control Circuit Characteristics						
Rated Voltage US	5 Vdc	24 Vdc	48 Vdc	120/127 60Hz	230/240 60Hz	
Maximum Voltage	6 (TTL)	28.8 Vdc	57.6 Vdc	140 Vac	264 Vac	
Maximum Current at Us	13.6 mA	12 mA	10.5 mA	17 mA	15 mA	
Internal Protection Against Reverse Polarity	Yes	Yes	Yes	N/A	N/A	
Output Circuit Characteristics						
Rated Operational Voltage Ve	5 to 48 Vdc	5 to 48 Vdc	5 to 48 Vdc	5 to 48 Vdc	5 to 48 Vdc	
Min./Max. Voltage	2/60 Vdc	2/60 Vdc	2/60 Vdc	2/60 Vdc	2/60 Vdc	
Min./Max. Switching Current	1/50 mA	1/50 mA	1/50 mA	1/50 mA	1/50 mA	
Rated Insulation Voltage	Conforming to IEC 60947-1: 300 V Conforming to IEC 0110: 250 V group C					
Approvals	UL E164353, CSA 081630, IEC 60947-1					

Table 23.198: Solid State Interface Output Modules

	Output Module Catalog No.				\$ Price
	ABS2SC01EB	—	—	—	95.00
	—	ABS2SC02EB	—	—	95.00
	—	—	ABS2SA01MB	—	107.00
	—	—	—	ABS2SA02MB	120.00
Dimensions (W x D x H)▲	Inches: 0.69 x 2.78 x 2.91 mm: 17.5 x 70.5 x 74				
Control Circuit Characteristics					
Rated Voltage Us	24 Vdc	24 Vdc	24 Vdc	24 Vdc	
Maximum Voltage	28.8 Vdc	28.8 Vdc	28.8 Vdc	28.8 Vdc	
Maximum Current at Us	12 mA	12 mA	13.6 mA	13.6 mA	
Internal Protection against reverse polarity	Yes	Yes	Yes	Yes	
Output Circuit Characteristics					
Rated Operational Voltage Ve	5 to 48 Vdc	5 to 48 Vdc	24 to 240 Vac	24 to 240 Vac	
Maximum Voltage	57.6 Vdc	57.6 Vdc	264 Vac	264 Vac	
Internal Protection against reverse polarity	Yes	Yes	Yes	Yes	
External Protection	Against short-circuits for 1k, 1k (Ac) and <100 A (DC) Quick-blow fuse with very high breaking capacity: 3.15 A				
Rated insulation voltage	Conforming to IEC 60947-1: 300 V Conforming to VDE 0110: 250 V group C				
Approvals	UL E164353, CSA 081630, IEC 60947-1				

▲ Dimensions mounted on DIN 3 (7.5 mm high) track.

For Mounting Track, see page 24-16.

Table 23.199: How to Order

To Order Specify:	Catalog Number
• Catalog Number	ABS2EC01EA



ABS2SA01MB

Electromechanical Interface Modules

ABR electromechanical relay modules are for discrete digital input or output control signals exchanged in automated equipment. Features include:

- High contact reliability
- LED indication of the control signal state
- 5 separate character places for marking
- 35 mm DIN 3 or 32 mm DIN 1 track mountable



ABR1E411F



ABR2E112E



ABR1S111F



ABR2S102B

Table 23.200: Input Modules

Coil Voltage	Options	1 N.O. Contact	1 C.O. Contact	2 N.O. Contacts	\$ Price
		Catalog Number	Catalog Number	Catalog Number	
24 Vac/Vdc	Manual Operator and LED Indication	ABR1E118B▲	ABR1E318B▲	ABR1E418B▲	81.00
48 Vac/Vdc		ABR1E118E▲	ABR1E318E▲	ABR1E418E▲	
110–125 Vdc		ABR1E112F▲	ABR1E312F▲	ABR1E412F▲	
110–127 Vac 50/60 Hz		ABR1E111F▲	ABR1E311F▲	ABR1E411F▲	
230–240 Vac 50/60 Hz		ABR1E111M▲	ABR1E311M▲	ABR1E411M▲	
230–240 Vac 50/60 Hz	Manual Operator	ABR1E101M▲	ABR1E301M▲	—	62.00
24 Vdc	LED Indication	ABR2E112B	—	—	
48 Vdc		ABR2E112E	—	—	
120–127 Vac 60 Hz		ABR2E116F	—	—	
230–240 Vac 50/60 Hz		ABR2E111M	—	—	
24 Vdc		—	ABR2EB312B	—	90.00

▲ RoHS Compliant

Table 23.201: Output Modules

Coil Voltage	Options	1 N.O. Contact	1 C.O. Contact	2 N.O. Contacts	1 N.C. & 1 N.O. Contact	\$ Price
		Catalog Number	Catalog Number	Catalog Number	Catalog Number	
24 Vdc	Manual Operator	ABR1S102B■	ABR1S302B■	ABR1S402B■	ABR1S602B■	62.00
24 Vac/Vdc	Manual Operator and LED Indication	ABR1S118B■	ABR1S318B■	ABR1S418B■	ABR1S618B■	83.00
48 Vac/Vdc		ABR1S118E■	ABR1S318E■	ABR1S418E■	ABR1S618E■	
110–127 Vac 50/60 Hz		ABR1S111F■	ABR1S311F■	ABR1S411F■	ABR1S611F■	
24 Vdc	LED Indication	ABR2S112B	—	—	—	47.60
48 Vdc	—	—	ABR2SB312B	—	—	95.00
24 Vdc	—	ABR2S102B	—	—	—	30.90

■ RoHS Compliant

Table 23.202: Coil Data

Relay	Coil Voltage Ue	ABR1E						ABR2E				ABR2EB	ABR1S				ABR2S	ABR2SB
		24 Vac/Vdc	48 Vac/Vdc	127 Vdc	127 Vac	240 Vac	24 Vdc	48 Vdc	127 Vac	240 Vac	24 Vdc	24 Vdc	24 Vdc	48 Vac/Vdc	127 Vac	24	24	24
Maximum Voltage	V	30	53	137	140	255	28.8	56	140	264	28.8	30	30	53	140	28.8	28.8	28.8
Pick-up Voltage	V	17	38	97	93	195	16.9	37.3	97	186	16.9	17	17	38	83	16.9	16.9	16.9
Minimum Sealed Current	mA	5.2	5.4	1.5	2.4	2	2	2	2.5	2.5	2	6.6	6.2	5.4	2.4	2	2	2
Maximum Sealed Current	mA	62	36	15	8	7	19.5	11	16	15	29	62	62	36	8	28	17	29

Table 23.203: Contact Ratings

Relay		ABR1E	ABR2E	ABR2EB	ABR1S	ABR2S	ABR2SB
Rated Voltage Ue	Vac	250	115	48	250	230	48
Rated Voltage Ue	Vdc	125	100	48	125	120	48
Thermal Current Ith	A	2	1	0.05	5	5	0.05
Break Rating (AC14)	A	1	0.5	1	1	1	—
Break Rating (DC13)	A	1	1	1	1	1.5	—

Table 23.204: Dimensions

Modules	Approximate Dimensions (WxDxH)♦	
	In.	mm
ABR1E, ABR2EB, ABR2SB	0.69 x 2.91 x 2.78	17.5 x 74 x 70.5
ABR2E	0.37 x 2.91 x 2.78	9.5 x 74 x 70.5
ABR2S1	0.47 x 2.91 x 2.78	12 x 74 x 70.5

♦ Dimensions mounted on DIN 3 track (7.5 mm high).

Table 23.205: Approvals

ABR1E, ABR2E	UL E164353, CSA 081630, IEC 60947-1
ABR1S, ABR2S	UL E164353, CSA 081630, IEC 60947-1

ABR1 relays are RoHS compliant as of date code 0610.

For Mounting Track, see page 24-16

New! **Schneider Electric Solid State Relays**

Solid state relays do not have any moving parts to wear out. Combined with vibration resistance, arc-less switching and the lack of acoustical noise, you have the ideal product for switching applications that demand reliable execution. For added reliability the Zelio[®] SSRP and SSRD solid state relays utilize Direct Copper Bonding (DCB) technology to decrease internal temperatures and improve the overall quality of the product.

Key features include:

- Input voltage range 3 to 32 Vdc, 90 to 280 Vac
- Breaking capacities up to 125 A
- Zero voltage turn on, low EMI / RFI
- No moving parts
- Shock and Vibration resistant
- No acoustical noise
- Fast response
- Arc-less switching
- Long life (>10⁹ operations)



SSRPCDS25A1



SSRDCDS10A1



SSRDCDS45A1



SSRAH1



SSRAT1

Table 23.206: Solid State Relays

Switching	Voltage Range		Load Current Range	Catalog Number	\$ Price ea.
	Input	Output			
	V	V	A		
Panel Mounted					
SCR Output Zero voltage switching	3***32 DC	24***280 AC	10	SSRPCDS10A1	48.20
			25	SSRPCDS25A1	49.80
			50	SSRPCDS50A1	70.00
	4***32 DC	48***530 AC	75	SSRPCDS75A2	119.00
			90	SSRPCDS90A3	135.00
			125	SSRPCDS125A3	171.00
	90***280 AC	24***280 AC	10	SSRPP8S10A1	51.00
			25	SSRPP8S25A1	54.00
			50	SSRPP8S50A1	63.00
			75	SSRPP8S75A2	135.00
			90	SSRPP8S90A3	140.00
			125	SSRPP8S125A3	159.00
MOSFET Output Instant switching	3.5***32 DC	0***100 DC	12	SSRPCDM12D5	79.00
			25	SSRPCDM25D5	98.00
			40	SSRPCDM40D5	135.00
DIN Rail Mounted					
SCR Output Zero voltage switching	4***32 DC	24***280 AC	10	SSRDCDS10A1	69.00
			20	SSRDCDS20A1	96.00
			30	SSRDCDS30A1	101.00
	3***32 DC	24***280 AC	45	SSRDCDS45A1	118.00
			10	SSRDP8S10A1	72.00
			20	SSRDP8S20A1	83.00
90***280 AC	24***280 AC	30	SSRDP8S30A1	93.00	
		45	SSRDP8S45A1	126.00	

Table 23.207: Accessories For Panel Mount Solid State Relays

Description	For Use With Relays	Load Current Range	Catalog Number	\$ Price ea.
Heat Sink	SSRPP8S***	up to 50 A	SSRAH1	30.60
	SSRPCDS***			
Pre-Cut Thermal Transfer Pad (sold in pack of 10)	SSRPP8S***	up to 125 A	SSRAT1	2.76
	SSRPCDS***			

New! Zelio® Temperature Controllers

The new Zelio REG temperature controllers offer seamless interfacing with solid state relays, electromechanical relays, PLCs, variable speed drives and HMI displays make them a key component to controlling the temperature in your process.

Offer includes 3 versions:

- A 24x48 (1/32 DIN) cost effective solution for basic temperature control needs.
- A 48x48 mm (1/16 DIN) balanced version for optimal price and functionality.
- A 96x48 mm (1/8 DIN) full-featured version for complete performance and function.

Key features include:

- Modbus communication for easy data exchange with other automation products
- Simple parameter settings
- IP66 certification enables dust resistance
- Flash memory (saves configurations)
- Compatible with a wide range of sensors
- Advanced Functions (standard): PID, fuzzy logic, auto-tuning, soft start
- Optimized programming
 - Common software for all products in the temperature relay range (freely downloadable from schneider-electric.com).
 - A single cable enables connection to both a computer and PLCs.
 - Simple adjustment of parameters.
 - Saving of configurations.



REG24PTP1RHU



REG48PUN1RHU



REG96PUN1RHU

Table 23.208: Zelio Temperature Controllers

Input Type	Supply Voltage	Number and Type of Outputs	Alarms	Communication on Modbus	Catalog Number	\$ Price
28 x 48 Size — 1/32 DIN Standard						
Thermocouple PT100 Probe	100/240 Vac	1 electromechanical relay	No	Yes	REG24PTP1RHU	248.
		1 electromechanical relay 1 solid state relay	1	Yes	REG24PTP1ARHU	221.
	24 Vac/Vdc	1 solid state relay	No	Yes	REG24PTP1LHU	257.
		1 solid state relay	1	No	REG24PTP1ALHU	228.
		1 analog interface (4–20 mA)	No	Yes	REG24PTP1JHU	260.
Voltage/current	100/240 Vac	1 electromechanical relay	No	Yes	REG24PUJ1RHU	248.
		1 solid state relay	No	Yes	REG24PUJ1LLU	257.
	24 Vac/Vdc	1 electromechanical relay	No	Yes	REG24PUJ1RLU	248.
		1 solid state relay	No	Yes	REG24PUJ1LLU	257.
48 x 48 Size — 1/16 DIN Standard						
Universal	100/240 Vac	1 electromechanical relay	2	Yes No	REG48PUN1RHU REG48PUN1RHU	300. 269.
		2 electromechanical relays	2	Yes	REG48PUN2RHU	347.
		1 solid state relay	2	Yes No	REG48PUN1LHU REG48PUN1LHU	306. 278.
		1 solid state relay + 1 electromechanical relay	2	Yes	REG48PUN2LRHU	350.
		1 analog interface (4–20 mA)	2	Yes	REG48PUN1JHU	309.
	1 solid state relay + 1 analog interface (4–20 mA)	2	Yes	REG48PUN2JHU	354.	
	24 Vac/Vdc	1 electromechanical relay	2	Yes	REG48PUN1RLU	300.
		2 electromechanical relays	2	Yes	REG48PUN2RLU	347.
		1 solid state relay	2	Yes	REG48PUN1LLU	306.
		1 solid state relay + 1 electromechanical relay	2	Yes	REG48PUN2RLU	350.
1 analog interface (4–20 mA)		2	Yes	REG48PUN1JLU	309.	
1 solid state relay + 1 analog interface (4–20 mA)	2	Yes	REG48PUN2JLU	354.		
98 x 48 Size — 1/8 DIN Standard						
Universal	100/240 Vac	1 electromechanical relay	3	Yes No	REG96PUN1RHU REG96PUN1RHU	399. 369.
		2 electromechanical relays	3	Yes	REG96PUN2RHU	453.
		1 solid state relay	3	Yes No	REG96PUN1LHU REG96PUN1LHU	408. 377.
		1 solid state relay + 1 electromechanical relay	3	Yes	REG96PUN2LRHU	455.
		1 analog interface (4–20 mA)	3	Yes	REG96PUN1JHU	410.
	1 solid state relay + 1 analog interface (4–20 mA)	3	Yes	REG96PUN2JHU	458.	
	24 Vac/Vdc	1 electromechanical relay	3	Yes	REG96PUN1RLU	399.
		2 electromechanical relays	3	Yes	REG96PUN2RLU	453.
		1 solid state relay	3	Yes	REG96PUN1LLU	408.
		1 solid state relay + 1 electromechanical relay	3	Yes	REG96PUN2RLU	455.
1 analog interface (4–20 mA)		3	Yes	REG96PUN1JLU	410.	
1 solid state relay + 1 analog interface (4–20 mA)	3	Yes	REG96PUN2JLU	458.		

Table 23.209: Temperature Controller Accessories

Description	For Use With Relays	Sold In Lots Of	Catalog Number	\$ Price
Bracket for mounting on DIN rail	24 x 48 mm (1/32 DIN)	4	REG24PSOC	26.
Terminal block cover	48 x 48 mm (1/16 DIN)	2	REG48PCOV	36.
	96 x 48 mm (1/8 DIN)	2	REG96COV	44.

Zelio® Plug-In Relays

Zelio RSL plug-in relays save valuable panel space with a 6 mm width and have a 6 Amp general purpose load rating. Some of the features include:

- Pre-assembled option: relay and socket are combined into one catalog number.
- Universal AC/DC sockets have built-in protection from transients and reverse polarity voltages (see catalog 8501CT0901 for more detailed information).



RSL 1PV** RSL 1PR**



RSL 1AB**



RSL ZVA* RSL ZRA*



RSL Z2



RSL Z3

Table 23.210: Zelio RSL Slim Interface: Pre-assembled Relay + Socket (sold in lots of 10)

Socket Supply Voltage (Vac/Vdc)	Relay Coil Voltage (Vdc)	Socket Type			
		Screw Connector		Spring Terminal	
		Catalog Number▲	\$ Price ea.	Catalog Number▲	\$ Price ea.
12	12	RSL1PVJU	14.30	RSL1PRJU	14.30
24	24	RSL1PVBU	17.30	RSL1PRBU	18.70
48	48	RSL1PVEU	17.70	RSL1PREU	19.10
110	60	RSL1PVFU	17.70	RSL1PRFU	19.10
230	60	RSL1PVPU	17.70	RSL1PRPU	19.10

▲ Relays are mounted on sockets equipped with LED and protection circuit.

Table 23.211: Zelio RSL Slim Interface: Relay Only (sold in lots of 10)

Relay Coil Voltage (Vdc)	Catalog Number	\$ Price ea.
12	RSL1AB4JD	7.40
24	RSL1AB4BD	9.10
48	RSL1AB4ED	9.40
60	RSL1AB4ND	9.40

Table 23.212: Zelio RSL Slim Interface: Socket Only (sold in lots of 10)

Socket Supply Voltage (Vac/Vdc)	For use with relays:	Socket Type			
		Screw Connector		Spring Terminal	
		Catalog Number	\$ Price ea.	Catalog Number	\$ Price ea.
12	RSL1AB4JD	RSLZVA1	8.50	RSLZRA1	9.90
24	RSL1AB4BD			RSLZRA1	
48	RSL1AB4ED	RSLZVA2	8.50	RSLZRA2	9.90
60	RSL1AB4ND			RSLZRA2	
110	RSL1AB4ND	RSLZVA3	8.80	RSLZRA3	10.20
230	RSL1AB4ND	RSLZVA4	8.80	RSLZRA4	10.20

Table 23.213: Socket Accessories

Description	Compatibility	Catalog Number	\$ Price ea.
ID tags (2 sheets of 64)	With all sockets	RSLZ5	5.50
Bus jumper (10 x 20-pole jumpers)	With all sockets	RSLZ2	4.50
Butterfly isolator (10 isolators)	With all sockets	RSLZ3	4.40

Approvals for RSL relays:



Approvals for RSLZ sockets:



