

UL Listed Enclosed Power Distribution Blocks

Specifications:

Electrical

- 600 Volts AC/DC (UL 1953)
- 1000 Volts (IEC)
- Up to 200 Amps
- Wire Range #2 to #14
- Flexible Stranded Wire Compliant

Mechanical

- Base, Gray Thermoplastic, 125°C (257°F) (UL RTI)
- Flammability, UL 94 V-0
- Mounting: DIN or panel mount

Standards













- UL Listed File No. QPQS.E309401 (UL 1953)
- CSA Certified File No. LR19766 (CSA C22-2 No. 158)
- Ⓢ (Component IEC 60947-7-1)
- IEC 60529, IP-20
- RoHS Compliant



Shown left to right: EPBAD42, EPBAD45, EPBAD21, EPBAD24

Accessories (consult Cust. Service)

- White Markers to Identify Circuits
- DIN Rail for Mounting Option (MN35-2)
- End Piece for DIN Rail (MSK35)

Catalog #	Amps	LINE SIDE			LOAD SIDE			SCCR, RMS SYM Amps 600 Volt Max
		Wire Range AWG/kcmil	Openings Per Pole	Connector Configuration	Wire Range AWG/kcmil	Openings Per Pole	Connector Configuration	
EPBAD21	115	#2 - #14 AWG 35 - 2.5 mm ²	1		#2 - #14 AWG 35 - 2.5 mm ²	1		100,000
EPBAD24	115	#2 - #14 AWG 35 - 2.5 mm ²	1		#10 - #14 AWG 6 - 2.5 mm ²	4		65,000
EPBAD42	200	3/0 - #14 AWG	1		3/0 - #14 AWG	1		100,000
EPBAP42		70 - 2.5 mm ²			70 - 2.5 mm ²			
EPBCD42	200	3/0 - #14 AWG	1		3/0 - #14 AWG	1		100,000
EPBCP42		70 - 2.5 mm ²			70 - 2.5 mm ²			
EPBAD45	200	3/0 - #14 AWG	1		#2 - #14 AWG	4		65,000 / 100,000
EPBAP45		70 - 2.5 mm ²			35 - 2.5 mm ²			
EPBCD45	200	3/0 - #14 AWG	1		#2 - #14 AWG	4		65,000 / 100,000
EPBCP45		70 - 2.5 mm ²			35 - 2.5 mm ²			

Ordering Code:

See page 41 for dimensional information.

EPB

A

D

42

Connector Material:
A - Aluminum rated copper
or aluminum wire
C - Copper CU wire only

Mounting:
D - Mount on 35 mm DIN rail
P - Flat panel

(21/24 are DIN and panel mountable)

21 - (1) #2 to (1) #2
24 - (1) #2 to (4) #10
42 - (1) 3/0 to (1) 3/0
45 - (1) 3/0 to (4) #2

UL Listed Enclosed Power Distribution Blocks (cont.)

EPBAD21/EPBAD24

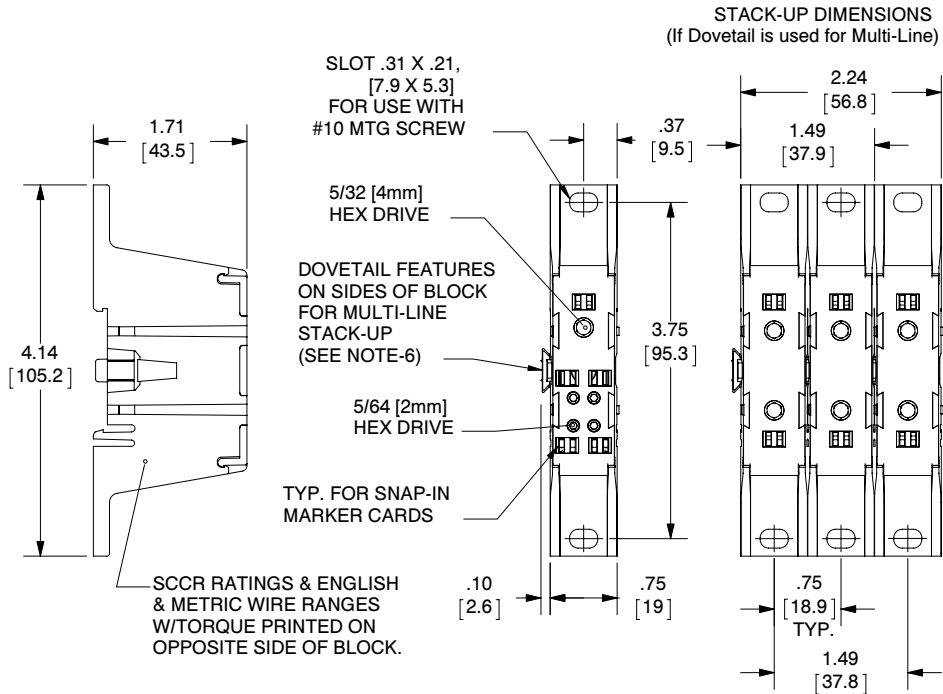

EPBXX42/EPBXX45

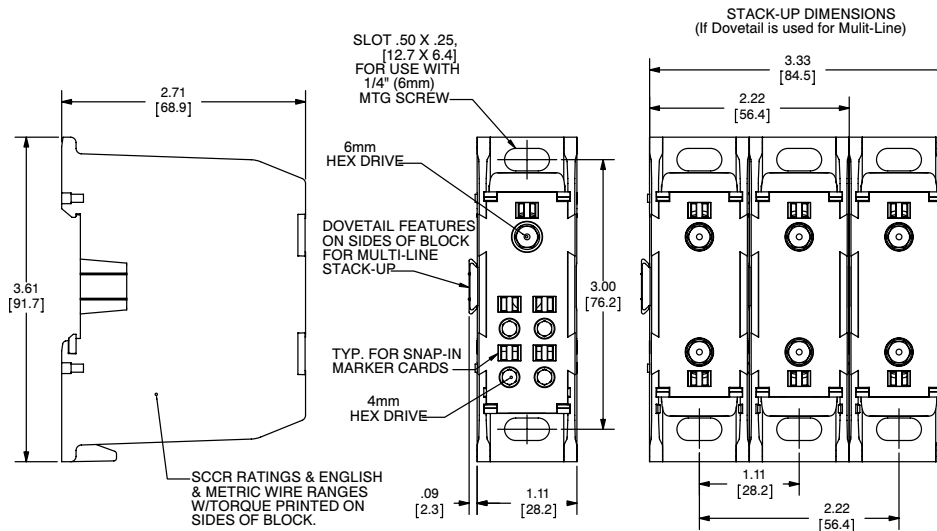

For electronic drawings or 2D/3D CAD data, submit request at www.marathonsp.com/drawings.html

Datasheets available at marathonsp.com