

SCHOTTKY RECTIFIER

40 Amp

$$I_{F(AV)} = 40\text{Amp}$$

$$V_R = 60\text{V}$$

Major Ratings and Characteristics

Characteristics	Values	Units
$I_{F(AV)}$ Rectangular waveform	40	A
V_{RRM}	60	V
I_{FSM} @tp = 5 μ s sine	1020	A
V_F @20 Apk, $T_J=125^\circ\text{C}$ (per leg)	0.62	V
T_J	-55 to 150	$^\circ\text{C}$

Description/ Features

The MBR4060WTPbF center tap Schottky rectifier has been optimized for very low forward voltage drop, with moderate leakage. The proprietary barrier technology allows for reliable operation up to 150° C junction temperature. Typical applications are in switching power supplies, converters, free-wheeling diodes, and reverse battery protection.

- 150° C T_J operation
- Center tap TO-247 package
- High purity, high temperature epoxy encapsulation for enhanced mechanical strength and moisture resistance
- Very low forward voltage drop
- High frequency operation
- Guard ring for enhanced ruggedness and long term reliability
- Lead-Free ("PbF" suffix)

Case Styles

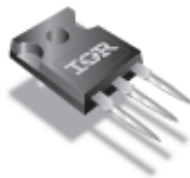

TO-247

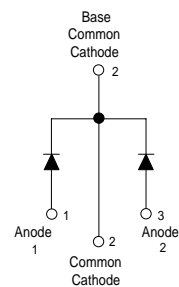

Voltage Ratings

Part number	MBR4060WTPbF
V_R Max. DC Reverse Voltage (V)	60
V_{RWM} Max. Working Peak Reverse Voltage (V)	

Absolute Maximum Ratings

Parameters	Values	Units	Conditions
$I_{F(AV)}$ Max. Average Forward Current (Per Device) (Per Leg)	40 20	A	@ $T_C = 108^\circ\text{C}$, 50% duty cycle, rectangular waveform
I_{FSM} Max. Peak One Cycle Non-Repetitive Surge Current (Per Leg) See fig.7	1020 265	A	5 μs Sine or 3 μs Rect. pulse 10ms Sine or 6ms Rect. pulse Following any rated load condition and with rated V_{RRM} applied
E_{AS} Non-Repetitive Avalanche Energy (Per Leg)	13	mJ	$T_J = 25^\circ\text{C}$, $I_{AS} = 1.5$ Amps, $L = 11.5$ mH
I_{AR} Repetitive Avalanche Current (Per Leg)	1.5	A	Current decaying linearly to zero in 1 μsec Frequency limited by T_J max. $V_A = 1.5 \times V_R$ typical

Electrical Specifications

Parameters	Values	Units	Conditions
V_{FM} Max. Forward Voltage Drop (1)	0.72 0.62	V	@ 20A $T_J = 25^\circ\text{C}$ @ 20A $T_J = 125^\circ\text{C}$
I_{RM} Max. Instantaneous Reverse Current	1.0 100	mA	$T_J = 25^\circ\text{C}$ $T_J = 125^\circ\text{C}$ Rated DC voltage
C_T Max. Junction Capacitance	720	pF	$V_R = 5V_{DC}$ (test signal range 100Khz to 1Mhz) 25°C
L_S Typical Series Inductance	7.5	nH	Measured from top of terminal to mounting plane
dv/dt Max. Voltage Rate of Change (Rated V_R)	10000	V/ μs	

(1) Pulse Width < 300 μs , Duty Cycle <2%

Thermal-Mechanical Specifications

Parameters	Values	Units	Conditions
T_J Max. Junction Temperature Range	-55 to 150	$^\circ\text{C}$	
T_{stg} Max. Storage Temperature Range	-55 to 150	$^\circ\text{C}$	
R_{thJC} Max. Thermal Resistance Junction to Case (Per Package)	2.20	$^\circ\text{C}/\text{W}$	DC operation
R_{thCS} Typical Thermal Resistance Case to Heatsink	1.10	$^\circ\text{C}/\text{W}$	Mounting surface, smooth and greased
wt Approximate Weight	6 (0.21)	g (oz.)	
T Mounting Torque	Min. 6 (5) Max. 12 (10)	Kg-cm (lbf-in)	
Case Style	TO-247AC (TO-3P)		JEDEC
Device Marking	MBR4060WT		

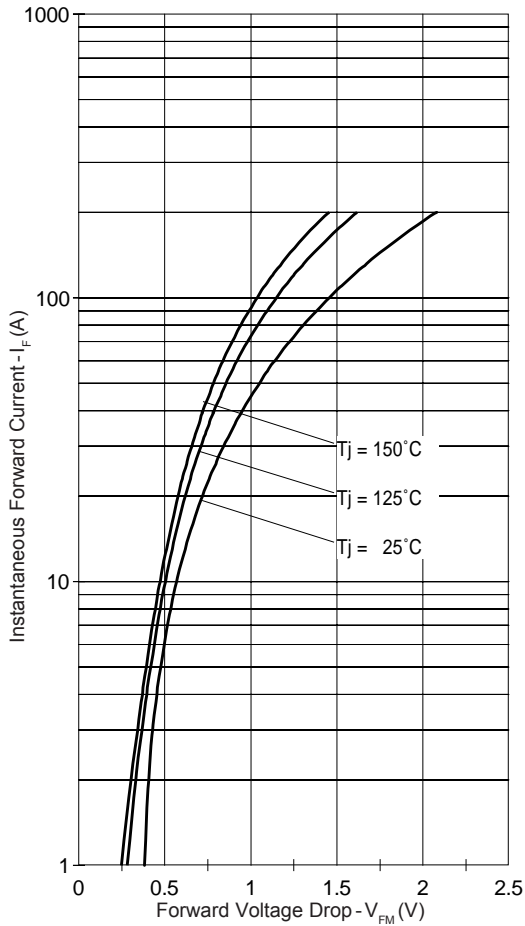

Fig.1 - Max. Forward Voltage Drop Characteristics

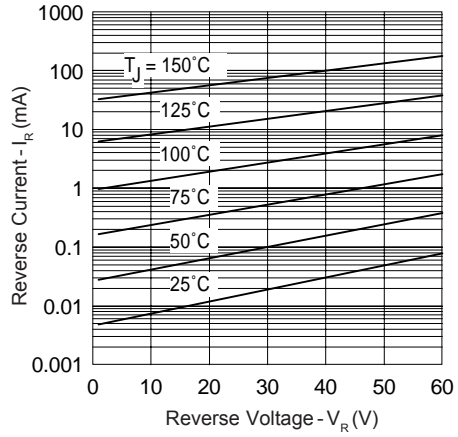

Fig.2 - Typical Values Of Reverse Current Vs. Reverse Voltage

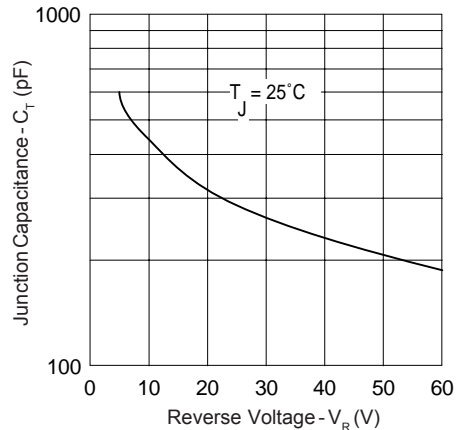

Fig.3 - Typical Junction Capacitance Vs. Reverse Voltage

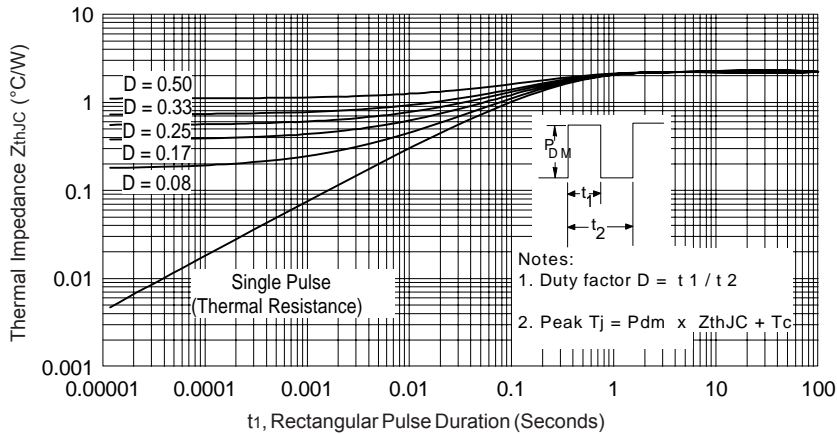

Fig.4 - Max. Thermal Impedance Z_{thJC} Characteristics

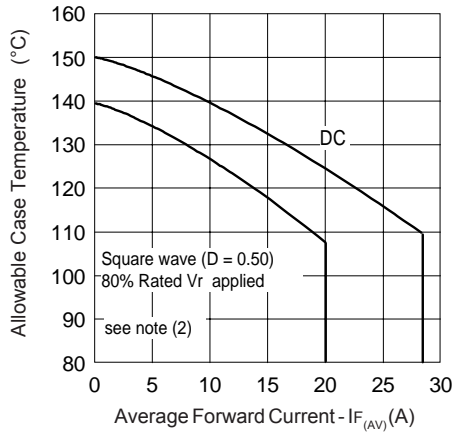

Fig. 5 - Max. Allowable Case Temperature Vs. Average Forward Current

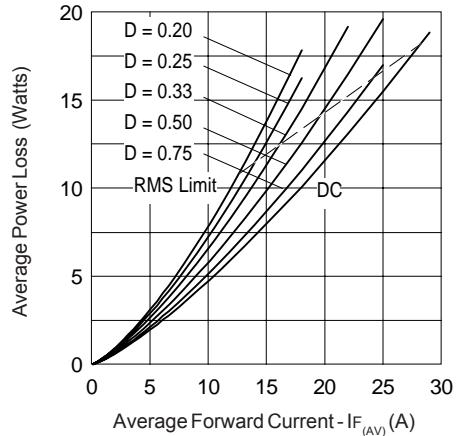

Fig. 6 - Forward Power Loss Characteristics

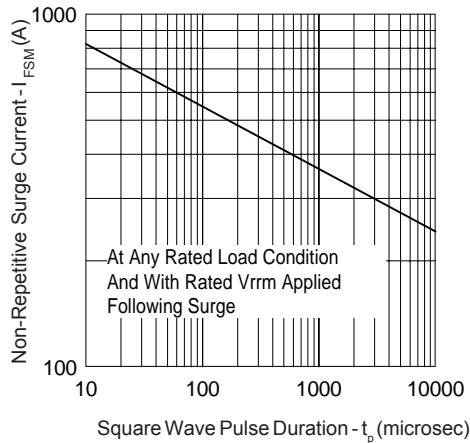

Fig. 7 - Max. Non-Repetitive Surge Current

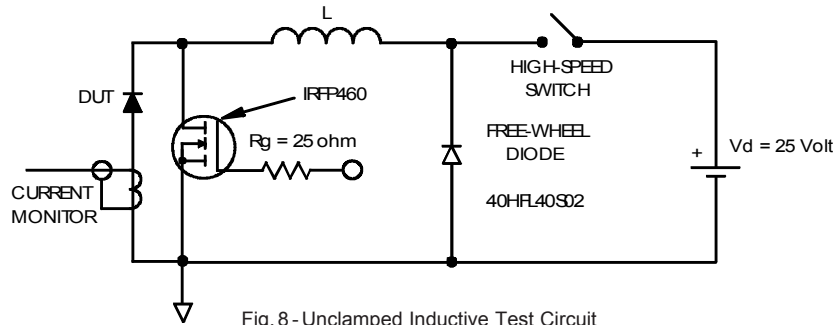

Fig. 8 - Unclamped Inductive Test Circuit

(2) Formula used: $T_C = T_J - (Pd + Pd_{REV}) \times R_{thJC}$

$Pd = \text{Forward Power Loss} = I_{F(AV)} \times V_{FM} @ (I_{F(AV)} / D)$ (see Fig. 6);

$Pd_{REV} = \text{Inverse Power Loss} = V_{R1} \times I_R (1 - D); I_R @ V_{R1} = 80\% \text{ rated } V_R$

Outline Table

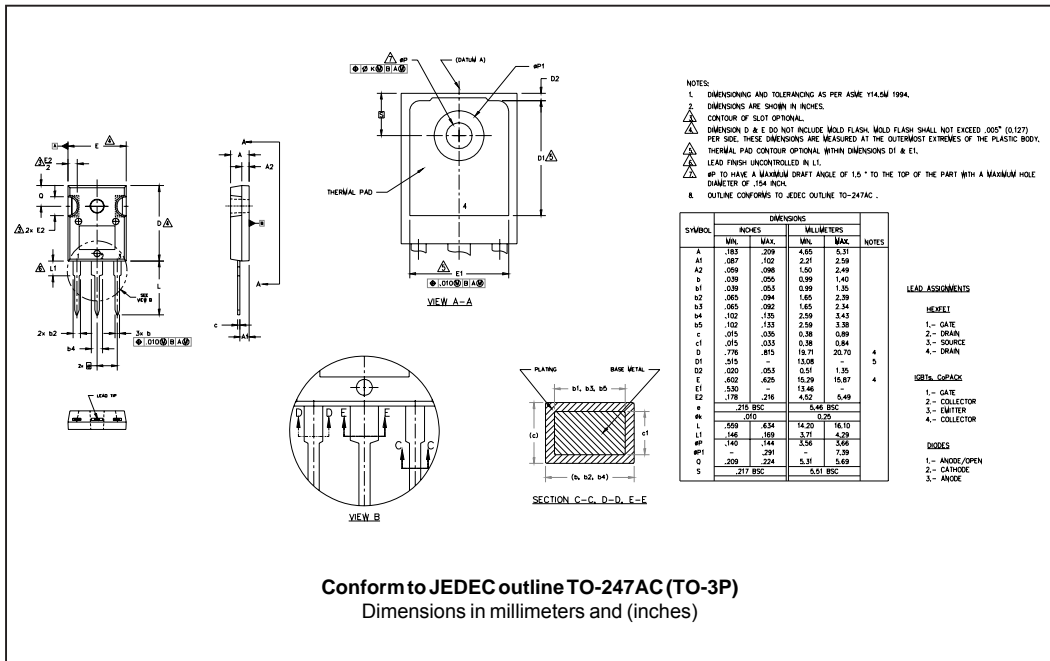

Marking Information

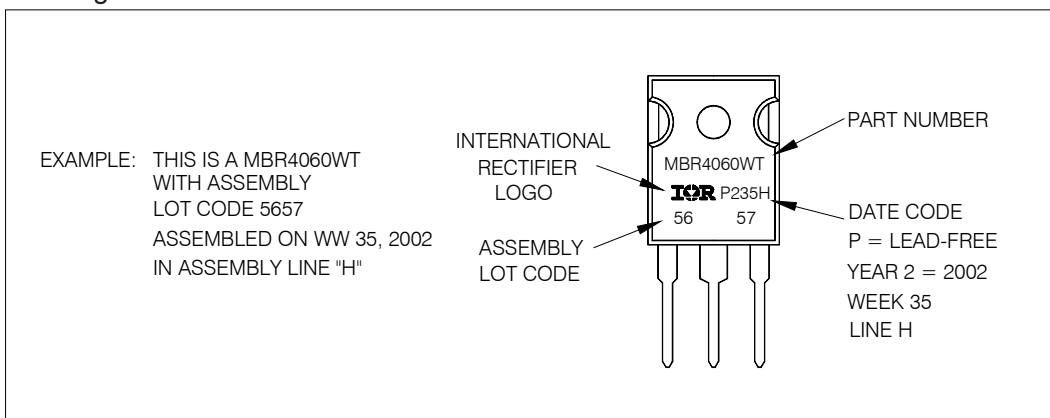

Ordering Information Table

Device Code	
MBR	40
60	WT
PbF	
①	②
③	④
⑤	

<table border="0"> <tr><td style="background-color: black; color: white; padding: 2px;">1</td><td style="padding: 2px;">-</td><td style="padding: 2px;">Schottky MBR Series</td></tr> <tr><td style="background-color: black; color: white; padding: 2px;">2</td><td style="padding: 2px;">-</td><td style="padding: 2px;">Current Rating (40 = 40A)</td></tr> <tr><td style="background-color: black; color: white; padding: 2px;">3</td><td style="padding: 2px;">-</td><td style="padding: 2px;">Voltage Rating (60 = 60V)</td></tr> <tr><td style="background-color: black; color: white; padding: 2px;">4</td><td style="padding: 2px;">-</td><td style="padding: 2px;">Circuit Configuration :</td></tr> <tr><td></td><td style="padding: 2px;"></td><td style="padding: 2px;">Center Tap (Dual) TO-247</td></tr> <tr><td style="background-color: black; color: white; padding: 2px;">5</td><td style="padding: 2px;">-</td><td style="padding: 2px;">• none = Standard Production</td></tr> <tr><td></td><td style="padding: 2px;"></td><td style="padding: 2px;">• PbF = Lead-Free</td></tr> </table>	1	-	Schottky MBR Series	2	-	Current Rating (40 = 40A)	3	-	Voltage Rating (60 = 60V)	4	-	Circuit Configuration :			Center Tap (Dual) TO-247	5	-	• none = Standard Production			• PbF = Lead-Free
1	-	Schottky MBR Series																			
2	-	Current Rating (40 = 40A)																			
3	-	Voltage Rating (60 = 60V)																			
4	-	Circuit Configuration :																			
		Center Tap (Dual) TO-247																			
5	-	• none = Standard Production																			
		• PbF = Lead-Free																			

Data and specifications subject to change without notice.
 This product has been designed and qualified for Industrial Level and Lead-Free.
 Qualification Standards can be found on IR's Web site.