

TECHNICAL CHARACTERISTICS

MATERIAL  
 INSULATOR: NYLON 6T  
 FLAMABILITY RATING: UL94-V0  
 COLOR: BEIGE  
 CONTACT MATERIAL: COPPER ALLOYS  
 CONTACT TYPE: STAMPED  
 CONTACT PLATING: TIN  
 QUALITY CLASS: 25 MATING CYCLES  
 PITCH: 1.50MM

ENVIRONMENTAL  
 OPERATING TEMPERATURE: -25 UP TO 85°C  
 COMPLIANCE: LEAD FREE AND ROHS

ELECTRICAL  
 CURRENT RATING: 1A MAX  
 WORKING VOLTAGE: 50V AC  
 INSULATOR RESISTANCE: >100 MOHM  
 DIELECTRIC WITHSTANDING VOLTAGE: 500V AC/MN  
 CONTACT RESISTANCE: 20 mOHM MAX

STANDARD  
 CERTIFIED: E323964 / MODEL NUMBER 648-R

SOLDERING:  
 REFLOW PROCESS ONLY

PACKAGING  
 TAPE & REEL

DIMENSION

NB PIN	A	B	NB PIN	A	B
2	1.50	6.00	8	10.50	15.00
3	3.00	7.50	9	12.00	16.50
4	4.50	9.00	10	13.50	18.00
5	6.00	10.50	11	15.00	19.50
6	7.50	12.00	12	16.50	21.00
7	9.00	13.50	13	18.00	22.50

PCB LAYOUT - COMPONENT VIEW

RoHS Compliant			
G			
F			
E			
D			
C	24-NOV-10	COPLANARITY	GG
B	17-NOV-09	STANDARD	JP
A	23-JUN-08	PDF	CH
REV	DATE	FILE	BY

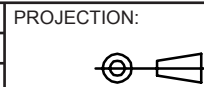

GENERAL TOLERANCE  
 .X = +/- 0.2  
 .XX = +/- 0.15



APPROVAL: RJ

UNIT: MM  
 SCALE:  
 SHEET: 1/2  
 DRAW: ANDY

DESCRIPTION: 1.50 SMT MALE HORIZONTAL SHROUDED HEADER  
 WERI PART NO: 648 1xx 131 822

SIZE  
**A4**

1

2

3

4

5

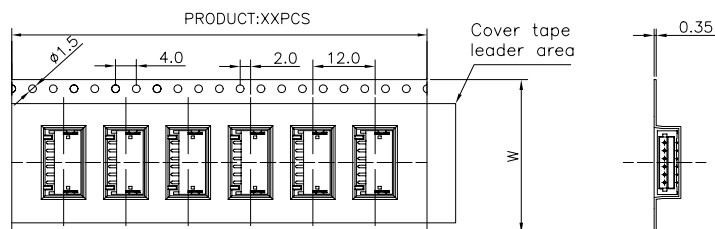
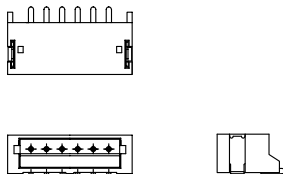

For Reel width (dimension W)16,24mm ,Single row hole

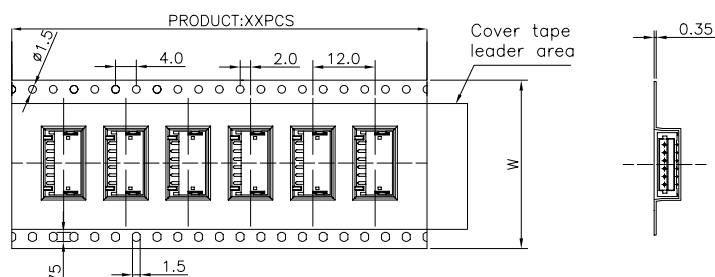

For Reel width (dimension W)32,44,56,72mm ,Double rows hole

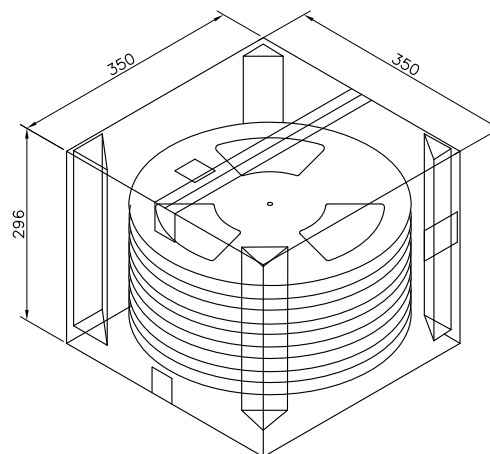
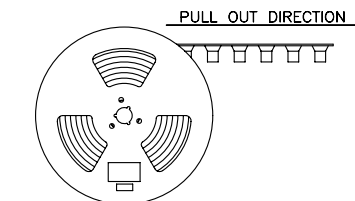
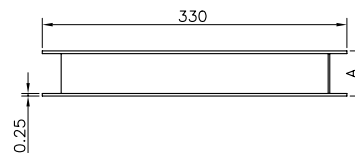

Note:

- 1.All dimensions meet EIA-481-3 requirements.
- 2.Material : White Conductive Polystyrene Alloy  
100% recyclable.
- 3.Thickness :  $0.35 \pm 0.05$ mm
- 4.Component load per 13" reel :1000 pcs.
- 5.CARTON SIZE:350\*350\*296(MM)

Pin No	W	A	PCS/R	R/CTN	Q'TY
02	16	21	1000	12	1000*12
03	16	21	1000	12	1000*12
04	24	29	1000	9	1000*9
05	24	29	1000	9	1000*9
06	24	29	1000	9	1000*9
07	24	29	1000	9	1000*9
08	32	37	1000	7	1000*7
09	32	37	1000	7	1000*7
10	32	37	1000	7	1000*7
11	44	49	1000	5	1000*5
12	44	49	1000	5	1000*5
13	44	49	1000	5	1000*5

RoHS Compliant

PROJECTION:

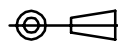

GENERAL TOLERANCE

.X =  $\pm 0.2$

.XX =  $\pm 0.15$



APPROVAL: RJ

UNIT: MM

DESCRIPTION: 1.50 SMT MALE HORIZONTAL SHROUDED HEADER

SIZE

SCALE:

WERI PART NO: 6481 xx 131822

**A4**

SHEET: 2/2

DRAW: WGL

23-JUN-08

PDF

CH

DATE

FILE

BY