

Heavy-Duty Plug-In Switches

Contents

Overview 1
 Model Selection, Assembled Switches 2
 Model Selection, Operating Heads 5
 Model Selection, Switch Bodies 6
 Model Selection, Receptacles 7
 Model Selection, Accessories 8
 Specifications 10
 Dimensions 11

E50 Modular Plug-In Limit Switch Components are the industry standard with versatility of design and high reliability for low maintenance, installation and inventory costs. Standard Viton gaskets, seals and boots and a zinc die cast enclosure provide exceptional chemical resistance to the common coolants, cleansing agents, and hydraulic fluids found in machine tool, automotive, waste water treatment and other heavy-duty industrial applications. Mounting dimensions accommodate both U.S. and DIN standards for easy retrofit installations. Super bright 24 – 120V AC/DC LED indicating light versions simplify setup and troubleshooting operations.

Approvals

- UL Listed
- CSA Certified
- IEC.947.5.1
- TUV — E9271605E02

CE (where shown)

For the most current information on this product, visit our web site at: www.sensingsolutions.com

Modular Limit Switches Provide Extremely Easy Installation, High Reliability, and Low Maintenance and Inventory Costs

Available as Assembled Switches or Components

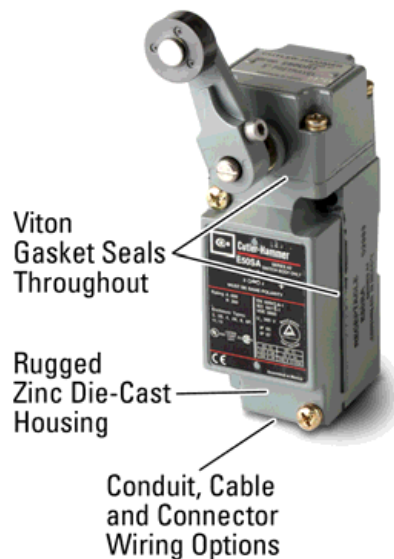

Dozens of Operators to Perfectly Fit Your Application



Rotary, Top and Side Push, Wobble and Specialty Operating Heads



Single or Double Pole Switch Bodies with Optional Indicating Lights









A Variety of Receptacles Meet Your Wiring Needs

Product Features

- Modular, plug-in components (head, body and receptacle) provide application flexibility, reduced inventory and less downtime
- Manufactured to take the physical and environmental abuse (including cutting fluids and chemicals) of harsh industrial environments
- Chemical resistant Viton gaskets, seals and boots are standard, and so are captive, posi-drive screws
- The switches have terminal identification on the nameplate for a visual wiring checkout without guesswork. Heads and switch bodies can be replaced without rewiring
- E50 devices can be ordered in separate components or as complete assembled switches
- 600V rating, ridge-topped contacts and wiping action assure continuity even to logic level circuits
- Keyed, four direction head positioning
- Standard 5° pre-travel and 90° total travel
- 24 – 120V AC/DC LED and 120V AC neon indicating lights available
- Rotary heads are field convertible CW, CCW, or both, without special tools
- Epoxy filled, pin connector or pigtail pin connector receptacles available

For Customer Service in the U.S. call **1-800-356-1243**,
 in Canada call **1-800-268-3578**.
 For Application Assistance in the U.S. and Canada
 call **1-800-426-9184**.

Model Selection — Assembled Switches — Standard

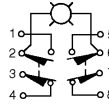
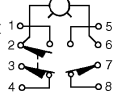
Assembled Switch	Single Pole (5 Terminal Receptacle)			Double Pole (9 Terminal Receptacle)					
	Indicating Light:	None	LED (24 – 120V AC/DC)	Neon (120V AC)	None	LED (24 – 120V AC/DC)	Neon (120V AC)	LED (24 – 120V AC/DC)	Neon (120V AC)
	Switch Body:	E50SA 1N.O.-1N.C.	E50SAL 1N.O.-1N.C.	E50SAN 1N.O.-1N.C.	E50SB 2N.O.-2N.C.	E50SBL 2N.O.-2N.C.	E50SBN 2N.O.-2N.C.	E50SCL 1N.O.-2N.C.	E50SCN 1N.O.-2N.C.
	Receptacle: ①	E50RA	E50RA	E50RA	E50RB	E50RB	E50RB	E50RB	E50RB
Operating Head Type ②		Catalog Number for Assembled Switches							
Side Rotary (requires an operating lever, see PG.05C.04.T.E) 	Standard Spring Return — E50DR1 ③	E50AR1 ☺☺	E50ALR1	E50ANR1	E50BR1	E50BLR1	E50BNR1	—	E50CNR1
	Low Force Spring Return — E50DL1 ③	E50AL1 ☺☺	E50ALL1	E50ANL1	E50BL1	E50BLL1	E50BNL1	E50CLL1	E50CNL1
	Maintained Two-Position — E50DM1	E50AM1 ☺☺	E50ALM1	E50ANM1	E50BM1	E50BLM1	E50BNM1	E50CLM1	E50CNM1
Side Pushbutton, Spring Return — E50DS1 		E50AS1 ☺☺	E50ALS1	E50ANS1	E50BS1	E50BLS1	E50BNS1	E50CLS1	E50CNS1
Side Pushbutton, Adjustable Spring Return — E50DS2 		E50AS2 ☺☺	E50ALS2	E50ANS2	E50BS2	E50BLS2	E50BNS2	E50CLS2	E50CNS2
Side Push Roller, Spring Return — E50DS3 ④ 		E50AS3 ☺☺	E50ALS3	E50ANS3	E50BS3	E50BLS3	E50BNS3	E50CLS3	E50CNS3
Side Pushbutton, Maintained — E50DH1 		E50AH1 ☺☺	E50ALH1	E50ANH1	E50BH1	E50BLH1	E50BNH1	E50CLH1	E50CNH1
Wiring:		Single Pole 1N.O.-1N.C. Must be same polarity 			Double Pole 2N.O.-2N.C. Parallel wired Indicator light Same polarity each pole 			Double Pole 1N.O.-2N.C. Series wired Indicator light Same polarity each pole 	

① Connection options (add the Code Suffix from the table below to the end of the Catalog Number):



Option	Code Suffix	
Mini-Connector (with epoxy filled receptacle)	Single Pole (5-Pin Mini-Connector)	P5
	Double Pole (9-pin Mini-Connector)	P9
Cable Connection (with epoxy filled receptacle)	8-foot cable length	S
	12-foot cable length	S12
	20-foot cable length	S20
Manifold Mount (rear wiring entrance)	M	
20 mm Conduit Entrance	20	





② For Operating Head specifications, see Page 5.

③ CW (clockwise) and CCW (counterclockwise) operation, easily convertible to CW only or CCW only operation.

④ Roller can be converted in the field between horizontal and vertical.

Model Selection — Assembled Switches — Standard (Continued)

	Single Pole (5 Terminal Receptacle) 			Double Pole (9 Terminal Receptacle) 					
	Indicating Light:	None	LED (24 – 120V AC/DC)	Neon (120V AC)	None	LED (24 – 120V AC/DC)	Neon (120V AC)	LED (24 – 120V AC/DC)	Neon (120V AC)
	Switch Body:	E50SA 1N.O.-1N.C.	E50SAL 1N.O.-1N.C.	E50SAN 1N.O.-1N.C.	E50SB 2N.O.-2N.C.	E50SBL 2N.O.-2N.C.	E50SBN 2N.O.-2N.C.	E50SCL 1N.O.-2N.C.	E50SCN 1N.O.-2N.C.
	Receptacle: ①	E50RA	E50RA	E50RA	E50RB	E50RB	E50RB	E50RB	E50RB

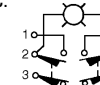
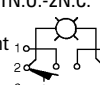
Operating Head Type ②		Catalog Number for Assembled Switches							
Top Pushbutton, Spring Return — E50DT1 	CE	E50AT1	E50ALT1	E50ANT1	E50BT1	E50BLT1	E50BNT1	E50CLT1	E50CNT1
Top Pushbutton, Adjustable Spring Return — E50DT2 	CE	E50AT2	E50ALT2	E50ANT2	E50BT2	E50BLT2	E50BNT2	E50CLT2	E50CNT2
Top Push Roller, Spring Return — E50DT3 	CE	E50AT3	E50ALT3	E50ANT3	E50BT3	E50BLT3	E50BNT3	E50CLT3	E50CNT3
Wobble Head, Spring Return (requires a wobble operator, see PG.05C.04.T.E) 	Standard Duty — E50DW1	E50AW1	E50ALW1	E50ANW1	E50BW1	E50BLW1	E50BNW1	E50CLW1	E50CNW1
	Heavy-Duty High Strength Steel — E50DW2	CE	E50AW2	E50ALW2	E50ANW2	E50BW2	E50BLW2	E50BNW2	E50CLW2
Wiring:	Single Pole 1N.O.-1N.C. Must be same polarity 	Double Pole 2N.O.-2N.C. Parallel wired Indicator light Same polarity each pole 			Double Pole 1N.O.-2N.C. Series wired Indicator light Same polarity each pole 				

① Connection options (add the Code Suffix from the table below to the end of the Catalog Number):





Option	Code Suffix	
Mini-Connector (with epoxy filled receptacle)	Single Pole (5-Pin Mini-Connector)	P5
	Double Pole (9-pin Mini-Connector)	P9
Cable Connection (with epoxy filled receptacle)	8-foot cable length	S
	12-foot cable length	S12
	20-foot cable length	S20
Manifold Mount (rear wiring entrance)	M	
20 mm Conduit Entrance	20	

② For Operating Head specifications, see Page 5.

③ CW (clockwise) and CCW (counterclockwise) operation, easily convertible to CW only or CCW only operation.

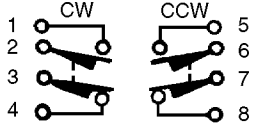
④ Roller can be converted in the field between horizontal and vertical.

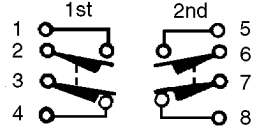
Model Selection — Assembled Switches — Special Purpose

	Operating Data — Nominal	Catalog Number				Circuit Diagram
		Assembled Switch	Switch Body Only	Receptacle Only	Operating Head Only	
Neutral Position (requires an operating lever, see PG.05C.04.T.E) 	5° Travel	E50NN1	E50SN	E50RB	E50DN1	Same Polarity Each Pole 
	15° Travel	E50NN2	E50SN	E50RB	E50DN2	
	Travel to Operate Contacts: Travel to Reset Contacts: Total Travel: Force to Operate Contacts: Minimum Return Force: Operating Temperature:	5° or 15° (depending upon model selected) 2° 90° 1.8 in-lbs 2.5 in-oz 14° to 200°F (-10° to 94°C)				
Two Step CW, CCW or both, Convertible (requires an operating lever, see PG.05C.04.T.E) 		E50TD1	E50ST	E50RB	E50DD1	Same Polarity Each Pole 
	Travel to Operate Contacts: Travel to Reset Contacts: Total Travel: Force to Operate Contacts: Minimum Return Force: Operating Temperature:	1st Step 10°; 2nd Step 10° 4° Each 90° 3 in-lbs 4.5 in-oz CW or CCW: 14° to 250°F (-10° to 121°C) CW and CCW: 14° to 200°F (-10° to 94°C)				
Gravity Return (requires E50KL220, E50KL226 or equivalent operating lever, see PG.05C.04.T.E) 	without Indicating Light	E50GG1	E50SG	E50RA	E50DG1	Must Be Same Polarity 
	with LED Indicating Light (24-120V AC/DC)	E50GLG1	E50SGL			
	with Neon Indicating Light (120V AC)	E50NGG1	E50SGN			
	Travel to Operate Contacts: Travel to Reset Contacts: Total Travel: Force to Operate Contacts: Minimum Return Force: Operating Temperature:	10° to 170° 8° 90° 1.8 in-lbs 2.5 in-oz 14° to 200°F (-10° to 94°C)				

Model Selection — Operating Heads

Description	Travel to Operate Contacts	Travel to Reset Contacts	Total Travel	Force to Operate Contacts	Minimum Return Force	Operating Temperature ^①		Catalog Number	
						Without Cable	With Pre-Wired Cable		
Side Rotary (requires an operating lever, see PG.05C.04.T.E) 	Standard Spring Return ^②	5°	2°	90°	3 in-lbs	4.5 in-oz	10° to 200°F (-12° to 94°C) ^③	10° to 200°F (-12° to 94°C) ^③	E50DR1
	Low ^② Temperature Spring Return	5°	2°	90°	3 in-lbs	4.5 in-oz	-40° to 175°F (-40° to 79°C)	-31° to 175°F (-34° to 79°C)	E50DR19
	Low Force Spring Return ^②	15°	6°	90°	1.5 in-lbs	2.5 in-oz	10° to 200°F (-12° to 94°C) ^③	10° to 200°F (-12° to 94°C) ^③	E50DL1
	Maintained Two-Position	50°	50°	90°	3 in-lbs	—	14° to 200°F (-10° to 94°C)	14° to 200°F (-10° to 94°C)	E50DM1
Side Pushbutton, Spring Return 	0.065 inch	0.030 inch	0.250 inch	4 lbs	8 oz	14° to 200°F (-10° to 94°C)	14° to 200°F (-10° to 94°C)	E50DS1	
Side Pushbutton, Adjustable Spring Return 	0.065 inch	0.030 inch	0.250 inch	4 lbs	8 oz	14° to 200°F (-10° to 94°C)	14° to 200°F (-10° to 94°C)	E50DS2	
Side Push Roller, Spring Return ^④ 	0.065 inch	0.030 inch	0.250 inch	4 lbs	8 oz	14° to 200°F (-10° to 94°C)	14° to 200°F (-10° to 94°C)	E50DS3 ^⑤	
								E50DS4 ^⑤	
Side Pushbutton, Maintained 	0.200 inch	0.130 inch	0.320 inch	5 lbs	5 lbs	14° to 200°F (-10° to 94°C)	14° to 200°F (-10° to 94°C)	E50DH1	
Top Pushbutton, Spring Return 	0.040 inch	0.020 inch	0.280 inch	4 lbs	8 oz	14° to 250°F (-10° to 121°C)	14° to 221°F (-10° to 105°C)	E50DT1	
Top Pushbutton, Adjustable Spring Return 	0.040 inch	0.020 inch	0.280 inch	4 lbs	8 oz	14° to 250°F (-10° to 121°C)	14° to 221°F (-10° to 105°C)	E50DT2	
Top Push Roller, Spring Return 	0.040 inch	0.020 inch	0.280 inch	4 lbs	8 oz	14° to 250°F (-10° to 121°C)	14° to 221°F (-10° to 105°C)	E50DT3	
Wobble Head, Spring Return (requires a wobble operator, see PG.05C.04.T.E) 	Standard Duty	10°	6°	15°	2 in-lbs	2.4 in-oz	14° to 250°F (-10° to 121°C)	14° to 221°F (-10° to 105°C)	E50DW1
	Heavy-Duty High Strength Steel	10°	6°	15°	2 in-lbs	2.4 in-oz	14° to 250°F (-10° to 121°C)	14° to 221°F (-10° to 105°C)	E50DW2

^① Temperature ranges below +32°F (0°C) are based on absence of freezing moisture or water.

^② CW (clockwise) and CCW (counterclockwise) operation, easily convertible to CW only or CCW only operation.

^③ For CW and CCW operation. For CW only or CCW only operation, high temperature limit increases to 250°F (121°C) without cable, and 221°F (105°C) with prewired cable.

^④ Roller can be converted in the field between horizontal and vertical.



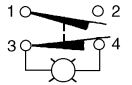
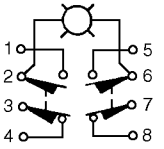
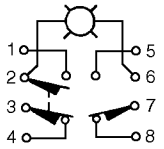

^⑤ Roller shaft is 0.38 inches (9.5 mm) longer on E50DS4, see dimensions on Page 11.

Model Selection — Switch Bodies

	Circuit	Switch Body Construction	Catalog Number
	Single Pole 1N.O.-1N.C. Must Be Same Polarity ① 	Without Indicating Light	E50SA CE
		With LED Indicating Light 24 – 120V AC/DC	E50SAL
		With Neon Indicating Light 120V AC	E50SAN
	Double Pole 2N.O.-2N.C. Parallel Wired Ind. Light Same Polarity Each Pole 	Without Indicating Light	E50SB
		With LED Indicating Light 24 – 120V AC/DC	E50SBL
		With Neon Indicating Light 120V AC	E50SBN
	Double Pole 2N.C.-1N.O. Series Wired Ind. Light Same Polarity Each Pole ① 	With LED Indicating Light 24 – 120V AC/DC	E50SCL
		With Neon Indicating Light 120V AC	E50SCN

① Indicating lights are supplied from the factory wired as shown. However, they can easily be re-connected to terminals 1 and 2 if necessary (SPDT).

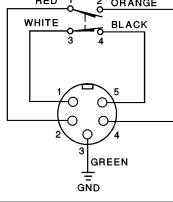
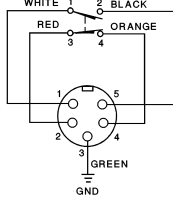
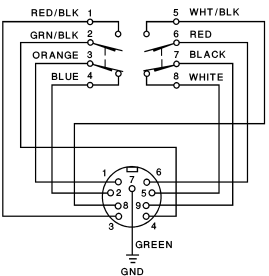
Model Selection — Receptacles

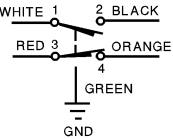
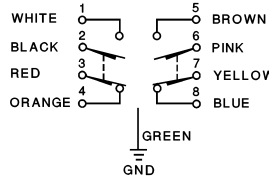
	Description	Poles	Conduit Entrance	Cable Length	Catalog Number	Wiring
Surface Mount 	Conduit entrance, front or rear mounting	Single Pole (5 Terminal)	1/2 NPT	—	E50RA	①
			20 mm	—	E50RA20	
		Double Pole (9 Terminal)	1/2 NPT	—	E50RB	①
			3/4 NPT	—	E50RB34	
Manifold Mount 	Rear wiring entrance instead of conduit hole, gasket on back for oil tightness	Single Pole (5 Terminal)	—	—	E50RAM	①
		Double Pole (9 Terminal)	—	—	E50RBM	①
Mini-Connector 	Epoxy filled receptacle with prewired Mini-Connector. (The -W version is a wiring scheme typically used in automotive applications.)	Single Pole (5 Terminal)	5-pin Mini-Connector	—	E50RAP5	② 
					E50RAP5-W	② 
		Double Pole (9 Terminal)	9-pin Mini-Connector	—	E50RBP9	② 
Prewired Cable 	Epoxy filled receptacle with prewired 16 gauge, yellow jacketed, type SOOW-A cable. Cable enters through hole threaded for conduit	Single Pole (5 Terminal)	1/2 NPT	8-foot	E50RAS	② 
				12-foot	E50RAS12	
				20-foot	E50RAS20	
			20 mm	8-foot	E50RA20S	
				12-foot	E50RA20S12	
				20-foot	E50RA20S20	
		Double Pole (9 Terminal)	1/2 NPT	8-foot	E50RBS	② 
				12-foot	E50RBS12	
20-foot	E50RBS20					
20 mm	8-foot		E50RB20S			
	12-foot	E50RB20S12				
20-foot	E50RB20S20					



① See Model Selection — Switch Bodies for wiring information.

② The wire colors referenced on these diagrams are those internal to the switch itself.

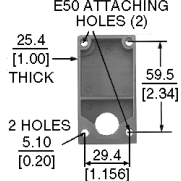
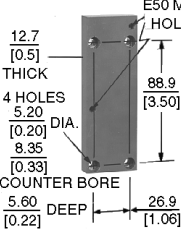
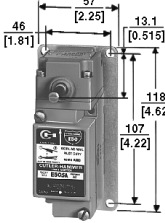
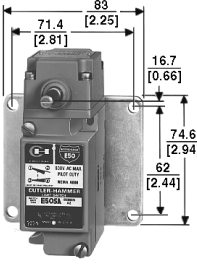
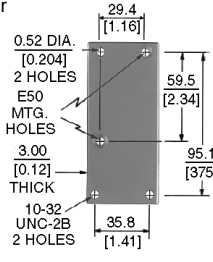
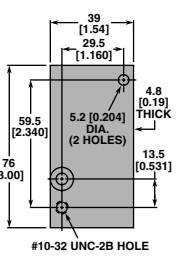
Model Selection — Accessories

Dimensions	Description	Catalog Number
	<p>Allows E50 to replace Cutler-Hammer 10316 Type LP Surface Mounting Plug-In Limit Switch</p> <p>Allows E50 to replace Cutler-Hammer 10316 Type LP Manifold Mounting Plug-In Limit Switch</p>	<p>E50KH1</p> <p>E50KH1M</p>
	<p>Allows E50 to replace Square D Type AW Surface Mounting Non Plug-In Standard Box Limit Switch</p>	<p>E50KH7</p>
	<p>Allows E50 to replace National Acme, Type D-1200M, Style 2 Mounting. Denison LoxSwitch, Model L-100W, Style 2 Mounting. Square D 9007 Type T, Style B Mounting. (Adapter plate is 1/8 inch thick, with 1/4 inch mounting holes.)</p>	<p>E50KH4 ①</p>
	<p>Allows E50 to replace National Acme, Type D-1200M, Style 1 Mounting. Denison LoxSwitch, Model L-100W, Style 1 Mounting. Square D 9007 Type T, Style C Mounting. (Adapter plate is 1/8 inch thick, with 1/4 inch mounting holes.)</p>	<p>E50KH5 ①</p>
	<p>Allows E50 to replace Cutler-Hammer 10316 Type LT Non Plug-In 2-Pole Limit Switch</p>	<p>E50KH2</p>
	<p>Allows E50 to replace Allen-Bradley 802M Sealed Limit Switch</p>	<p>E50KH10</p>

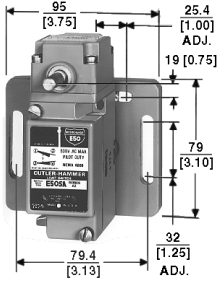
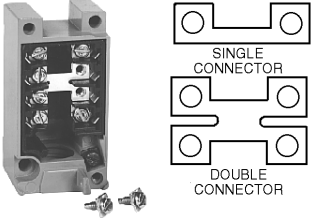
Model Selection — Accessories (Continued)

Dimensions	Description	Catalog Number
<p>Adjustable Mounting Plate</p> 	<p>This is a mounting plate only 5/16 inch thick and includes the proper mounting bolts and nuts. The slots in the plate allow a maximum horizontal adjustment of 1 inch and vertical adjustment of 1-1/4 inches</p>	<p>E50KH3 ①</p>
<p>Jumpers for Two-Pole Receptacles</p> 	<p>Jumpers for series, parallel or series-parallel connection of 2-pole limit switches. Kit consists of one double and four single connectors. Photo shows installation of double connector, two screws removed for clarity</p>	<p>E50KH8</p>
<p>Conduit Sealing Nut</p> 	<p>1/2 inch oiltight</p>	<p>E50KH6</p>

① Limit Switch not included.

Specifications

Environmental Ratings	NEMA 1, 3, 3S, 4, 4X, 6, 6P, 13, IP67
Enclosure Construction	Zinc die cast
Switch Gasket Material	Viton®
Universal U.S./DIN Mounting Dimensions	1.16 in (30 mm) x 2.34 in (60 mm)
Conduit Entrance	1/2 in NPT or 20 mm threading
Contact Ratings	See below
Contact Operation	Snap action over center mechanism
Contact Material	Fine silver
Maximum Frequency of Operation	8000 operations per hour
Mechanical Life: Side Rotary Side or Top Push	13,000,000 operations minimum 10,000,000 operations minimum
Electrical Life: Single Pole Double Pole	1,000,000 operations typical at full load 100,000 operations typical at full load
Ambient Temperature Range — Standard Standard without Cable Standard with Cable Low Temperature without Cable Low Temperature with Cable	14° to 250°F (-10° to 121°C) 14° to 221°F (-10° to 105°C) -40° to 250°F (-40° to 121°C) -40° to 221°F (-40° to 105°C)
Repeat Accuracy — Standard Side Operated Top Operated Side Rotary	Within 0.0012 in Within 0.0003 in Within 0.0014 in
Torque Requirements: Switch Body Screws Operating Head Screws	25 – 30 lb-in 14 – 18 lb-in
Wire Size	Will accept AWG #22 – #12, single or stranded wire

Electrical Data — Maximum Contact Ratings (Same polarity each pole)

AC Volts	Current, Amperes			Voltamperes		DC Volts	Current, Amperes	
	Make	Break	Cont. ①	Make	Break		Max. Make or Break	Cont. ①

All Switches Except Gravity Return and Indicating Light Versions

NEMA A600 Rating						NEMA R300		
120	60	6	10	7200	720	125	0.22	1.0
240	30	3				250	0.11	1.0
480	15	1.5						
600	12	1.2						

Switches with Indicating Lights (LED or Neon)

NEMA A150 Rating						NEMA R150		
120	60	6	10	7200	720	125	0.22	1.0

Gravity Return Switches — Maximum Contact Ratings

NEMA 6600 Rating — Contacts on Same Polarity						—		
120	30	3	5	3600	360	—	—	—
240	15	1.5						
480	7.5	0.75						
600	6	0.60						

① Thermal rating. Valid only if switch does not have to make or break.

Approximate Dimensions in Inches (mm)

Standard

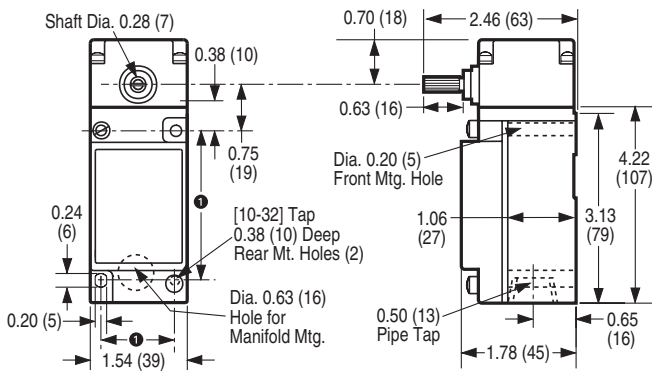

E50SB34

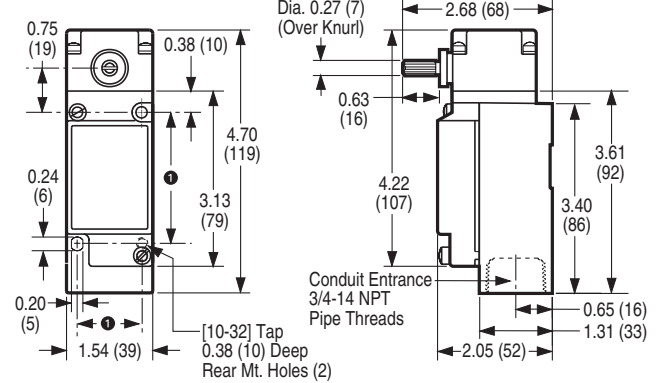

● Can accommodate both U.S., 1.16 (29.4) x 2.34 (59.5) and DIN, 1.18 (30) x 3.26 (60), mounting dimensions.

Side Push Operators in mm [Inches]

Pushbutton

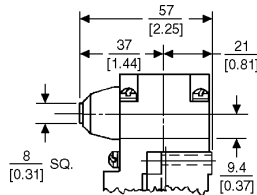

Top Push Operators in mm [Inches]

Pushbutton

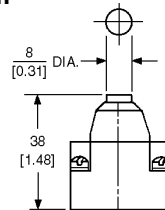

Wobble Operators

See Operators in PG.05C.04.T.E

Adjustable Pushbutton

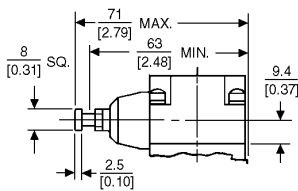

Adjustable Pushbutton

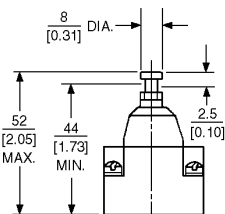

Roller

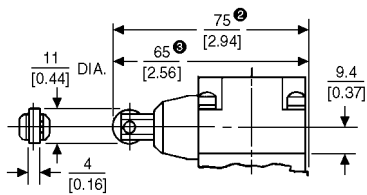

- For E50DS4.
- For E50DS3.

Roller

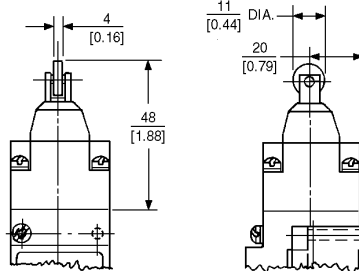

Maintained Pushbutton

