

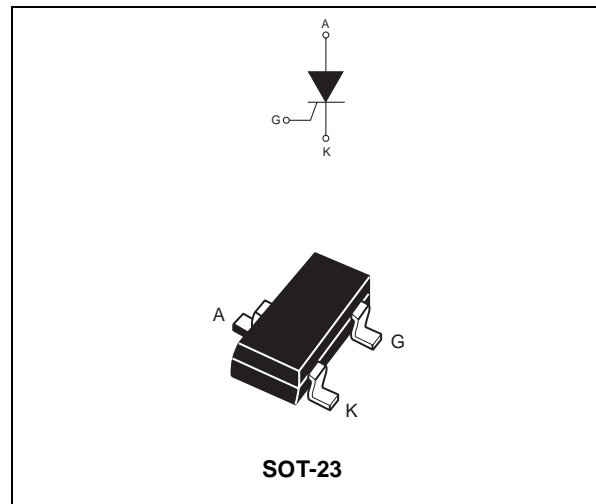
### MAIN FEATURES:

Symbol	Value	Unit
$I_{T(RMS)}$	0.25	A
$V_{DRM}/V_{RRM}$	200	V
$I_{GT}$	200	$\mu A$

### DESCRIPTION

Thanks to highly sensitive triggering levels, the PO102BL SCR is suitable for all applications where the available gate current is limited such as stand-by mode power supplies, smoke and alarm detectors...

Available in SOT-23, it provides optimized space saving on high density printed circuit boards.



### ABSOLUTE RATINGS (limiting values)

Symbol	Parameter		Value	Unit
$I_{T(RMS)}$	RMS on-state current (180° conduction angle)		$T_{amb} = 30^{\circ}C$	0.25 A
$I_{T(AV)}$	Average on-state current (180° conduction angle)		$T_{amb} = 30^{\circ}C$	0.17 A
$I_{TSM}$	Non repetitive surge peak on-state current	$t_p = 8.3 \text{ ms}$	$T_j = 25^{\circ}C$	7
		$t_p = 10 \text{ ms}$		6
$I^2t$	$I^2t$ Value for fusing	$t_p = 10 \text{ ms}$	$T_j = 25^{\circ}C$	0.18 $A^2s$
$di/dt$	Critical rate of rise of on-state current $I_G = 2 \times I_{GT}$ , $t_r \leq 100ns$	F = 60 Hz	$T_j = 125^{\circ}C$	50 $A/\mu s$
$I_{GM}$	Peak gate current	$t_p = 20 \mu s$	$T_j = 125^{\circ}C$	0.5 A
$P_{G(AV)}$	Average gate power dissipation		$T_j = 125^{\circ}C$	0.02 W
$T_{stg}$ $T_j$	Storage junction temperature range Operating junction temperature range			- 40 to + 150 - 40 to + 125 $^{\circ}C$

**ELECTRICAL CHARACTERISTICS** (T<sub>j</sub> = 25°C, unless otherwise specified)

Symbol	Test Conditions		P0102BL	Unit	
I <sub>GT</sub>	V <sub>D</sub> = 12 V R <sub>L</sub> = 140 Ω	MAX.	200	μA	
V <sub>GT</sub>		MAX.	0.8	V	
V <sub>GD</sub>	V <sub>D</sub> = V <sub>DRM</sub> R <sub>L</sub> = 3.3 kΩ R <sub>GK</sub> = 1 kΩ	T <sub>j</sub> = 125°C	MIN.	0.1	V
V <sub>RG</sub>	I <sub>RG</sub> = 10 μA		MIN.	8	V
I <sub>H</sub>	I <sub>T</sub> = 50 mA R <sub>GK</sub> = 1kΩ		MAX.	6	mA
I <sub>L</sub>	I <sub>G</sub> = 1 mA R <sub>GK</sub> = 1kΩ		MAX.	7	mA
dV/dt	V <sub>D</sub> = 67 % V <sub>DRM</sub> R <sub>GK</sub> = 1kΩ	T <sub>j</sub> = 125°C	MIN.	200	V/μs
V <sub>TM</sub>	I <sub>TM</sub> = 0.4 A tp = 380 μs	T <sub>j</sub> = 25°C	MAX.	1.7	V
V <sub>T0</sub>	Threshold voltage	T <sub>j</sub> = 125°C	MAX.	1.0	V
R <sub>d</sub>	Dynamic resistance	T <sub>j</sub> = 125°C	MAX.	1000	mΩ
I <sub>DRM</sub>	V <sub>DRM</sub> = V <sub>RDM</sub>	T <sub>j</sub> = 25°C	MAX.	1	μA
I <sub>RDM</sub>		T <sub>j</sub> = 125°C		100	

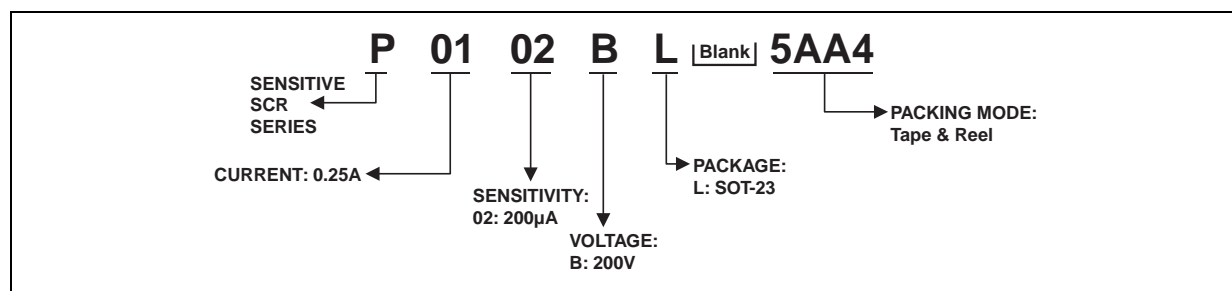
**THERMAL RESISTANCES**

Symbol	Parameter	Value	Unit
R <sub>th(j-a)</sub>	Junction to ambient (mounted on FR4 with recommended pad layout)	400	°C/W

**PRODUCT SELECTOR**

Part Number	Voltage	Sensitivity	Package
P0102BL	200 V	200 μA	SOT-23

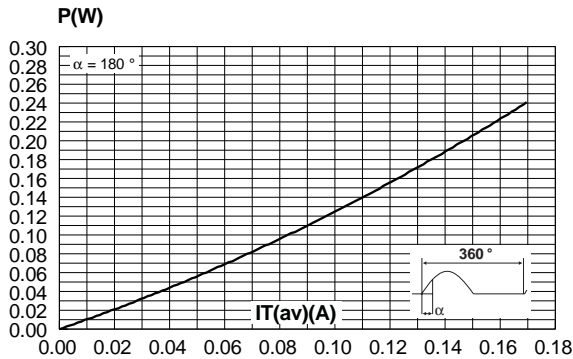
**ORDERING INFORMATION**



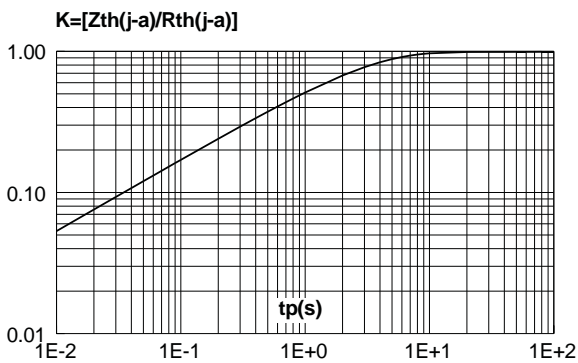
**OTHER INFORMATION**

Part Number	Marking	Weight	Base quantity	Packing mode
P0102BL	P2B	0.01 g	3000	Tape & reel

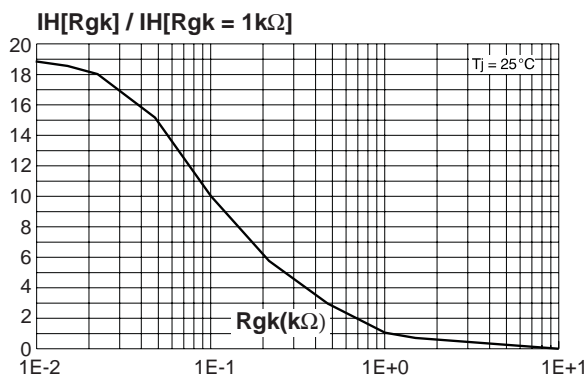
**Fig. 1:** Maximum average power dissipation versus average on-state current.



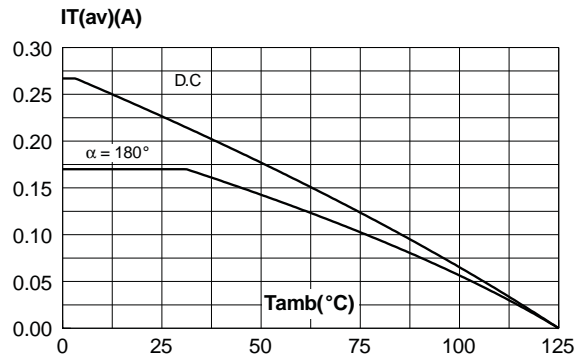
**Fig. 3:** Relative variation of thermal impedance junction to ambient versus pulse duration.



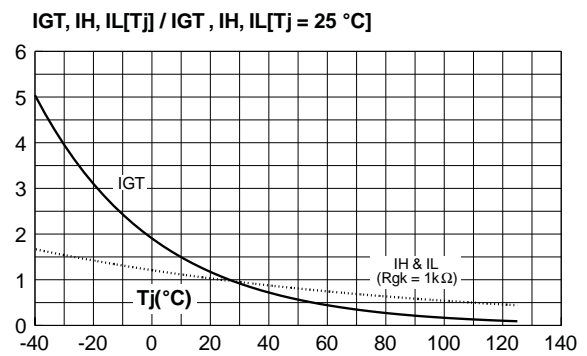
**Fig. 5:** Relative variation of holding current versus gate-cathode resistance (typical values).



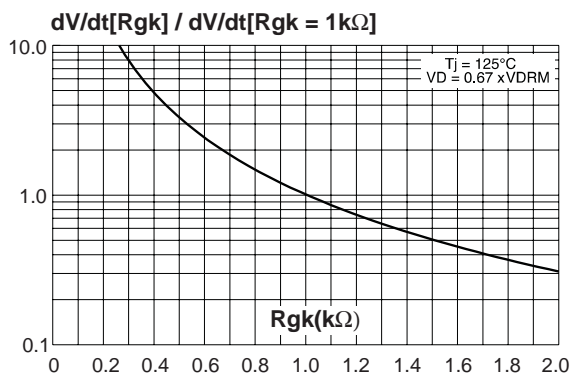
**Fig. 2:** Average and D.C. on-state current versus ambient temperature.



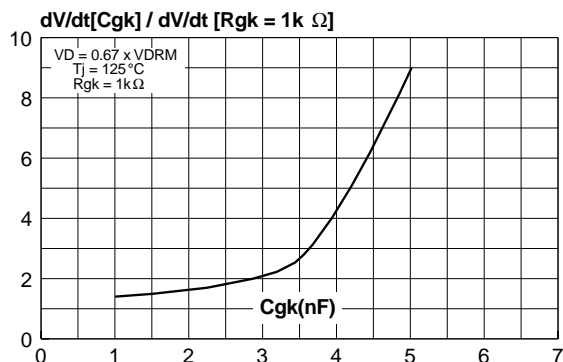
**Fig. 4:** Relative variation of gate trigger current, holding current and latching current versus junction temperature (typical values).



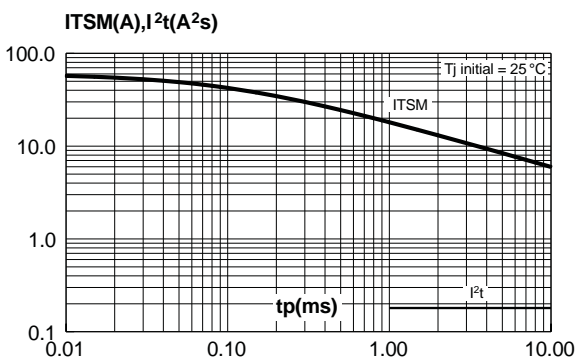
**Fig. 6:** Relative variation of dV/dt immunity versus gate-cathode resistance (typical values).



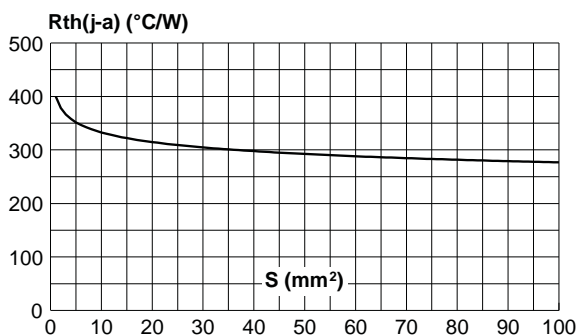
**Fig. 7:** Relative variation of dV/dt immunity versus gate-cathode capacitance (typical values).



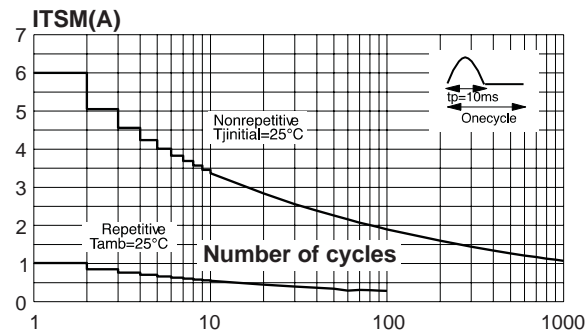
**Fig. 9:** Non-repetitive surge peak on-state current for a sinusoidal pulse with width  $t_p < 10ms$ , and corresponding value of  $I^2t$ .



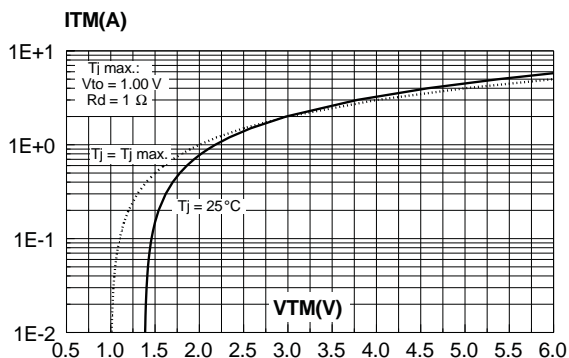
**Fig. 11:** Thermal resistance junction to ambient versus copper surface under tab (Epoxy printed circuit board FR4, copper thickness:  $35 \mu m$ ).



**Fig. 8:** Surge peak on-state current versus number of cycles.

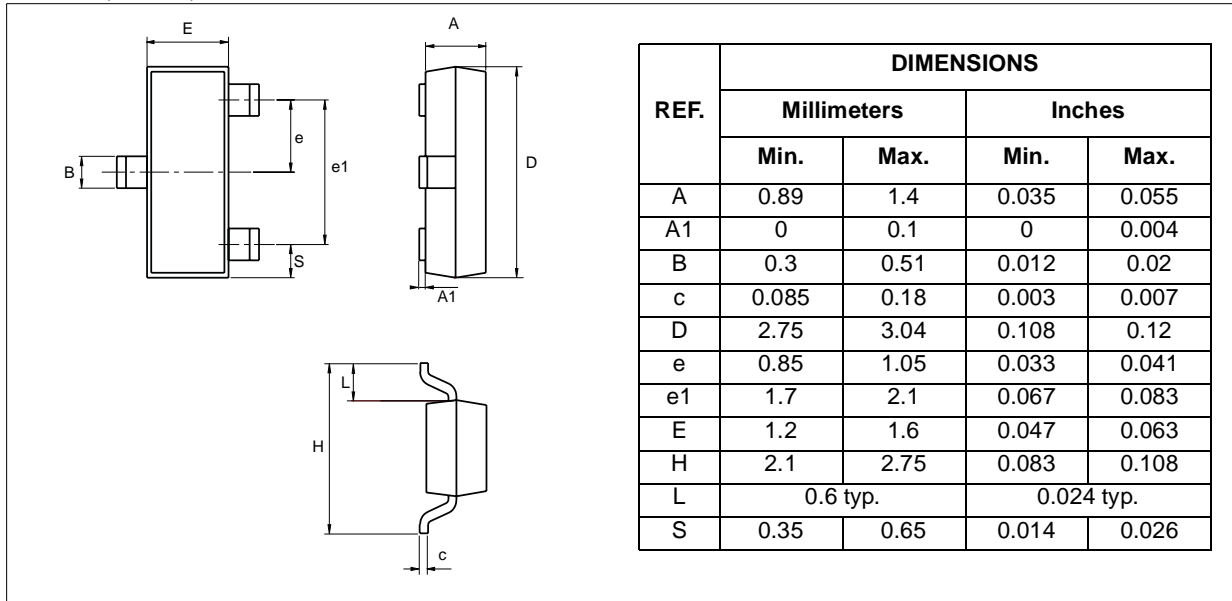


**Fig. 10:** On-state characteristics (maximum values).



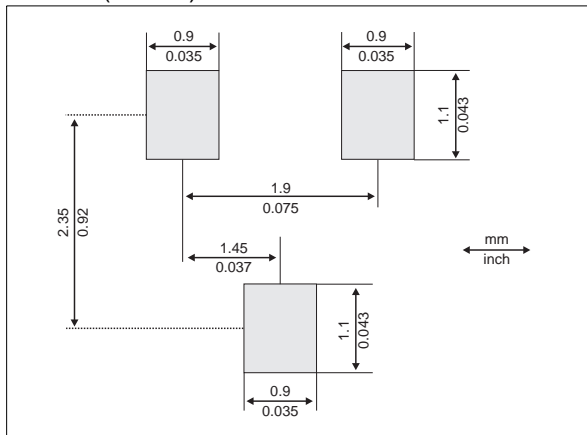
**PACKAGE MECHANICAL DATA**

SOT-23 (Plastic)



**FOOTPRINT DIMENSIONS (in millimeters)**

SOT-23 (Plastic)



Information furnished is believed to be accurate and reliable. However, STMicroelectronics assumes no responsibility for the consequences of use of such information nor for any infringement of patents or other rights of third parties which may result from its use. No license is granted by implication or otherwise under any patent or patent rights of STMicroelectronics. Specifications mentioned in this publication are subject to change without notice. This publication supersedes and replaces all information previously supplied. STMicroelectronics products are not authorized for use as critical components in life support devices or systems without express written approval of STMicroelectronics.

© The ST logo is a registered trademark of STMicroelectronic

© 2000 STMicroelectronics - Printed in Italy - All Rights Reserved

STMicroelectronics GROUP OF COMPANIES  
 Australia - Brazil - China - Finland - France - Germany - Hong Kong - India - Italy - Japan - Malaysia - Malta - Morocco  
 Singapore - Spain - Sweden - Switzerland - United Kingdom

