

NPN Silicon RF Transistor

- High linearity low noise driver amplifier
- Output compression point 19.5 dBm @ 1.8 GHz
- Ideal for oscillators up to 3.5 GHz
- Low noise figure 1.1 dB at 1.8 GHz
- Collector design supports 5V supply voltage
- Pb-free (RoHS compliant) package
- Qualified according AEC Q101

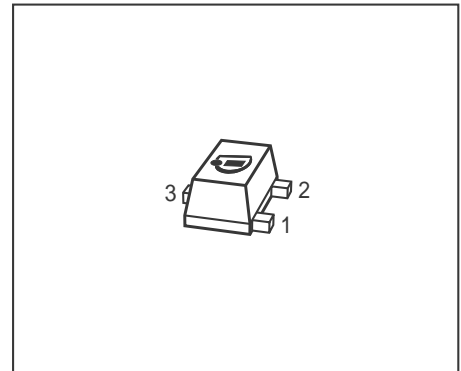

ESD (Electrostatic discharge) sensitive device, observe handling precaution!

Type	Marking	Pin Configuration			Package
BFR380F	FCs	1 = B	2 = E	3 = C	TSFP-3

Maximum Ratings

Parameter	Symbol	Value	Unit
Collector-emitter voltage	V_{CEO}	6	V
Collector-emitter voltage	V_{CES}	15	
Collector-base voltage	V_{CBO}	15	
Emitter-base voltage	V_{EBO}	2	
Collector current	I_C	80	mA
Base current	I_B	14	
Total power dissipation ¹⁾ $T_S \leq 95^\circ\text{C}$	P_{tot}	380	mW
Junction temperature	T_J	150	°C
Ambient temperature	T_A	-65 ... 150	
Storage temperature	T_{Stg}	-65 ... 150	

Thermal Resistance

Parameter	Symbol	Value	Unit
Junction - soldering point ²⁾	R_{thJS}	≤ 145	K/W

¹⁾ T_S is measured on the collector lead at the soldering point to the pcb

²⁾ For calculation of R_{thJA} please refer to Application Note AN077 Thermal Resistance

Electrical Characteristics at $T_A = 25^\circ\text{C}$, unless otherwise specified

Parameter	Symbol	Values			Unit
		min.	typ.	max.	
DC Characteristics					
Collector-emitter breakdown voltage $I_C = 1\text{ mA}, I_B = 0$	$V_{(BR)CEO}$	6	9	-	V
Collector-emitter cutoff current $V_{CE} = 5\text{ V}, V_{BE} = 0$ $V_{CE} = 15\text{ V}, V_{BE} = 0$	I_{CES}	-	1	30	nA
		-	-	1000	
Collector-base cutoff current $V_{CB} = 5\text{ V}, I_E = 0$	I_{CBO}	-	-	30	
Emitter-base cutoff current $V_{EB} = 1\text{ V}, I_C = 0$	I_{EBO}	-	1	500	
DC current gain $I_C = 40\text{ mA}, V_{CE} = 3\text{ V}, \text{pulse measured}$	h_{FE}	90	120	160	-

Electrical Characteristics at $T_A = 25^\circ\text{C}$, unless otherwise specified

Parameter	Symbol	Values			Unit
		min.	typ.	max.	
AC Characteristics (verified by random sampling)					
Transition frequency $I_C = 40\text{ mA}$, $V_{CE} = 3\text{ V}$, $f = 1\text{ GHz}$	f_T	11	14	-	GHz
Collector-base capacitance $V_{CB} = 5\text{ V}$, $f = 1\text{ MHz}$, $V_{BE} = 0$, emitter grounded	C_{cb}	-	0.5	0.7	pF
Collector emitter capacitance $V_{CE} = 5\text{ V}$, $f = 1\text{ MHz}$, $V_{BE} = 0$, base grounded	C_{ce}	-	0.2	-	
Emitter-base capacitance $V_{EB} = 0.5\text{ V}$, $f = 1\text{ MHz}$, $V_{CB} = 0$, collector grounded	C_{eb}	-	1	-	
Minimum noise figure $I_C = 8\text{ mA}$, $V_{CE} = 3\text{ V}$, $Z_S = Z_{Sopt}$, $f = 1.8\text{ GHz}$ $I_C = 8\text{ mA}$, $V_{CE} = 3\text{ V}$, $Z_S = Z_{Sopt}$, $f = 3\text{ GHz}$	NF_{min}	-	1.1 1.6	-	dB
Power gain, maximum available ¹⁾ $I_C = 40\text{ mA}$, $V_{CE} = 3\text{ V}$, $Z_S = Z_{Sopt}$, $Z_L = Z_{Lopt}$, $f = 1.8\text{ GHz}$ $I_C = 40\text{ mA}$, $V_{CE} = 3\text{ V}$, $Z_S = Z_{Sopt}$, $Z_L = Z_{Lopt}$, $f = 3\text{ GHz}$	G_{ma}	-	13.5 9.5	-	
Transducer gain $I_C = 40\text{ mA}$, $V_{CE} = 3\text{ V}$, $Z_S = Z_L = 50\Omega$, $f = 1.8\text{ GHz}$ $f = 3\text{ GHz}$	$ S_{21e} ^2$	-	11 7	-	dB
Third order intercept point at output ²⁾ $V_{CE} = 3\text{ V}$, $I_C = 40\text{ mA}$, $Z_S = Z_L = 50\Omega$, $f = 1.8\text{ GHz}$	IP_3	-	29	-	dBm
1dB compression point at output $I_C = 40\text{ mA}$, $V_{CE} = 3\text{ V}$, $f = 1.8\text{ GHz}$ $Z_S = Z_L = 50\Omega$ $Z_S = Z_{Sopt}$, $Z_L = Z_{Lopt}$	P_{-1dB}	-	17 19.5	-	

$$^1G_{ma} = |S_{21e} / S_{12e}| (k - (k^2 - 1)^{1/2})$$

²⁾IP3 value depends on termination of all intermodulation frequency components.
Termination used for this measurement is 50Ω from 0.1 MHz to 6 GHz

Total power dissipation $P_{tot} = f(T_S)$

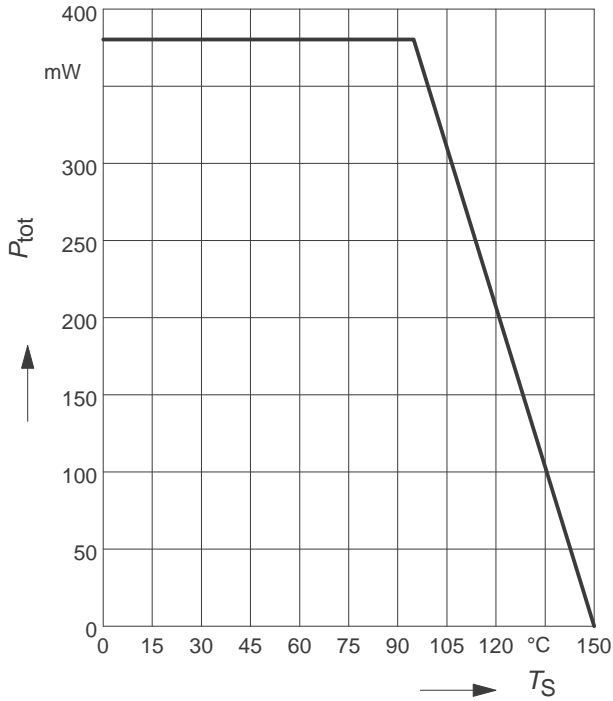

Permissible Pulse Load $R_{thJS} = f(t_p)$

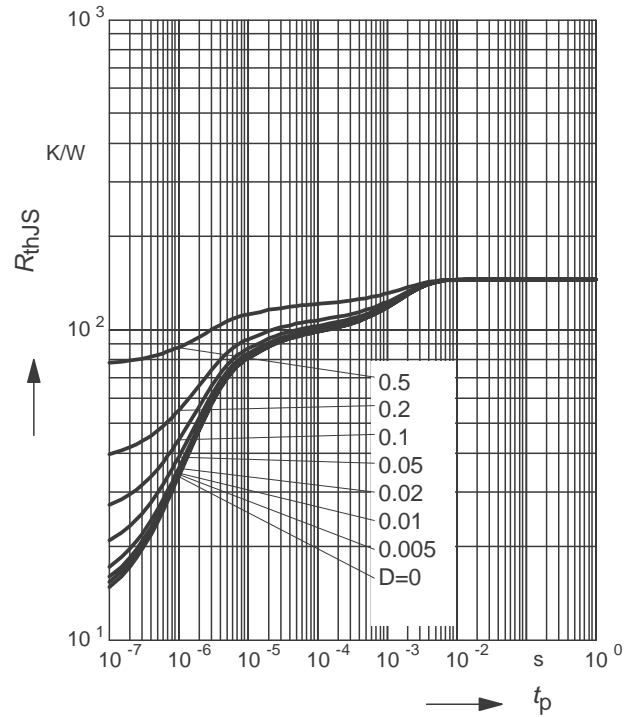

Permissible Pulse Load

$P_{totmax}/P_{totDC} = f(t_p)$

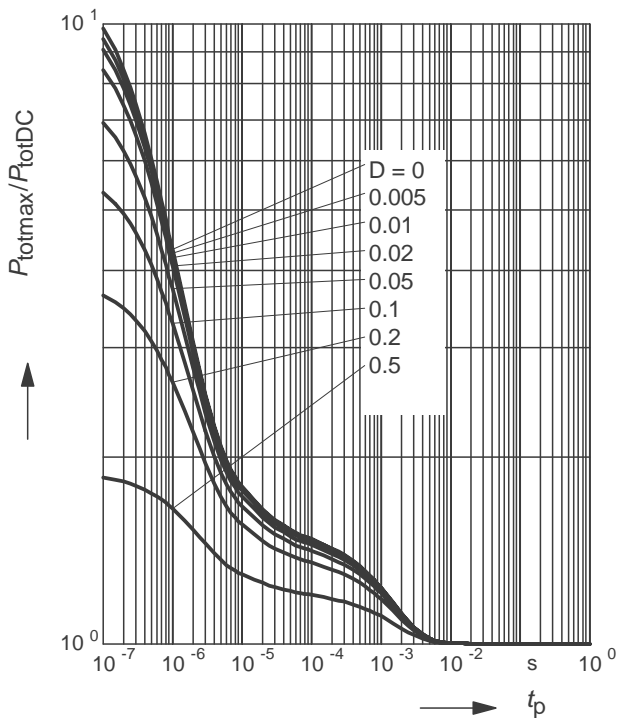

Collector-base capacitance $C_{cb} = f(V_{CB})$

$f = 1\text{MHz}$

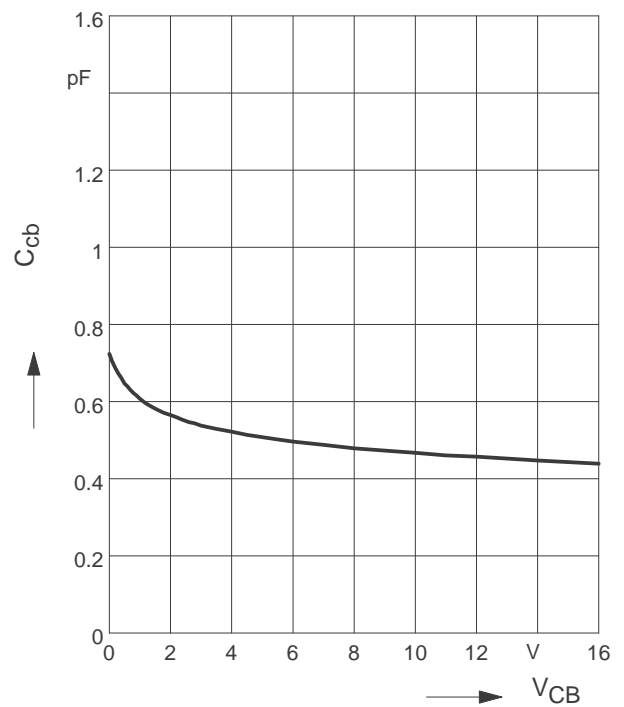

Third order Intercept Point $IP_3 = f(I_C)$

(Output, $Z_S = Z_L = 50\Omega$)

V_{CE} = parameter, $f = 1.8\text{GHz}$

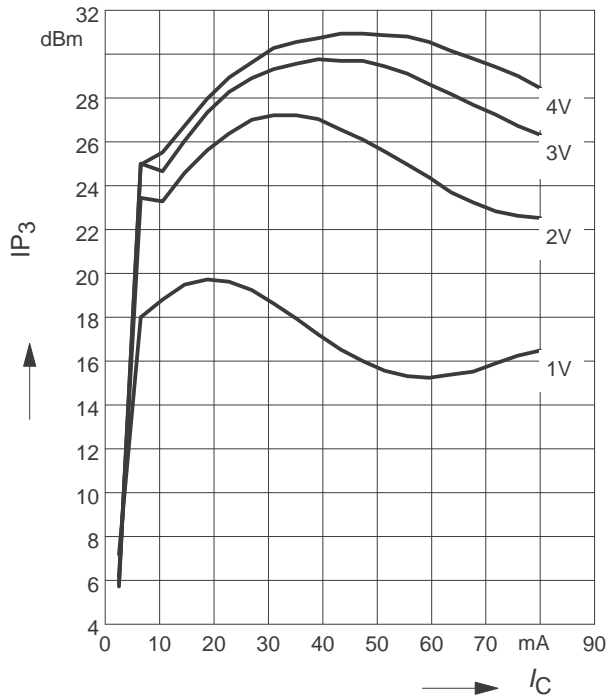

Third order Intercept Point $IP_3 = f(I_C)$

(Output, $Z_S = Z_L = 50\Omega$)

V_{CE} = parameter, $f = 900\text{MHz}$

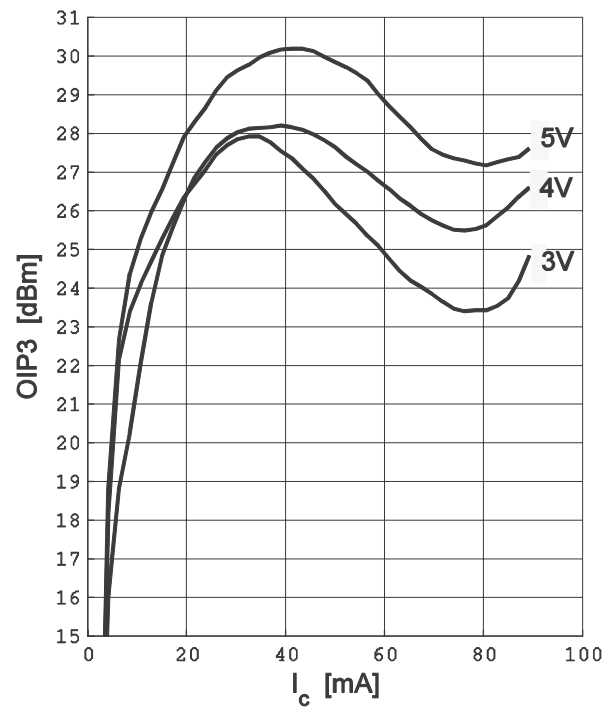

Transition frequency $f_T = f(I_C)$

$f = 1\text{GHz}$

V_{CE} = parameter

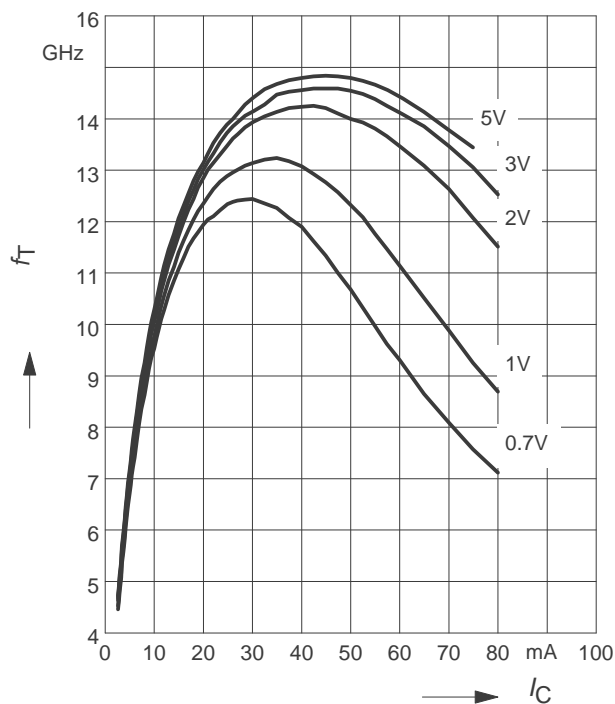

Power gain $G_{ma}, G_{ms} = f(I_C)$

$f = 1.8\text{GHz}$

V_{CE} = parameter

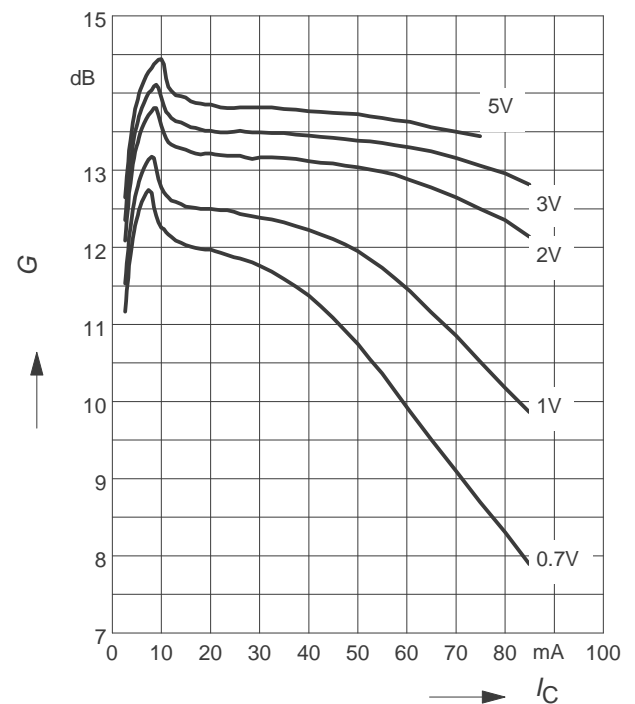

Power Gain $G_{ma}, G_{ms} = f(f)$
 $V_{CE} = \text{parameter}$

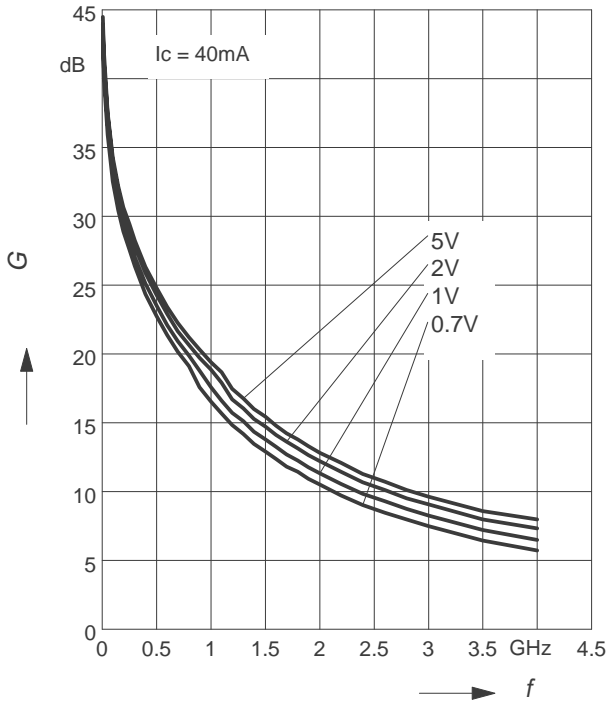

Power Gain $|S_{21}|^2 = f(f)$
 $V_{CE} = \text{parameter}$

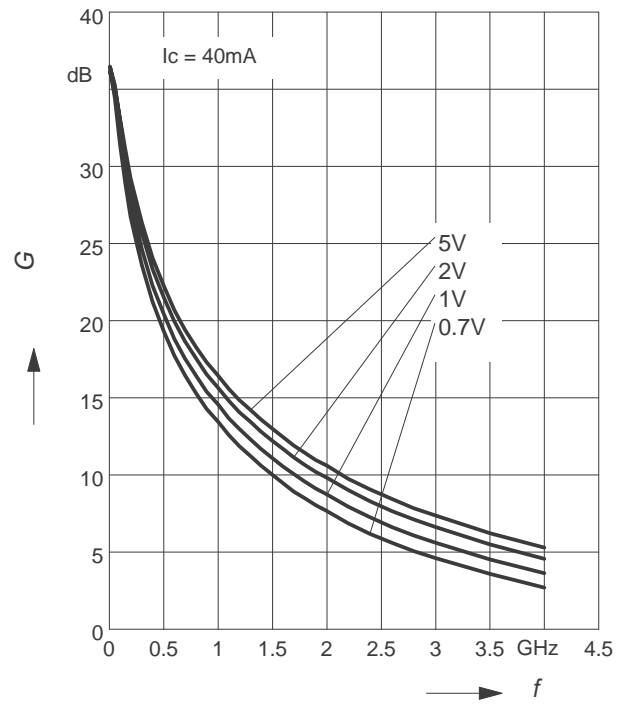

Power Gain $G_{ma}, G_{ms} = f(V_{CE})$: —
 $|S_{21}|^2 = f(V_{CE})$: - - - -
 $f = \text{parameter}$

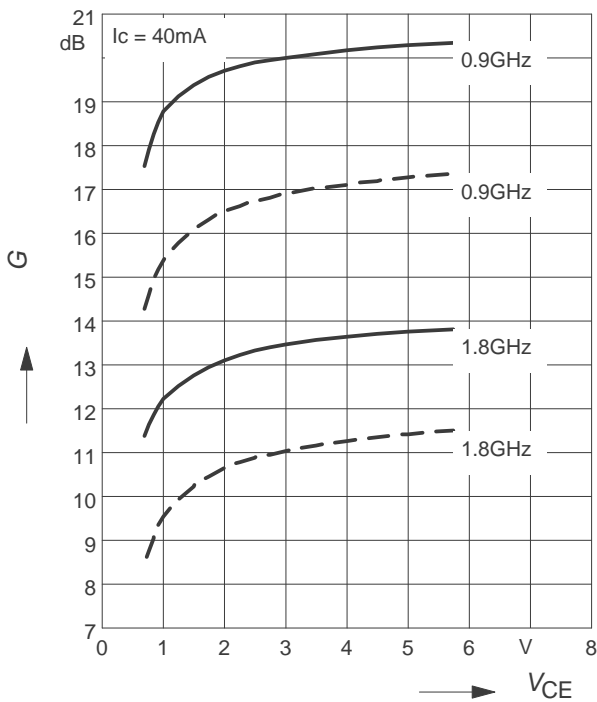

Power gain $G_{ma}, G_{ms} = f(I_C)$
 $V_{CE} = 3V$
 $f = \text{parameter}$

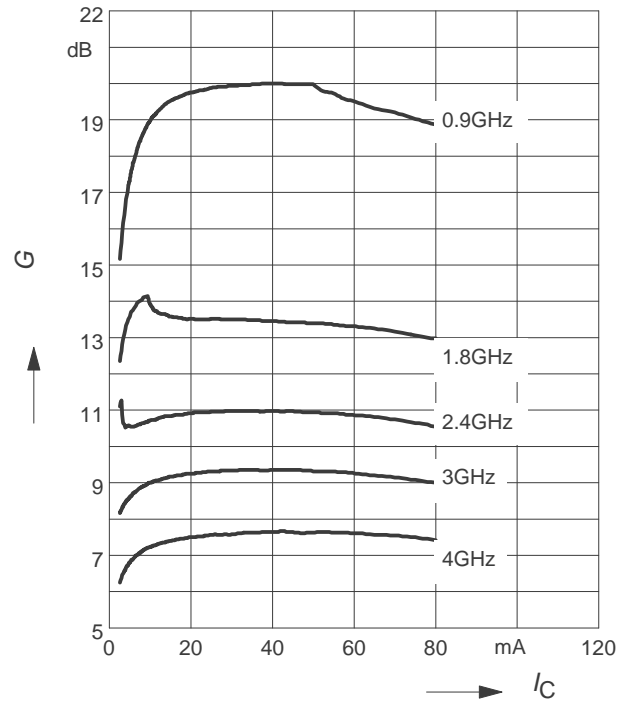

Minimum noise figure $NF_{min} = f(I_C)$

$V_{CE} = 3V, Z_S = Z_{Sopt}$

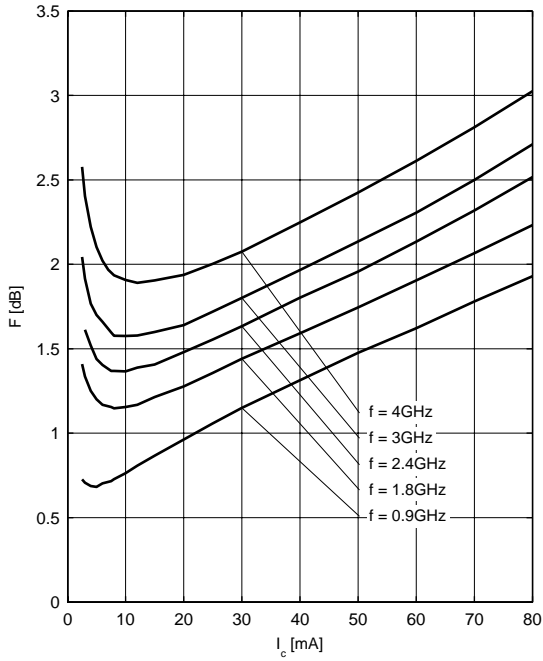

Noise figure $F = f(I_C)$

$V_{CE} = 3V, f = 1.8\text{ GHz}$

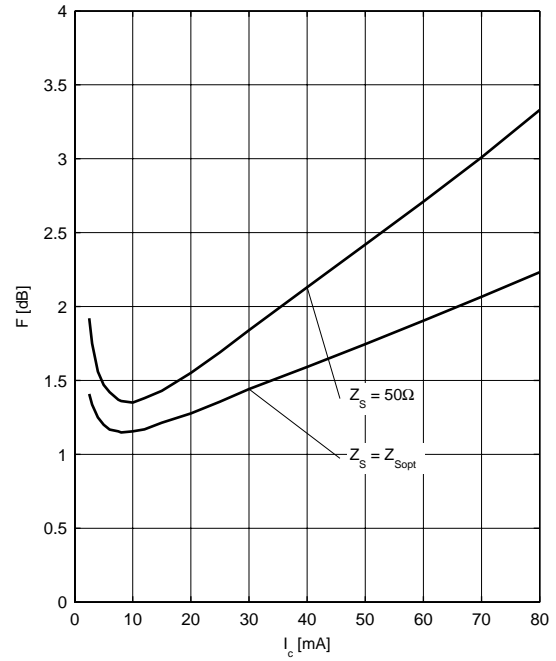

Minimum noise figure $NF_{min} = f(f)$

$V_{CE} = 3V, Z_S = Z_{Sopt}$

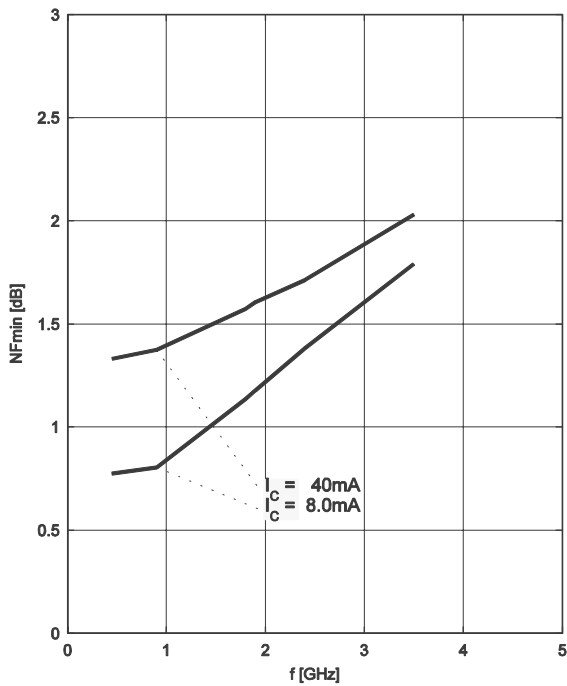

Source impedance for min.

noise figure vs. frequency

$V_{CE} = 3\text{ V}, I_C = 8.0\text{mA}/40.0\text{mA}$

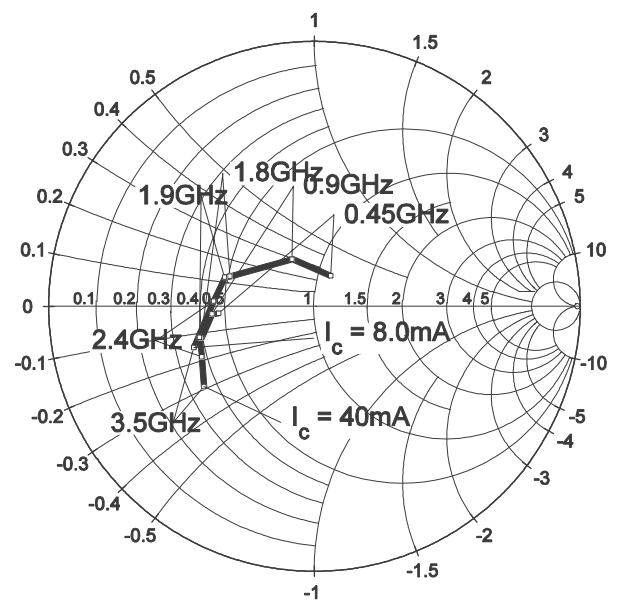

SPICE GP (Gummel-Poon)

For the SPICE Gummel Poon (GP) model as well as for the S-parameters (including noise parameters) please refer to our internet website www.infineon.com/rf.models.

Please consult our website and download the latest versions before actually starting your design. You find the BFR380F SPICE GP model in the internet in MWO- and ADS-format, which you can import into these circuit simulation tools very quickly and conveniently. The model already contains the package parasitics and is ready to use for DC and high frequency simulations. The terminals of the model circuit correspond to the pin configuration of the device. The model parameters have been extracted and verified up to 10 GHz using typical devices. The BFR380F SPICE GP model reflects the typical DC- and RF-performance within the limitations which are given by the SPICE GP model itself. Besides the DC characteristics all S-parameters in magnitude and phase, as well as noise figure (including optimum source impedance, equivalent noise resistance and flicker noise) and intermodulation have been extracted.

Package Outline

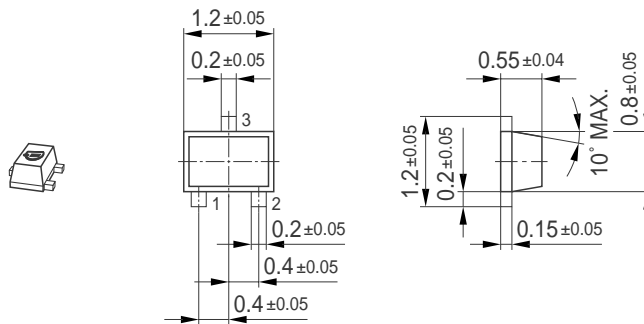

Foot Print

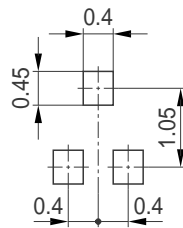

Marking Layout (Example)

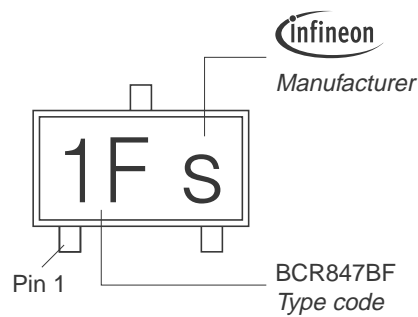

Standard Packing

Reel $\varnothing 180$ mm = 3.000 Pieces/Reel
 Reel $\varnothing 330$ mm = 10.000 Pieces/Reel

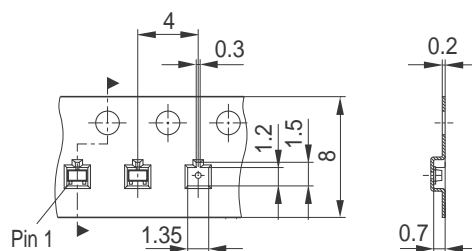

Datasheet Revision History: 13 September 2010

This datasheet replaces the revision from 20 May 2010. The product itself has not been changed and the device characteristics remain unchanged. Only the product description and information available in the datasheet has been expanded and updated.

Previous Revision: 20 May 2010	
Page	Subject (changes since last revision)
5	@ 900 MHz OIP3 curve added
8	SPICE model parameters removed from the datasheet, respective link to the internet site added

Edition 2009-11-16

**Published by
Infineon Technologies AG
81726 Munich, Germany**

**© 2009 Infineon Technologies AG
All Rights Reserved.**

Legal Disclaimer

The information given in this document shall in no event be regarded as a guarantee of conditions or characteristics. With respect to any examples or hints given herein, any typical values stated herein and/or any information regarding the application of the device, Infineon Technologies hereby disclaims any and all warranties and liabilities of any kind, including without limitation, warranties of non-infringement of intellectual property rights of any third party.

Information

For further information on technology, delivery terms and conditions and prices, please contact the nearest Infineon Technologies Office (www.infineon.com).

Warnings

Due to technical requirements, components may contain dangerous substances. For information on the types in question, please contact the nearest Infineon Technologies Office.

Infineon Technologies components may be used in life-support devices or systems only with the express written approval of Infineon Technologies, if a failure of such components can reasonably be expected to cause the failure of that life-support device or system or to affect the safety or effectiveness of that device or system. Life support devices or systems are intended to be implanted in the human body or to support and/or maintain and sustain and/or protect human life. If they fail, it is reasonable to assume that the health of the user or other persons may be endangered.