

Part Number: L-9294SYC-J3

Super Bright Yellow

Features

- High luminous emission.
- Low power consumption.
- General purpose leads.
- Reliable and rugged.
- Long life - solid state reliability.
- RoHS compliant.

Description

The Super Bright Yellow device is based on light emitting diode chip made from AlGaInP.

Package Dimensions

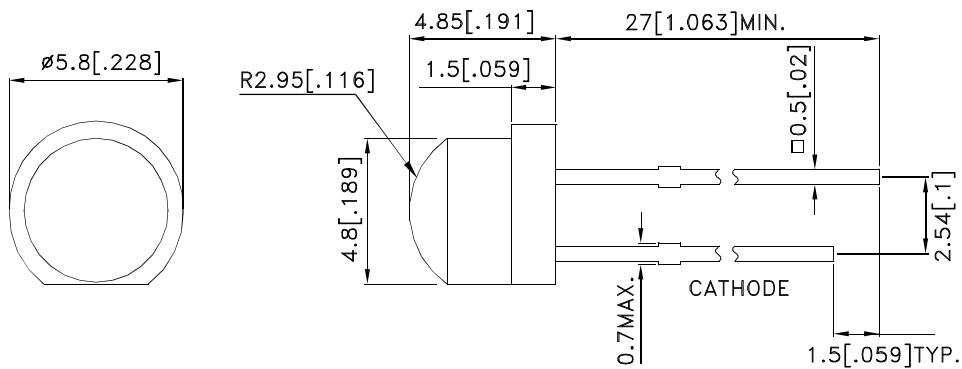

Notes:

1. All dimensions are in millimeters (inches).
2. Tolerance is ± 0.25 (0.01") unless otherwise noted.
3. Lead spacing is measured where the leads emerge from the package.
4. The specifications, characteristics and technical data described in the datasheet are subject to change without prior notice.



Selection Guide

Part No.	Dice	Lens Type	Iv (mcd) [2] @ 20mA		Viewing Angle [1]
			Min.	Typ.	2θ1/2
L-9294SYC-J3	Super Bright Yellow (AlGaInP)	Water Clear	400	700	130°

Notes:

1. θ1/2 is the angle from optical centerline where the luminous intensity is 1/2 of the optical peak value.
2. Luminous intensity/ luminous Flux: +/-15%.
3. Luminous intensity value is traceable to the CIE127-2007 compliant national standards.

Electrical / Optical Characteristics at TA=25°C

Symbol	Parameter	Device	Typ.		Max.	Units	Test Conditions
λ _{peak}	Peak Wavelength	Super Bright Yellow	590	*590		nm	I _F =20mA
λ _D [1]	Dominant Wavelength	Super Bright Yellow	589	*590		nm	I _F =20mA
Δλ _{1/2}	Spectral Line Half-width	Super Bright Yellow	20			nm	I _F =20mA
C	Capacitance	Super Bright Yellow	45			pF	V _F =0V;f=1MHz
V _F [2]	Forward Voltage	Super Bright Yellow	2		2.5	V	I _F =20mA
I _R	Reverse Current	Super Bright Yellow			10	uA	V _R = 5V

Notes:

1. Wavelength: +/-1nm.
 2. Forward Voltage: +/-0.1V.
- *Wavelength value is traceable to the CIE127-2007 compliant national standards.

Absolute Maximum Ratings at TA=25°C

Parameter	Super Bright Yellow	Units
Power dissipation	75	mW
DC Forward Current	30	mA
Peak Forward Current [1]	140	mA
Reverse Voltage	5	V
Operating/Storage Temperature	-40°C To +85°C	
Lead Solder Temperature [2]	260°C For 3 Seconds	
Lead Solder Temperature [3]	260°C For 5 Seconds	

Notes:

1. 1/10 Duty Cycle, 0.1ms Pulse Width.
2. 2mm below package base.
3. 5mm below package base.

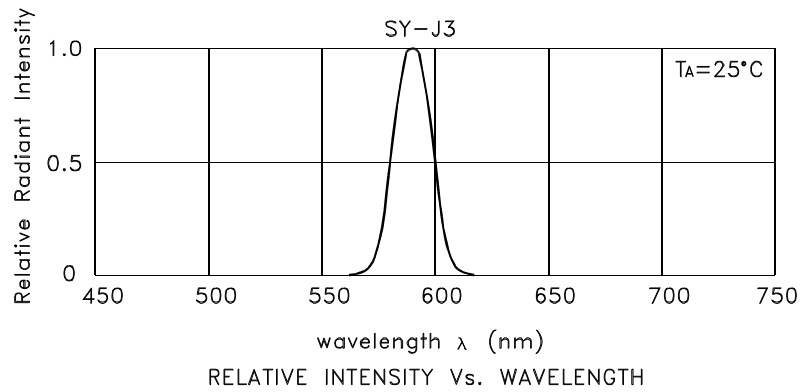

Super Bright Yellow L-9294SYC-J3

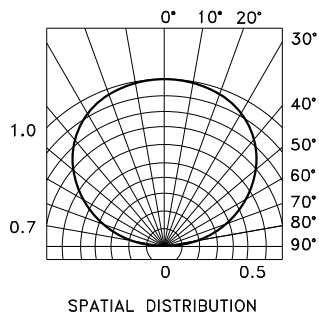
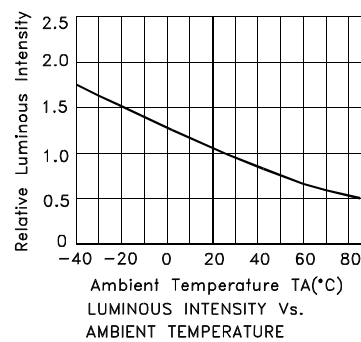
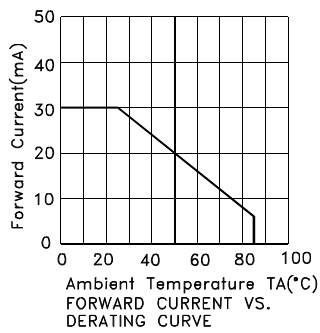
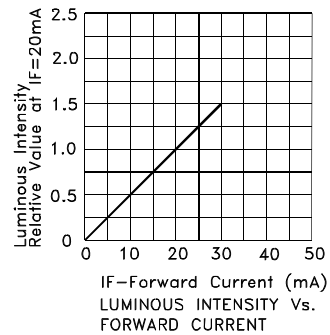
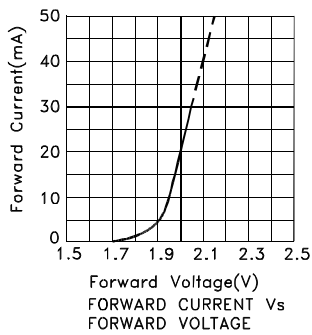

PACKING & LABEL SPECIFICATIONS

L-9294SYC-J3

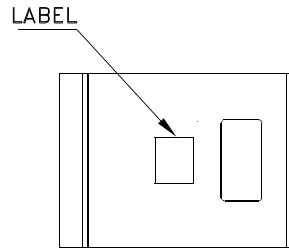
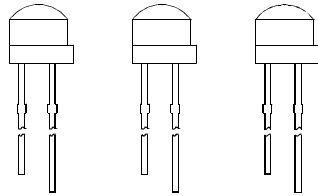

500 PCS / BAG



20K/BOX

OUTSIDE LABEL

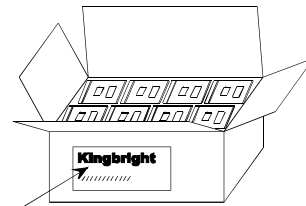

OUTSIDE LABEL

10K/BOX

Kingbright	
P/NO: L-9294xxx	
QTY: 500 pcs	Q.C. Q C XX XX XXXX PASSED
S/N: XXXX	
CODE: XXX	
LOT NO:	
 XXXXXXXXXXXX	
RoHS Compliant	

PRECAUTIONS

1. The lead pitch of the LED must match the pitch of the mounting holes on the PCB during component placement. Lead-forming may be required to insure the lead pitch matches the hole pitch. Refer to the figure below for proper lead forming procedures. (Fig. 1)

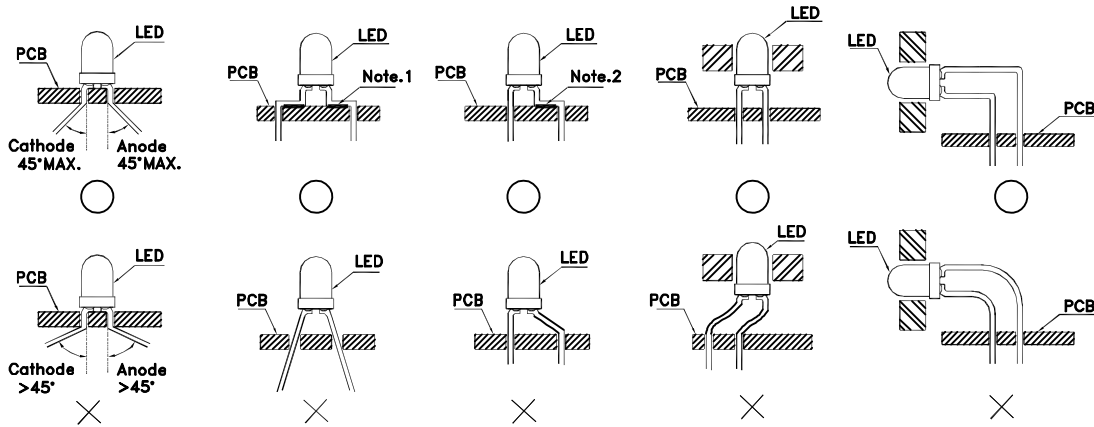

Fig.1

”○” Correct mounting method ”×” Incorrect mounting method

2. When soldering wire to the LED, use individual heat-shrink tubing to insulate the exposed leads to prevent accidental contact short-circuit. (Fig.2)

3. Use stand-offs (Fig.3) or spacers (Fig.4) to securely position the LED above the PCB.

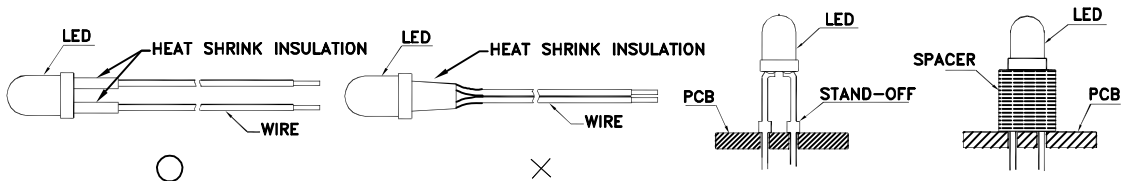

Fig. 2

Fig. 3

Fig. 4

4. Maintain a minimum of 2mm clearance between the base of the LED lens and the first lead bend. (Fig. 5 and 6)
5. During lead forming, use tools or jigs to hold the leads securely so that the bending force will not be transmitted to the LED lens and its internal structures. Do not perform lead forming once the component has been mounted onto the PCB. (Fig. 7)

6. Do not bend the leads more than twice. (Fig. 8)

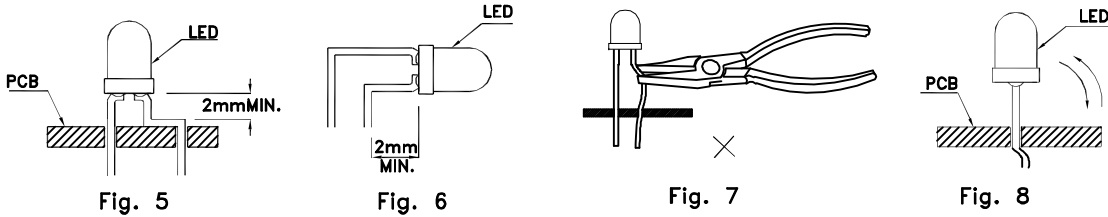

7. During soldering, component covers and holders should leave clearance to avoid placing damaging stress on the LED during soldering.

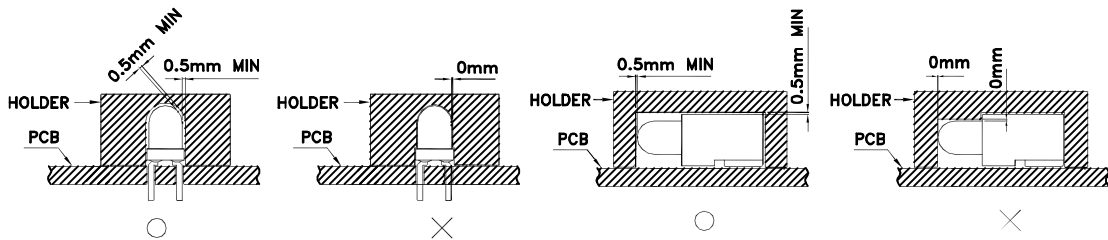

8. The tip of the soldering iron should never touch the lens epoxy.

9. Through-hole LEDs are incompatible with reflow soldering.

10. If the LED will undergo multiple soldering passes or face other processes where the part may be subjected to intense heat, please check with Kingbright for compatibility.

11. Recommended Wave Soldering Profile for Kingbright Thru-Hole Products

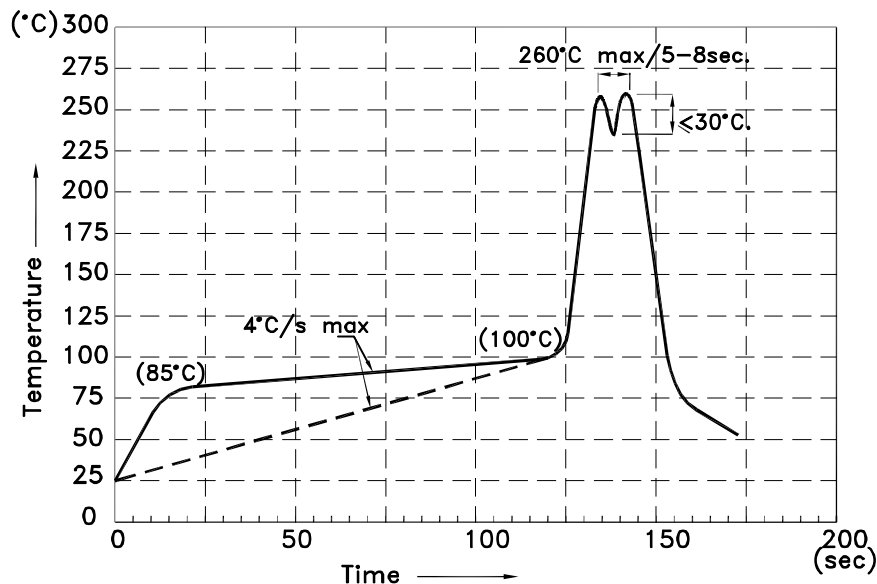

Notes:

1. Recommend the solder wave peak temperature kept between 245~260°C, The maximum soldering temperature should not exceed 260°C.
2. Do not apply stress to the epoxy body while the temperature is above 85°C.
3. During the wave soldering process, the preheat temperature must not exceed 100°C.
4. Fixtures should not place stress on the component when mounted.
5. No more than one soldering pass.