

1

2

3

4

5

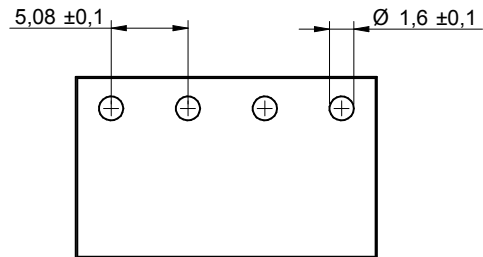
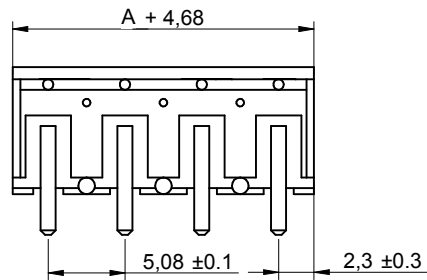

PCB LAYOUT

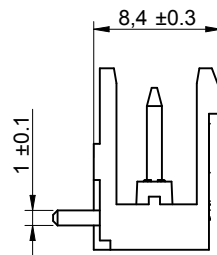
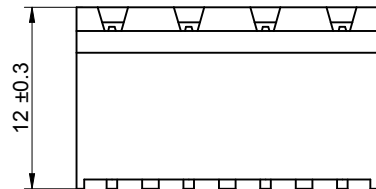

Poles	A
2	5.08
3	10.16
4	15.24
5	20.32
6	25.40
7	30.48
8	35.56
9	40.64
10	45.72
11	50.80
12	55.88

CHARACTERISTICS

MATERIAL

Insulator material : LCP
 Flammability rating : UL94-V0
 Colour : Black
 Contact pin : Brass (CuZn)
 Surface of solder tail plating : Tin Plated

ENVIRONMENTAL

Operating temperature : -40°C up to 105°C
 Compliance : Lead free and RoHS

SOLDERING

Solder temperature : Reflow process as per JEDEC J-020D-STD

ELECTRICAL

Current rating : 10A
 Working voltage : 300 Vac
 Dielectric withstanding voltage : 4 kVac/min
 Contact resistance : 20 mΩ max

STANDARD

 us Certified : E315414 / Model number 7015



MECHANICAL

Pitch : 5.08mm

PACKAGING

Tape & Reel

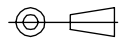
RoHS Compliant

G				PROJECTION: 	GENERAL TOLERANCE .X = ± 0.2 .XX = ± 0.15	 WÜRTH ELEKTRONIK	DESCRIPTION: SERIE 7015B - 5.08MM OPEN HORIZONTAL PCB HEADER - THR TYPE	SIZE A4
F								
E								
D								
C				APPROVAL: RJ	UNIT: MM	WERI PART NO: 691 701 530 0xx B		
B	19-DEC-11	6917015300xx	QL		SCALE: 2/1			
A	14-SEP-11	PDF	QL		SHEET: 1/2			
REV	DATE	FILE	BY		DRAW: QUENTIN			

1

2

3

4

5

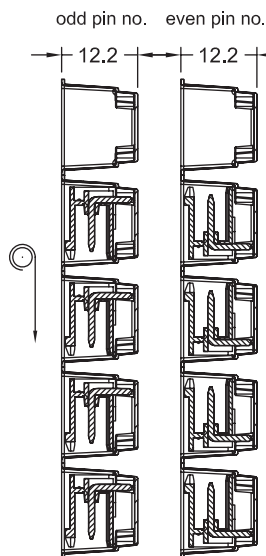
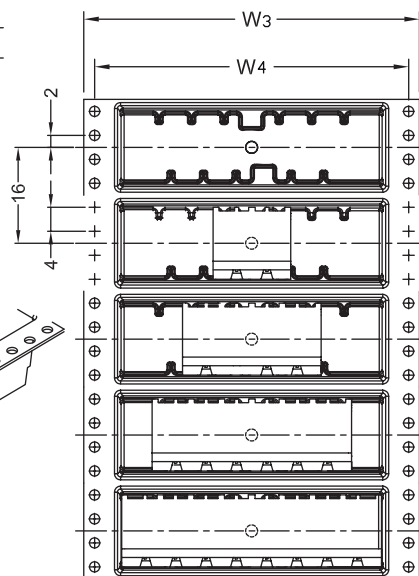
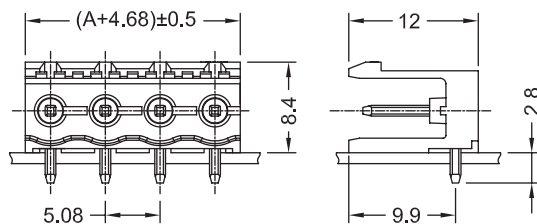
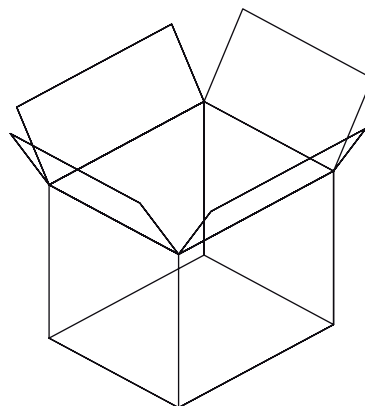
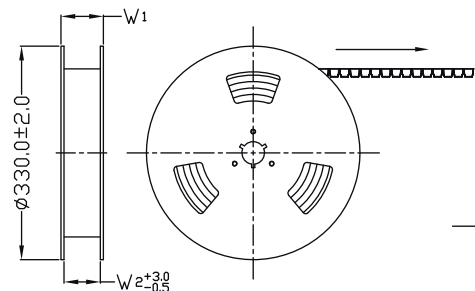

1. 10 sprocket hole pitch cumulative tolerance ± 0.20
2. Carrier camber is within 1 mm in 250 mm.
3. Material : Black Conductive Polystyrene Alloy.
Transparent anti-static PET
4. All dimensions meet EIA-481-C requirements.
5. Thickness : 0.50 ± 0.05 mm.
6. Component load per 13" reel : 250 pcs.

Poles	A	Dimension				Packing (Reel/cotton)	Carton dimensions (cm)	Quantity / Carton
		W1(mm)	W2(mm)	W3(mm)	W4(mm)			
2	5.08	36.4	32	32	28.4	10	33.5 x 33.5 x 40	2500
3	10.16	36.4	32	32	28.4	10	33.5 x 33.5 x 40	2500
4	15.24	36.4	32	32	28.4	10	33.5 x 33.5 x 40	2500
5	20.32	60.4	56	56	52.4	6	33.5 x 33.5 x 40	1500
6	25.40	60.4	56	56	52.4	6	33.5 x 33.5 x 40	1500
7	30.48	60.4	56	56	52.4	6	33.5 x 33.5 x 40	1500
8	35.56	60.4	56	56	52.4	6	33.5 x 33.5 x 40	1500
9	40.64	92.4	88	88	84.4	4	33.5 x 33.5 x 40	1000
10	45.72	92.4	88	88	84.4	4	33.5 x 33.5 x 40	1000
11	50.80	92.4	88	88	84.4	4	33.5 x 33.5 x 40	1000
12	55.88	92.4	88	88	84.4	4	33.5 x 33.5 x 40	1000

RoHS Compliant

PROJECTION:

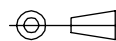

GENERAL TOLERANCE

.X = ± 0.2 .XX = ± 0.15 

APPROVAL: RJ

UNIT: MM

SCALE:

SHEET: 2/2

DRAW: QUENTIN

DESCRIPTION: SERIE 7015B - 5.08MM OPEN HORIZONTAL PCB HEADER - THR TYPE

WERI PART NO: 691 701 530 0xx B

SIZE

A4

G			
F			
E			
D			
C			
B			
A			
REV	DATE	FILE	BY