

BL/SL 3.50 series
BL 3.50/16/90 SN BK BX
Weidmüller Interface GmbH & Co. KG

Klingenbergstraße 16

D-32758 Detmold

Germany

Fon: +49 5231 14-0

Fax: +49 5231 14-2083

www.weidmueller.com

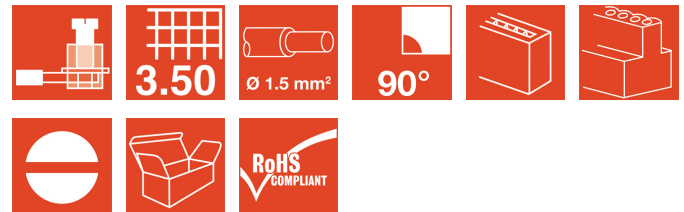

Female connectors with clamping yoke screw system for connecting conductors at 3.50 mm pitch. They include space for labelling and can be coded.

- 0.20 - 1.5 mm² (IEC) / 28 - 14 AWG (UL)
- 250 V (IEC) / 300 V (UL)
- 17 A (IEC) / 10 A (UL)

General ordering data

Order No.	1638920000
Type	BL 3.50/16/90 SN BK BX
Version	PCB plug-in connector, female plug, 3.50 mm, No. of poles: 16, 90°, Clamping yoke connection, Clamping range, rated connection, max.: 1.5 mm ² , Box
Product data	IEC: 320 V / 12 A / 0.2 - 1.5 mm ² UL: 300 V / 8 A / AWG 28 - AWG 14
GTIN (EAN)	4008190276461
Qty.	50 pc(s).
Packaging	Box

Creation date March 13, 2012 1:02:11 PM CET

BL/SL 3.50 series
BL 3.50/16/90 SN BK BX

Weidmüller Interface GmbH & Co. KG
 Klingenbergstraße 16
 D-32758 Detmold
 Germany
 Fon: +49 5231 14-0
 Fax: +49 5231 14-2083
 www.weidmueller.com

Technical data**System parameters**

Product family	BL/SL 3.50 series	Conductor connection system	Clamping yoke connection
Outgoing direction of conductor	90°	Pitch in mm (P)	3.5 mm
Pitch in inches (P)	0.138 inch	No. of poles	16
Number of rows	1	Screwdriver blade	0.4 x 2.5
Screwdriver blade standard	DIN 5264	Tightening torque, min.	0.2 Nm
Tightening torque, max.	0.25 Nm	Clamping screw	M 2
Stripping length	6 mm	L1 in mm	52.5 mm
L1 in inches	2.067 inch	Touch-safe protection acc. to DIN VDE 0470 IP 20	
Touch-safe protection acc. to DIN VDE 57 106	Safe from finger touch		

Material data

Insulating material	PBT	Colour	Black
Colour chart	Similar to RAL 9011	Flammability class UL 94	V-0
CTI	≥ 200	Contact material	Copper alloy
Contact surface	tinned	Continuous operating temp., min.	-25 °C
Continuous operating temp., max.	100 °C		

Connectable conductors

Clamping range, rated connection, min.	0.08 mm ²	Clamping range, rated connection, max.	1.5 mm ²
Wire connection cross section AWG, min.	AWG 14	Wire connection cross section AWG, max.	AWG 28
Solid, min. H05(07) V-U	0.2 mm ²	Solid, max. H05(07) V-U	1.5 mm ²
Flexible, min. H05(07) V-K	0.2 mm ²	Flexible, max. H05(07) V-K	1.5 mm ²
w. wire end ferrule, DIN 46228 pt 1, min.	0.2 mm ²	w. wire end ferrule, DIN 46228 pt 1, max.	1.5 mm ²
w. plastic collar ferrule, DIN 46228 pt 4, min.	0.2 mm ²	w. plastic collar ferrule, DIN 46228 pt 4, max.	1.5 mm ²
Plug gauge acc. to EN 60999 a x b; ø	2.4 mm x 1.5 mm		

DIN IEC rating data

Rated current, min. no. of poles (Tu=20°C)	12 A	Rated current, max. no. of poles (Tu=20°C)	10 A
Rated current, number of poles (Tu=40°C), min.	10 A	Rated current, number of poles (Tu=40°C), max.	8 A
Rated voltage for surge voltage class / pollution degree II/2	320 V	Rated voltage for surge voltage class / pollution degree III/2	160 V
Rated voltage for surge voltage class / pollution degree III/3	160 V	Rated impulse voltage for surge voltage class/ pollution degree II/2	2.5 kV
Rated impulse voltage for surge voltage class/ pollution degree III/2	2.5 kV	Rated impulse voltage for surge voltage class/ contamination degree III/3	2.5 kV
Short-time withstand current resistance	3 x 1s with 100 A		

CSA rating data

Institute (CSA)		Rated voltage (Use group B)	300 V
Rated current (use group B)	10 A	Rated voltage (use group D)	300 V
Rated current (use group D)	10 A	Wire cross-section, AWG, min.	AWG 28
Wire cross-section, AWG, max.	AWG 14		

**BL/SL 3.50 series
BL 3.50/16/90 SN BK BX**

Weidmüller Interface GmbH & Co. KG
Klingenbergstraße 16
D-32758 Detmold
Germany
Fon: +49 5231 14-0
Fax: +49 5231 14-2083
www.weidmueller.com

Technical data

UL 1059 rating data

Rated voltage (use group B)	300 V	Rated current (use group B)	8 A
Rated voltage (use group D)	300 V	Rated current (use group D)	8 A
Wire cross-section, AWG, min.	AWG 28	Wire cross-section, AWG, max.	AWG 14

Classifications

ETIM 3.0	EC001284	ETIM 4.0	EC002637
UNSPSC	30-21-18-10	eClass 4.1	27-26-07-01
eClass 5.1	27-26-07-04	eClass 6.0	27-26-07-04
eClass 7.0	27-44-04-02		

Notes

- Notes
- Additional colours on request
 - Gold-plated contact surfaces on request
 - Rated current related to rated cross-section and min. No. of poles.
 - Max. O.D. of conductor: 2.9 mm
 - Wire end ferrule without plastic collar to DIN 46228/1
 - Wire end ferrule with plastic collar to DIN 46228/4
 - P on drg. = pitch
 - Rated data refer only to the component itself. Clearance and creepage distances to other components are to be designed in accordance with the relevant application standards.

Approvals

Approvals



**BL/SL 3.50 series
BL 3.50/16/90 SN BK BX**

Weidmüller Interface GmbH & Co. KG
Klingenbergstraße 16
D-32758 Detmold
Germany
Fon: +49 5231 14-0
Fax: +49 5231 14-2083
www.weidmueller.com

Drawings

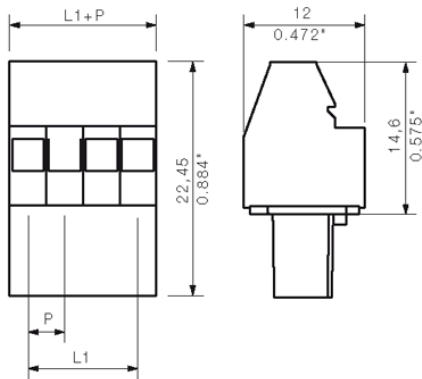

BL 3.50/..90 & /270 - SL 3.50/..90

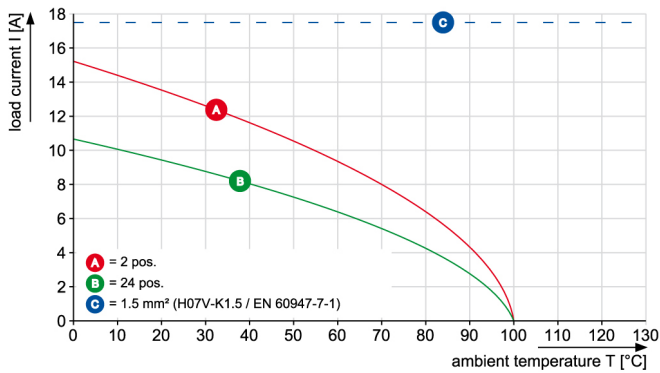

BL 3.50/..90 & /270 - SL 3.50/..90

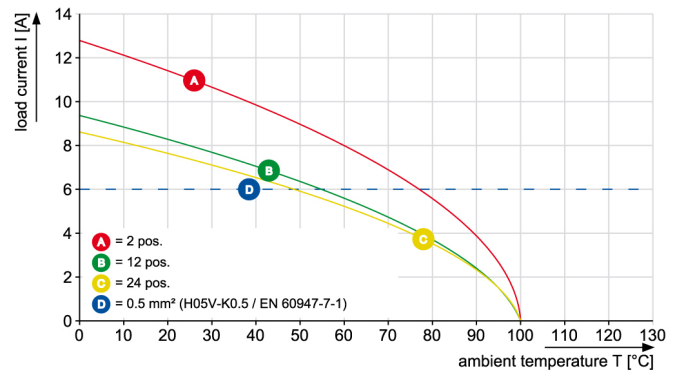

BL/SL 3.50 series
BL 3.50/16/90 SN BK BX

Weidmüller Interface GmbH & Co. KG
 Klingenbergstraße 16
 D-32758 Detmold
 Germany
 Fon: +49 5231 14-0
 Fax: +49 5231 14-2083
 www.weidmueller.com

Mating connector (fully pluggable)

SLD 3.5V/180G

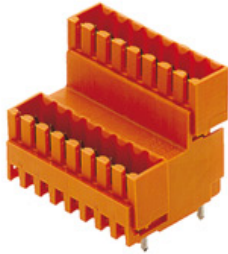

Two-tier offset male connector for wave soldering, with 3.50 mm pitch The male connector is available in closed and flange versions. The male connectors provide space for labelling and can be coded.

- 250 V (IEC) / 300 V (UL)
- 10.5 A (IEC) / 8 A (UL)

General ordering data

Order No.	Type	Version	Product data	GTIN (EAN)	Qty.	Packaging
1641180000	SLD 3.5 V/32/180G 3.2OR	PCB plug-in connector, male header, closed side, Solder connection, 3.50 mm, No. of poles: 32, 180°, Solder pin length (l): 3.2 mm, tinned, Orange, Box	IEC: 200 V / 10.5 A UL: 300 V / 8 A	4008190279585	10 pc(s).	Box

SLD 3.5/90

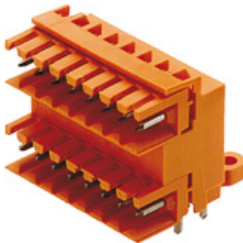

Two-tier male connector for wave soldering, with 3.50 mm pitch The male connector is available in open, closed and flange versions. The male connectors provide space for labelling and can be coded. Packed in cardboard box.

- 250 V (IEC) / 300 V (UL)
- 10.5 A (IEC) / 8 A (UL)

General ordering data

Order No.	Type	Version	Product data	GTIN (EAN)	Qty.	Packaging
1633490000	SLD 3.50/32/90 3.2SN OR BX	PCB plug-in connector, male header, open side, Solder connection, 3.50 mm, No. of poles: 32, 90°, Solder pin length (l): 3.2 mm, tinned, Orange, Box	IEC: 200 V / 10.5 A UL: 300 V / 8 A	4008190257941	10 pc(s).	Box

BL/SL 3.50 series
BL 3.50/16/90 SN BK BX

Weidmüller Interface GmbH & Co. KG
 Klingenbergstraße 16
 D-32758 Detmold
 Germany
 Fon: +49 5231 14-0
 Fax: +49 5231 14-2083
 www.weidmueller.com

Mating connector (fully pluggable)

SLD 3.5V/90G



Two-tier offset male connector for wave soldering, with 3.50 mm pitch. The male connector is available in closed and flange versions. The male connectors provide space for labelling and can be coded.

- 250 V (IEC) / 300 V (UL)
- 10.5 A (IEC) / 8 A (UL)

General ordering data

Order No.	Type	Version	Product data	GTIN (EAN)	Qty.	Packaging
1642310000	SLD 3.50 V/32/90G 3.2 SN OR BX	PCB plug-in connector, male header, closed side, Solder connection, 3.50 mm, No. of poles: 32, 90°, Solder pin length (l): 3.2 mm, tinned, Orange, Box	IEC: 200 V / 10.5 A UL: 300 V / 8 A	4008190280833	10 pc(s).	Box

SL 3.5/90

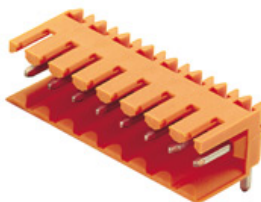

Male connector with 3.50 mm pitch for wave soldering. The male connector is available in open, closed and flange versions. The male connectors provide space for labelling and can be coded. Packed in cardboard box.

- 250 V (IEC) / 300 V (UL)
- 17 A (IEC) / 10 A (UL)

General ordering data

Order No.	Type	Version	Product data	GTIN (EAN)	Qty.	Packaging
1597350000	SL 3.50/16/90 3.2SN OR BX	PCB plug-in connector, male header, open side, Solder connection, 3.50 mm, No. of poles: 16, 90°, Solder pin length (l): 3.2 mm, tinned, Orange, Box	IEC: 320 V / 17 A UL: 300 V / 10 A	4008190105594	50 pc(s).	Box

BL/SL 3.50 series
BL 3.50/16/90 SN BK BX

Weidmüller Interface GmbH & Co. KG
 Klingenbergstraße 16
 D-32758 Detmold
 Germany
 Fon: +49 5231 14-0
 Fax: +49 5231 14-2083
 www.weidmueller.com

Mating connector (fully pluggable)

SLD 3.5/90G

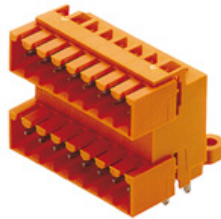

Two-tier male connector for wave soldering, with 3.50 mm pitch The male connector is available in open, closed and flange versions. The male connectors provide space for labelling and can be coded. Packed in cardboard box.

- 250 V (IEC) / 300 V (UL)
- 10.5 A (IEC) / 8 A (UL)

General ordering data

Order No.	Type	Version	Product data	GTIN (EAN)	Qty.	Packaging
1633720000	SLD 3.50/32/90G 3.2SN OR BX	PCB plug-in connector, male header, closed side, Solder connection, 3.50 mm, No. of poles: 32, 90°, Solder pin length (l): 3.2 mm, tinned, Orange, Box	IEC: 200 V / 10.5 A UL: 300 V / 8 A	4008190258177	10 pc(s).	Box

SL 3.5/180G

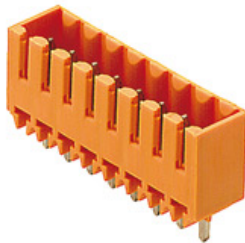

Male connector with 3.50 mm pitch for wave soldering The male connector is available in open, closed and flange versions. The male connectors provide space for labelling and can be coded. Packed in cardboard box.

- 250 V (IEC) / 300 V (UL)
- 17 A (IEC) / 10 A (UL)

General ordering data

Order No.	Type	Version	Product data	GTIN (EAN)	Qty.	Packaging
1604610000	SL 3.50/16/180G 3.2SN OR BX	PCB plug-in connector, male header, closed side, Solder connection, 3.50 mm, No. of poles: 16, 180°, Solder pin length (l): 3.2 mm, tinned, Orange, Box	IEC: 320 V / 17 A UL: 300 V / 10 A	4008190112615	50 pc(s).	Box

**BL/SL 3.50 series
BL 3.50/16/90 SN BK BX**

Weidmüller Interface GmbH & Co. KG
Klingenbergstraße 16
D-32758 Detmold
Germany
Fon: +49 5231 14-0
Fax: +49 5231 14-2083
www.weidmueller.com

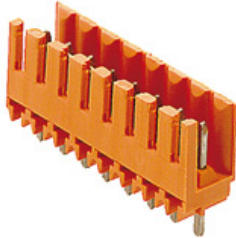
Mating connector (fully pluggable)
SL 3.5/180

Male connector with 3.50 mm pitch for wave soldering The male connector is available in open, closed and flange versions. The male connectors provide space for labelling and can be coded. Packed in cardboard box.

- 250 V (IEC) / 300 V (UL)
- 17 A (IEC) / 10 A (UL)

General ordering data

Order No.	Type	Version	Product data	GTIN (EAN)	Qty.	Packaging
1604910000	SL 3.50/16/180 3.2SN OR BX	PCB plug-in connector, male header, open side, Solder connection, 3.50 mm, No. of poles: 16, 180°, Solder pin length (l): 3.2 mm, tinned, Orange, Box	IEC: 320 V / 17 A UL: 300 V / 10 A	4008190034023	50 pc(s).	Box

SL-THR 3.5/135F

High-temperature-resistant male connector with 3.50 mm pitch for all customary soldering methods. Optimised for automatic assembly. Packed in box or tape. 3.2 mm solder pin suitable for reflow and wave soldering. These male connectors have space for labelling and can be coded.

- 250 V (IEC) / 300 V (UL)
- 15 A (IEC) / 10 A (UL)

General ordering data

Order No.	Type	Version	Product data	GTIN (EAN)	Qty.	Packaging
1003660000	SL-SMT 3.50/16/135F 3.2SN BK BX	PCB plug-in connector, male header, Flange, Reflow solder connection, 3.50 mm, No. of poles: 16, 135°, Solder pin length (l): 3.2 mm, tinned, Box	IEC: 320 V / 15 A UL: 300 V / 10 A	4032248700288	50 pc(s).	Box

**BL/SL 3.50 series
BL 3.50/16/90 SN BK BX**

Weidmüller Interface GmbH & Co. KG
 Klingenbergstraße 16
 D-32758 Detmold
 Germany
 Fon: +49 5231 14-0
 Fax: +49 5231 14-2083
 www.weidmueller.com

Mating connector (fully pluggable)
SL-SMT 3.5/90G Box

High-temperature-resistant male connector with 3.50 mm pitch for all customary soldering methods. Optimised for automatic assembly. Packed in box or tape. 3.2 mm solder pin suitable for reflow and wave soldering. These male connectors have space for labelling and can be coded.

- 250 V (IEC) / 300 V (UL)
- 15 A (IEC) / 10 A (UL)

General ordering data

Order No.	Type	Version	Product data	GTIN (EAN)	Qty.	Packaging
1841770000	SL-SMT 3.50/16/90G 3.2SN BK BX	PCB plug-in connector, male header, closed side, Reflow solder connection, 3.50 mm, No. of poles: 16, 90°, Solder pin length (l): 3.2 mm, tinned, Black, Box	IEC: 320 V / 15 A UL: 300 V / 10 A	4032248353125	50 pc(s).	Box
1761682001	SL-SMT 3.50/16/90G 1.5SN BK BX	PCB plug-in connector, male header, closed side, Reflow solder connection, 3.50 mm, No. of poles: 16, 90°, Solder pin length (l): 1.5 mm, tinned, Black, Box	IEC: 320 V / 15 A UL: 300 V / 10 A	4032248132270	50 pc(s).	Box

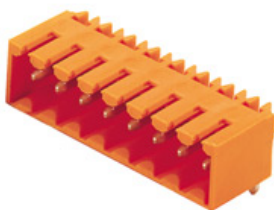
SL 3.5/90G

Male connector with 3.50 mm pitch for wave soldering The male connector is available in open, closed and flange versions. The male connectors provide space for labelling and can be coded. Packed in cardboard box.

- 250 V (IEC) / 300 V (UL)
- 17 A (IEC) / 10 A (UL)

General ordering data

Order No.	Type	Version	Product data	GTIN (EAN)	Qty.	Packaging
1605210000	SL 3.50/16/90G 3.2SN OR BX	PCB plug-in connector, male header, closed side, Solder connection, 3.50 mm, No. of poles: 16, 90°, Solder pin length (l): 3.2 mm, tinned, Orange, Box	IEC: 320 V / 17 A UL: 300 V / 10 A	4008190129255	50 pc(s).	Box

**BL/SL 3.50 series
BL 3.50/16/90 SN BK BX**

Weidmüller Interface GmbH & Co. KG
 Klingenbergstraße 16
 D-32758 Detmold
 Germany
 Fon: +49 5231 14-0
 Fax: +49 5231 14-2083
 www.weidmueller.com

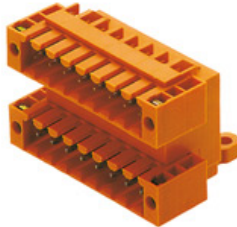
Mating connector (conditionally pluggable)
SLD 3.5/90F

Two-tier male connector for wave soldering, with 3.50 mm pitch. The male connector is available in open, closed and flange versions. The male connectors provide space for labelling and can be coded. Packed in cardboard box.

- 250 V (IEC) / 300 V (UL)
- 10.5 A (IEC) / 8 A (UL)

General ordering data

Order No.	Type	Version	Product data	GTIN (EAN)	Qty.	Packaging
1633950000	SLD 3.50/32/90F 3.2SN OR BX	PCB plug-in connector, male header, Flange, Solder connection, 3.50 mm, No. of poles: 32, 90°, Solder pin length (l): 3.2 mm, tinned, Orange, Box	IEC: 200 V / 10.5 A UL: 300 V / 8 A	4008190258405	10 pc(s).	Box

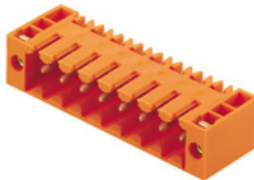
SL 3.5/90F

Male connector with 3.50 mm pitch for wave soldering. The male connector is available in open, closed and flange versions. The male connectors provide space for labelling and can be coded. Packed in cardboard box.

- 250 V (IEC) / 300 V (UL)
- 17 A (IEC) / 10 A (UL)

General ordering data

Order No.	Type	Version	Product data	GTIN (EAN)	Qty.	Packaging
1607180000	SL 3.50/16/90F 3.2SN OR BX	PCB plug-in connector, male header, Flange, Solder connection, 3.50 mm, No. of poles: 16, 90°, Solder pin length (l): 3.2 mm, tinned, Orange, Box	IEC: 320 V / 17 A UL: 300 V / 10 A	4008190004446	50 pc(s).	Box

**BL/SL 3.50 series
BL 3.50/16/90 SN BK BX**

Weidmüller Interface GmbH & Co. KG
Klingenbergstraße 16
D-32758 Detmold
Germany
Fon: +49 5231 14-0
Fax: +49 5231 14-2083
www.weidmueller.com

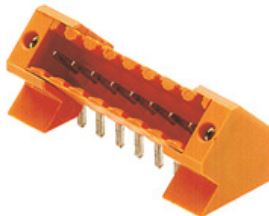
Mating connector (conditionally pluggable)
SL 3.5/135F

Male connector with 3.50 mm pitch for wave soldering The male connector is available in open, closed and flange versions. The male connectors provide space for labelling and can be coded. Packed in cardboard box.

- 250 V (IEC) / 300 V (UL)
- 17 A (IEC) / 10 A (UL)

General ordering data

Order No.	Type	Version	Product data	GTIN (EAN)	Qty.	Packaging
1643470000	SL 3.50/16/135F 3.2SN OR BX	PCB plug-in connector, male header, Flange, Solder connection, 3.50 mm, No. of poles: 16, 135°, Solder pin length (l): 3.2 mm, tinned, Orange, Box	IEC: 320 V / 15 A UL: 300 V / 10 A	4008190282233	50 pc(s).	Box

SLD 3.5V/90F

Two-tier offset male connector for wave soldering, with 3.50 mm pitch The male connector is available in closed and flange versions. The male connectors provide space for labelling and can be coded.

- 250 V (IEC) / 300 V (UL)
- 10.5 A (IEC) / 8 A (UL)

General ordering data

Order No.	Type	Version	Product data	GTIN (EAN)	Qty.	Packaging
1642440000	SLD 3.50 V/32/90F 3.2 SN OR BX	PCB plug-in connector, male header, Flange, Solder connection, 3.50 mm, No. of poles: 32, 90°, Solder pin length (l): 3.2 mm, tinned, Orange, Box	IEC: 200 V / 10.5 A UL: 300 V / 8 A	4008190280963	10 pc(s).	Box

**BL/SL 3.50 series
BL 3.50/16/90 SN BK BX**

Weidmüller Interface GmbH & Co. KG
 Klingenbergstraße 16
 D-32758 Detmold
 Germany
 Fon: +49 5231 14-0
 Fax: +49 5231 14-2083
 www.weidmueller.com

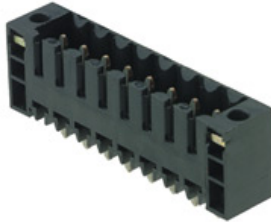
Mating connector (conditionally pluggable)
SL-SMT 3.5/180F Box

High-temperature-resistant male connector with 3.50 mm pitch for all customary soldering methods. Optimised for automatic assembly. Packed in box or tape. 3.2 mm solder pin suitable for reflow and wave soldering. These male connectors have space for labelling and can be coded.

- 250 V (IEC) / 300 V (UL)
- 15 A (IEC) / 10 A (UL)

General ordering data

Order No.	Type	Version	Product data	GTIN (EAN)	Qty.	Packaging
1842910000	SL-SMT 3.50/16/180F 3.2SN BK BX	PCB plug-in connector, male header, Flange, Reflow solder connection, 3.50 mm, No. of poles: 16, 180°, Solder pin length (l): 3.2 mm, tinned, Box	IEC: 320 V / 15 A UL: 300 V / 10 A	4032248354375	50 pc(s).	Box

SL-SMT 3.5/90LF Box

High-temperature-resistant male connector with 3.50 mm pitch for all customary soldering methods. Optimised for automatic assembly. Packed in box or tape. 3.2 mm solder pin suitable for reflow and wave soldering. These male connectors have space for labelling and can be coded.

- 250 V (IEC) / 300 V (UL)
- 15 A (IEC) / 10 A (UL)

General ordering data

Order No.	Type	Version	Product data	GTIN (EAN)	Qty.	Packaging
1841990000	SL-SMT 3.50/16/90LF 3.2SN BK BX	PCB plug-in connector, male header, Solder flange, Reflow solder connection, 3.50 mm, No. of poles: 16, 90°, Solder pin length (l): 3.2 mm, tinned, Box	IEC: 320 V / 15 A UL: 300 V / 10 A	4032248353347	50 pc(s).	Box
1805080000	SL-SMT 3.50/16/90LF 1.5SN BK BX	PCB plug-in connector, male header, Solder flange, Reflow solder connection, 3.50 mm, No. of poles: 16, 90°, Solder pin length (l): 1.5 mm, tinned, Box	IEC: 320 V / 15 A UL: 300 V / 10 A	4032248268986	50 pc(s).	Box

**BL/SL 3.50 series
BL 3.50/16/90 SN BK BX**

Weidmüller Interface GmbH & Co. KG
 Klingenbergstraße 16
 D-32758 Detmold
 Germany
 Fon: +49 5231 14-0
 Fax: +49 5231 14-2083
 www.weidmueller.com

Mating connector (conditionally pluggable)
SL-SMT 3.5/90F Box

High-temperature-resistant male connector with 3.50 mm pitch for all customary soldering methods. Optimised for automatic assembly. Packed in box or tape. 3.2 mm solder pin suitable for reflow and wave soldering. These male connectors have space for labelling and can be coded.

- 250 V (IEC) / 300 V (UL)
- 15 A (IEC) / 10 A (UL)

General ordering data

Order No.	Type	Version	Product data	GTIN (EAN)	Qty.	Packaging
1842220000	SL-SMT 3.50/16/90F 3.2SN BK BX	PCB plug-in connector, male header, Flange, Reflow solder connection, 3.50 mm, No. of poles: 16, 90°, Solder pin length (l): 3.2 mm, tinned, Box	IEC: 320 V / 15 A UL: 300 V / 10 A	4032248353576	50 pc(s).	Box

SL-SMT 3.5/180G Box

High-temperature-resistant male connector with 3.50 mm pitch for all customary soldering methods. Optimised for automatic assembly. Packed in box or tape. 3.2 mm solder pin suitable for reflow and wave soldering. These male connectors have space for labelling and can be coded.

- 250 V (IEC) / 300 V (UL)
- 15 A (IEC) / 10 A (UL)

General ordering data

Order No.	Type	Version	Product data	GTIN (EAN)	Qty.	Packaging
1842450000	SL-SMT 3.50/16/180G 3.2SN BK BX	PCB plug-in connector, male header, closed side, Reflow solder connection, 3.50 mm, No. of poles: 16, 180°, Solder pin length (l): 3.2 mm, tinned, Black, Box	IEC: 320 V / 15 A UL: 300 V / 10 A	4032248353804	50 pc(s).	Box
1753122001	SL-SMT 3.50/16/180G 1.5SN BK BX	PCB plug-in connector, male header, closed side, Reflow solder connection, 3.50 mm, No. of poles: 16, 180°, Solder pin length (l): 1.5 mm, tinned, Black, Box	IEC: 320 V / 15 A UL: 300 V / 10 A	4032248131020	50 pc(s).	Box

**BL/SL 3.50 series
BL 3.50/16/90 SN BK BX**

Weidmüller Interface GmbH & Co. KG
 Klingenbergstraße 16
 D-32758 Detmold
 Germany
 Fon: +49 5231 14-0
 Fax: +49 5231 14-2083
 www.weidmueller.com

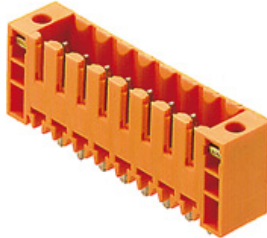
Mating connector (conditionally pluggable)
SL 3.5/180F

Male connector with 3.50 mm pitch for wave soldering The male connector is available in open, closed and flange versions. The male connectors provide space for labelling and can be coded. Packed in cardboard box.

- 250 V (IEC) / 300 V (UL)
- 17 A (IEC) / 10 A (UL)

General ordering data

Order No.	Type	Version	Product data	GTIN (EAN)	Qty.	Packaging
1607640000	SL 3.50/16/180F 3.2SN OR BX	PCB plug-in connector, male header, Flange, Solder connection, 3.50 mm, No. of poles: 16, 180°, Solder pin length (l): 3.2 mm, tinned, Orange, Box	IEC: 320 V / 17 A UL: 300 V / 10 A	4008190034535	50 pc(s).	Box

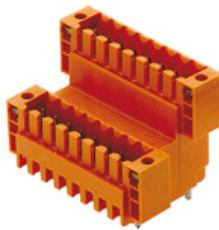
SLD 3.5V/180F

Two-tier offset male connector for wave soldering, with 3.50 mm pitch The male connector is available in closed and flange versions. The male connectors provide space for labelling and can be coded.

- 250 V (IEC) / 300 V (UL)
- 10.5 A (IEC) / 8 A (UL)

General ordering data

Order No.	Type	Version	Product data	GTIN (EAN)	Qty.	Packaging
1641310000	SLD 3.50 V/32/180F 3.2 SN OR BX	PCB plug-in connector, male header, Flange, Solder connection, 3.50 mm, No. of poles: 32, 180°, Solder pin length (l): 3.2 mm, tinned, Orange, Box	IEC: 200 V / 10.5 A UL: 300 V / 8 A	4008190279714	10 pc(s).	Box

**BL/SL 3.50 series
BL 3.50/16/90 SN BK BX**

Weidmüller Interface GmbH & Co. KG
Klingenbergstraße 16
D-32758 Detmold
Germany
Fon: +49 5231 14-0
Fax: +49 5231 14-2083
www.weidmueller.com

Mating connector (conditionally pluggable)

SL-SMT 3.5/180LF Box



High-temperature-resistant male connector with 3.50 mm pitch for all customary soldering methods. Optimised for automatic assembly. Packed in box or tape. 3.2 mm solder pin suitable for reflow and wave soldering. These male connectors have space for labelling and can be coded.

- 250 V (IEC) / 300 V (UL)
- 15 A (IEC) / 10 A (UL)

General ordering data

Order No.	Type	Version	Product data	GTIN (EAN)	Qty.	Packaging
1842680000	SL-SMT 3.50/16/180LF 3.2SN BK BX	PCB plug-in connector, male header, Solder flange, Reflow solder connection, 3.50 mm, No. of poles: 16, 180°, Solder pin length (l): 3.2 mm, tinned, Box	IEC: 320 V / 15 A UL: 300 V / 10 A	4032248354047	50 pc(s).	Box
1804840000	SL-SMT 3.50/16/180LF 1.5SN BK BX	PCB plug-in connector, male header, Solder flange, Reflow solder connection, 3.50 mm, No. of poles: 16, 180°, Solder pin length (l): 1.5 mm, tinned, Box	IEC: 320 V / 15 A UL: 300 V / 10 A	4032248268610	50 pc(s).	Box

