

BL/SL 3.50 series
BL 3.50/04/90 SN BK BX

Weidmüller Interface GmbH & Co. KG

Klingenbergstraße 16

D-32758 Detmold

Germany

Fon: +49 5231 14-0

Fax: +49 5231 14-2083

www.weidmueller.com

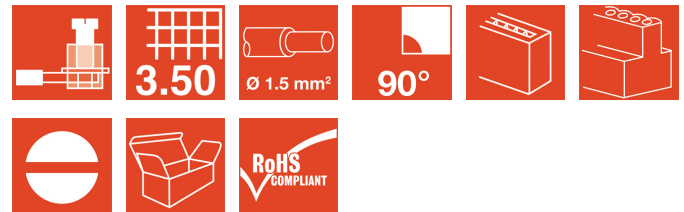

Female connectors with clamping yoke screw system for connecting conductors at 3.50 mm pitch. They include space for labelling and can be coded.

- 0.20 - 1.5 mm² (IEC) / 28 - 14 AWG (UL)
- 250 V (IEC) / 300 V (UL)
- 17 A (IEC) / 10 A (UL)

General ordering data

Order No.	1638800000
Type	BL 3.50/04/90 SN BK BX
Version	PCB plug-in connector, female plug, 3.50 mm, No. of poles: 4, 90°, Clamping yoke connection, Clamping range, rated connection, max.: 1.5 mm ² , Box
Product data	IEC: 320 V / 12 A / 0.2 - 1.5 mm ² UL: 300 V / 8 A / AWG 28 - AWG 14
GTIN (EAN)	4008190276348
Qty.	100 pc(s).
Packaging	Box

Creation date March 13, 2012 1:04:43 PM CET

BL/SL 3.50 series
BL 3.50/04/90 SN BK BX

Weidmüller Interface GmbH & Co. KG
 Klingenbergstraße 16
 D-32758 Detmold
 Germany
 Fon: +49 5231 14-0
 Fax: +49 5231 14-2083
 www.weidmueller.com

Technical data**System parameters**

Product family	BL/SL 3.50 series	Conductor connection system	Clamping yoke connection
Outgoing direction of conductor	90°	Pitch in mm (P)	3.5 mm
Pitch in inches (P)	0.138 inch	No. of poles	4
Number of rows	1	Screwdriver blade	0.4 x 2.5
Screwdriver blade standard	DIN 5264	Tightening torque, min.	0.2 Nm
Tightening torque, max.	0.25 Nm	Clamping screw	M 2
Stripping length	6 mm	L1 in mm	10.5 mm
L1 in inches	0.413 inch	Touch-safe protection acc. to DIN VDE 0470 IP 20	
Touch-safe protection acc. to DIN VDE 57 106	Safe from finger touch		

Material data

Insulating material	PBT	Colour	Black
Colour chart	Similar to RAL 9011	Flammability class UL 94	V-0
CTI	≥ 200	Contact material	Copper alloy
Contact surface	tinned	Continuous operating temp., min.	-25 °C
Continuous operating temp., max.	100 °C		

Connectable conductors

Clamping range, rated connection, min.	0.08 mm ²	Clamping range, rated connection, max.	1.5 mm ²
Wire connection cross section AWG, min.	AWG 14	Wire connection cross section AWG, max.	AWG 28
Solid, min. H05(07) V-U	0.2 mm ²	Solid, max. H05(07) V-U	1.5 mm ²
Flexible, min. H05(07) V-K	0.2 mm ²	Flexible, max. H05(07) V-K	1.5 mm ²
w. wire end ferrule, DIN 46228 pt 1, min.	0.2 mm ²	w. wire end ferrule, DIN 46228 pt 1, max.	1.5 mm ²
w. plastic collar ferrule, DIN 46228 pt 4, min.	0.2 mm ²	w. plastic collar ferrule, DIN 46228 pt 4, max.	1.5 mm ²
Plug gauge acc. to EN 60999 a x b; ø	2.4 mm x 1.5 mm		

DIN IEC rating data

Rated current, min. no. of poles (Tu=20°C)	12 A	Rated current, max. no. of poles (Tu=20°C)	10 A
Rated current, number of poles (Tu=40°C), min.	10 A	Rated current, number of poles (Tu=40°C), max.	8 A
Rated voltage for surge voltage class / pollution degree II/2	320 V	Rated voltage for surge voltage class / pollution degree III/2	160 V
Rated voltage for surge voltage class / pollution degree III/3	160 V	Rated impulse voltage for surge voltage class/ pollution degree II/2	2.5 kV
Rated impulse voltage for surge voltage class/ pollution degree III/2	2.5 kV	Rated impulse voltage for surge voltage class/ contamination degree III/3	2.5 kV
Short-time withstand current resistance	3 x 1s with 100 A		

CSA rating data

Institute (CSA)		Rated voltage (Use group B)	300 V
Rated current (use group B)	10 A	Rated voltage (use group D)	300 V
Rated current (use group D)	10 A	Wire cross-section, AWG, min.	AWG 28
Wire cross-section, AWG, max.	AWG 14		

**BL/SL 3.50 series
BL 3.50/04/90 SN BK BX**

Weidmüller Interface GmbH & Co. KG
 Klingenbergstraße 16
 D-32758 Detmold
 Germany
 Fon: +49 5231 14-0
 Fax: +49 5231 14-2083
 www.weidmueller.com

Technical data
UL 1059 rating data

Rated voltage (use group B)	300 V	Rated current (use group B)	8 A
Rated voltage (use group D)	300 V	Rated current (use group D)	8 A
Wire cross-section, AWG, min.	AWG 28	Wire cross-section, AWG, max.	AWG 14

Classifications

ETIM 3.0	EC001284	ETIM 4.0	EC002637
UNSPSC	30-21-18-10	eClass 4.1	27-26-07-01
eClass 5.1	27-26-07-04	eClass 6.0	27-26-07-04
eClass 7.0	27-44-04-02		

Notes

- Notes
- Additional colours on request
 - Gold-plated contact surfaces on request
 - Rated current related to rated cross-section and min. No. of poles.
 - Max. O.D. of conductor: 2.9 mm
 - Wire end ferrule without plastic collar to DIN 46228/1
 - Wire end ferrule with plastic collar to DIN 46228/4
 - P on drg. = pitch
 - Rated data refer only to the component itself. Clearance and creepage distances to other components are to be designed in accordance with the relevant application standards.

Approvals

Approvals



**BL/SL 3.50 series
BL 3.50/04/90 SN BK BX**

Weidmüller Interface GmbH & Co. KG
Klingenbergstraße 16
D-32758 Detmold
Germany
Fon: +49 5231 14-0
Fax: +49 5231 14-2083
www.weidmueller.com

Drawings

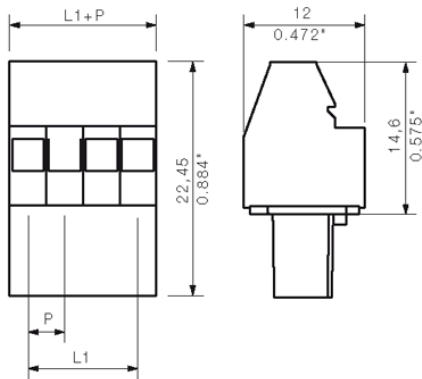

BL 3.50/..90 & /270 - SL 3.50/..90

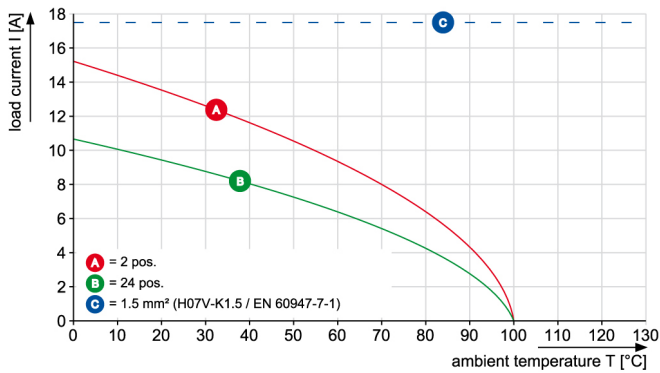

BL 3.50/..90 & /270 - SL 3.50/..90

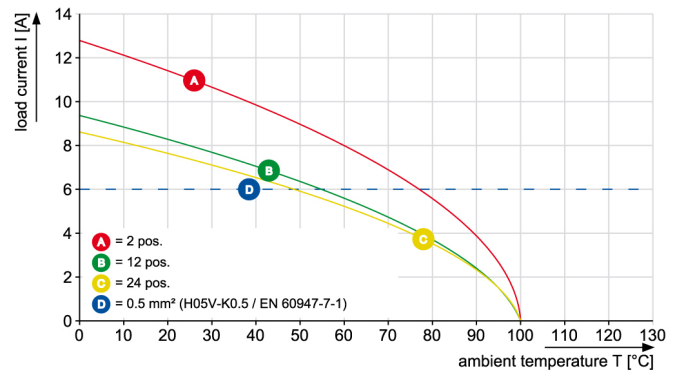

**BL/SL 3.50 series
BL 3.50/04/90 SN BK BX**

Weidmüller Interface GmbH & Co. KG
 Klingenbergstraße 16
 D-32758 Detmold
 Germany
 Fon: +49 5231 14-0
 Fax: +49 5231 14-2083
 www.weidmueller.com

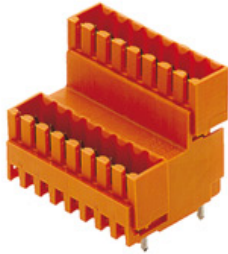
Mating connector (fully pluggable)
SLD 3.5V/180G

Two-tier offset male connector for wave soldering, with 3.50 mm pitch The male connector is available in closed and flange versions. The male connectors provide space for labelling and can be coded.

- 250 V (IEC) / 300 V (UL)
- 10.5 A (IEC) / 8 A (UL)

General ordering data

Order No.	Type	Version	Product data	GTIN (EAN)	Qty.	Packaging
1641120000	SLD 3.5 V/8/180G 3.2OR	PCB plug-in connector, male header, closed side, Solder connection, 3.50 mm, No. of poles: 8, 180°, Solder pin length (l): 3.2 mm, tinned, Orange, Box	IEC: 200 V / 10.5 A UL: 300 V / 8 A	4008190279523	50 pc(s).	Box

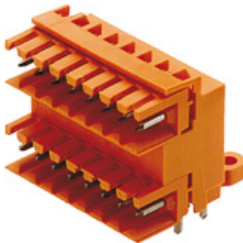
SLD 3.5/90

Two-tier male connector for wave soldering, with 3.50 mm pitch The male connector is available in open, closed and flange versions. The male connectors provide space for labelling and can be coded. Packed in cardboard box.

- 250 V (IEC) / 300 V (UL)
- 10.5 A (IEC) / 8 A (UL)

General ordering data

Order No.	Type	Version	Product data	GTIN (EAN)	Qty.	Packaging
1633370000	SLD 3.50/08/90 3.2SN OR BX	PCB plug-in connector, male header, open side, Solder connection, 3.50 mm, No. of poles: 8, 90°, Solder pin length (l): 3.2 mm, tinned, Orange, Box	IEC: 200 V / 10.5 A UL: 300 V / 8 A	4008190257828	50 pc(s).	Box

**BL/SL 3.50 series
BL 3.50/04/90 SN BK BX**

Weidmüller Interface GmbH & Co. KG
 Klingenbergstraße 16
 D-32758 Detmold
 Germany
 Fon: +49 5231 14-0
 Fax: +49 5231 14-2083
 www.weidmueller.com

Mating connector (fully pluggable)
SLD 3.5V/90G

Two-tier offset male connector for wave soldering, with 3.50 mm pitch. The male connector is available in closed and flange versions. The male connectors provide space for labelling and can be coded.

- 250 V (IEC) / 300 V (UL)
- 10.5 A (IEC) / 8 A (UL)

General ordering data

Order No.	Type	Version	Product data	GTIN (EAN)	Qty.	Packaging
1642250000	SLD 3.50 V/08/90G 3.2 SN OR BX	PCB plug-in connector, male header, closed side, Solder connection, 3.50 mm, No. of poles: 8, 90°, Solder pin length (l): 3.2 mm, tinned, Orange, Box	IEC: 200 V / 10.5 A UL: 300 V / 8 A	4008190280772	50 pc(s).	Box

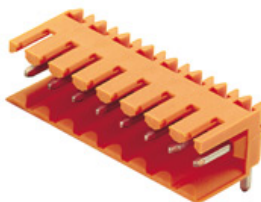
SL 3.5/90

Male connector with 3.50 mm pitch for wave soldering. The male connector is available in open, closed and flange versions. The male connectors provide space for labelling and can be coded. Packed in cardboard box.

- 250 V (IEC) / 300 V (UL)
- 17 A (IEC) / 10 A (UL)

General ordering data

Order No.	Type	Version	Product data	GTIN (EAN)	Qty.	Packaging
1597230000	SL 3.50/04/90 3.2SN OR BX	PCB plug-in connector, male header, open side, Solder connection, 3.50 mm, No. of poles: 4, 90°, Solder pin length (l): 3.2 mm, tinned, Orange, Box	IEC: 320 V / 17 A UL: 300 V / 10 A	4008190029838	100 pc(s).	Box

**BL/SL 3.50 series
BL 3.50/04/90 SN BK BX**

Weidmüller Interface GmbH & Co. KG
 Klingenbergstraße 16
 D-32758 Detmold
 Germany
 Fon: +49 5231 14-0
 Fax: +49 5231 14-2083
 www.weidmueller.com

Mating connector (fully pluggable)
SL-SMT 3.5/90G Tape

High-temperature-resistant male connector with 3.50 mm pitch for all customary soldering methods. Optimised for automatic assembly. Packed in box or tape. 3.2 mm solder pin suitable for reflow and wave soldering. These male connectors have space for labelling and can be coded.

- 250 V (IEC) / 300 V (UL)
- 15 A (IEC) / 10 A (UL)

General ordering data

Order No.	Type	Version	Product data	GTIN (EAN)	Qty.	Packaging
1761564002	SL-SMT 3.50/04/90G 1.5SN BK RL	PCB plug-in connector, male header, closed side, Reflow solder connection, 3.50 mm, No. of poles: 4, 90°, Solder pin length (l): 1.5 mm, tinned, Black, Tape	IEC: 320 V / 15 A UL: 300 V / 10 A	4032248193349	385 pc(s).	Tape

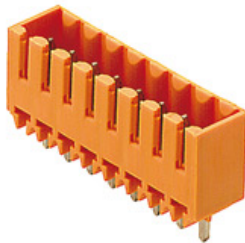
SL 3.5/180G

Male connector with 3.50 mm pitch for wave soldering The male connector is available in open, closed and flange versions. The male connectors provide space for labelling and can be coded. Packed in cardboard box.

- 250 V (IEC) / 300 V (UL)
- 17 A (IEC) / 10 A (UL)

General ordering data

Order No.	Type	Version	Product data	GTIN (EAN)	Qty.	Packaging
1604490000	SL 3.50/04/180G 3.2SN OR BX	PCB plug-in connector, male header, closed side, Solder connection, 3.50 mm, No. of poles: 4, 180°, Solder pin length (l): 3.2 mm, tinned, Orange, Box	IEC: 320 V / 17 A UL: 300 V / 10 A	4008190115852	100 pc(s).	Box

**BL/SL 3.50 series
BL 3.50/04/90 SN BK BX**

Weidmüller Interface GmbH & Co. KG
Klingenbergstraße 16
D-32758 Detmold
Germany
Fon: +49 5231 14-0
Fax: +49 5231 14-2083
www.weidmueller.com

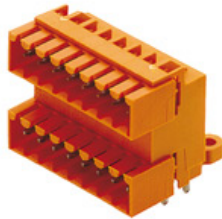
Mating connector (fully pluggable)
SLD 3.5/90G

Two-tier male connector for wave soldering, with 3.50 mm pitch The male connector is available in open, closed and flange versions. The male connectors provide space for labelling and can be coded. Packed in cardboard box.

- 250 V (IEC) / 300 V (UL)
- 10.5 A (IEC) / 8 A (UL)

General ordering data

Order No.	Type	Version	Product data	GTIN (EAN)	Qty.	Packaging
1633600000	SLD 3.50/08/90G 3.2SN OR BX	PCB plug-in connector, male header, closed side, Solder connection, 3.50 mm, No. of poles: 8, 90°, Solder pin length (l): 3.2 mm, tinned, Orange, Box	IEC: 200 V / 10.5 A UL: 300 V / 8 A	4008190258054	50 pc(s).	Box

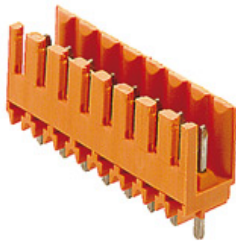
SL 3.5/180

Male connector with 3.50 mm pitch for wave soldering The male connector is available in open, closed and flange versions. The male connectors provide space for labelling and can be coded. Packed in cardboard box.

- 250 V (IEC) / 300 V (UL)
- 17 A (IEC) / 10 A (UL)

General ordering data

Order No.	Type	Version	Product data	GTIN (EAN)	Qty.	Packaging
1604790000	SL 3.50/04/180 3.2SN OR BX	PCB plug-in connector, male header, open side, Solder connection, 3.50 mm, No. of poles: 4, 180°, Solder pin length (l): 3.2 mm, tinned, Orange, Box	IEC: 320 V / 17 A UL: 300 V / 10 A	4008190127855	100 pc(s).	Box

**BL/SL 3.50 series
BL 3.50/04/90 SN BK BX**

Weidmüller Interface GmbH & Co. KG
 Klingenbergstraße 16
 D-32758 Detmold
 Germany
 Fon: +49 5231 14-0
 Fax: +49 5231 14-2083
 www.weidmueller.com

Mating connector (fully pluggable)
SL-THR 3.5/135F

High-temperature-resistant male connector with 3.50 mm pitch for all customary soldering methods. Optimised for automatic assembly. Packed in box or tape. 3.2 mm solder pin suitable for reflow and wave soldering. These male connectors have space for labelling and can be coded.

- 250 V (IEC) / 300 V (UL)
- 15 A (IEC) / 10 A (UL)

General ordering data

Order No.	Type	Version	Product data	GTIN (EAN)	Qty.	Packaging
1003530000	SL-SMT 3.50/04/135F 3.2SN BK BX	PCB plug-in connector, male header, Flange, Reflow solder connection, 3.50 mm, No. of poles: 4, 135°, Solder pin length (l): 3.2 mm, tinned, Box	IEC: 320 V / 15 A UL: 300 V / 10 A	4032248700165	100 pc(s).	Box

SL-SMT 3.5/90G Box

High-temperature-resistant male connector with 3.50 mm pitch for all customary soldering methods. Optimised for automatic assembly. Packed in box or tape. 3.2 mm solder pin suitable for reflow and wave soldering. These male connectors have space for labelling and can be coded.

- 250 V (IEC) / 300 V (UL)
- 15 A (IEC) / 10 A (UL)

General ordering data

Order No.	Type	Version	Product data	GTIN (EAN)	Qty.	Packaging
1761562001	SL-SMT 3.50/04/90G 1.5SN BK BX	PCB plug-in connector, male header, closed side, Reflow solder connection, 3.50 mm, No. of poles: 4, 90°, Solder pin length (l): 1.5 mm, tinned, Black, Box	IEC: 320 V / 15 A UL: 300 V / 10 A	4032248132058	100 pc(s).	Box
1841650000	SL-SMT 3.50/04/90G 3.2SN BK BX	PCB plug-in connector, male header, closed side, Reflow solder connection, 3.50 mm, No. of poles: 4, 90°, Solder pin length (l): 3.2 mm, tinned, Black, Box	IEC: 320 V / 15 A UL: 300 V / 10 A	4032248352807	100 pc(s).	Box

BL/SL 3.50 series
BL 3.50/04/90 SN BK BX

Weidmüller Interface GmbH & Co. KG
 Klingenbergstraße 16
 D-32758 Detmold
 Germany
 Fon: +49 5231 14-0
 Fax: +49 5231 14-2083
 www.weidmueller.com

Mating connector (fully pluggable)

SL-SMT 3.5/180G Tape



High-temperature-resistant male connector with 3.50 mm pitch for all customary soldering methods. Optimised for automatic assembly. Packed in box or tape. 3.2 mm solder pin suitable for reflow and wave soldering. These male connectors have space for labelling and can be coded.

- 250 V (IEC) / 300 V (UL)
- 15 A (IEC) / 10 A (UL)

General ordering data

Order No.	Type	Version	Product data	GTIN (EAN)	Qty.	Packaging
1753004002	SL-SMT 3.50/04/180G 1.5SN BK RL	PCB plug-in connector, male header, closed side, Reflow solder connection, 3.50 mm, No. of poles: 4, 180°, Solder pin length (l): 1.5 mm, tinned, Black, Tape	IEC: 320 V / 15 A UL: 300 V / 10 A	4032248193219	265 pc(s).	Tape

SL 3.5/90G

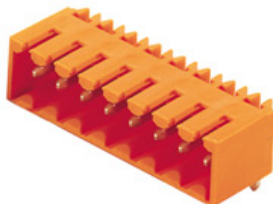

Male connector with 3.50 mm pitch for wave soldering The male connector is available in open, closed and flange versions. The male connectors provide space for labelling and can be coded. Packed in cardboard box.

- 250 V (IEC) / 300 V (UL)
- 17 A (IEC) / 10 A (UL)

General ordering data

Order No.	Type	Version	Product data	GTIN (EAN)	Qty.	Packaging
1605090000	SL 3.50/04/90G 3.2SN OR BX	PCB plug-in connector, male header, closed side, Solder connection, 3.50 mm, No. of poles: 4, 90°, Solder pin length (l): 3.2 mm, tinned, Orange, Box	IEC: 320 V / 17 A UL: 300 V / 10 A	4008190054304	100 pc(s).	Box

BL/SL 3.50 series
BL 3.50/04/90 SN BK BX

Weidmüller Interface GmbH & Co. KG
 Klingenbergstraße 16
 D-32758 Detmold
 Germany
 Fon: +49 5231 14-0
 Fax: +49 5231 14-2083
 www.weidmueller.com

Mating connector (conditionally pluggable)

SLD 3.5/90F

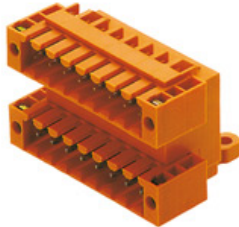

Two-tier male connector for wave soldering, with 3.50 mm pitch. The male connector is available in open, closed and flange versions. The male connectors provide space for labelling and can be coded. Packed in cardboard box.

- 250 V (IEC) / 300 V (UL)
- 10.5 A (IEC) / 8 A (UL)

General ordering data

Order No.	Type	Version	Product data	GTIN (EAN)	Qty.	Packaging
1633830000	SLD 3.50/08/90F 3.2SN OR BX	PCB plug-in connector, male header, Flange, Solder connection, 3.50 mm, No. of poles: 8, 90°, Solder pin length (l): 3.2 mm, tinned, Orange, Box	IEC: 200 V / 10.5 A UL: 300 V / 8 A	4008190258283	50 pc(s).	Box

SL 3.5/90F

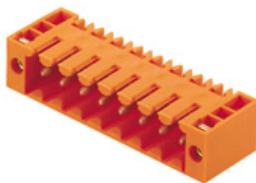

Male connector with 3.50 mm pitch for wave soldering. The male connector is available in open, closed and flange versions. The male connectors provide space for labelling and can be coded. Packed in cardboard box.

- 250 V (IEC) / 300 V (UL)
- 17 A (IEC) / 10 A (UL)

General ordering data

Order No.	Type	Version	Product data	GTIN (EAN)	Qty.	Packaging
1607060000	SL 3.50/04/90F 3.2SN OR BX	PCB plug-in connector, male header, Flange, Solder connection, 3.50 mm, No. of poles: 4, 90°, Solder pin length (l): 3.2 mm, tinned, Orange, Box	IEC: 320 V / 17 A UL: 300 V / 10 A	4008190131661	100 pc(s).	Box

**BL/SL 3.50 series
BL 3.50/04/90 SN BK BX**

Weidmüller Interface GmbH & Co. KG
 Klingenbergstraße 16
 D-32758 Detmold
 Germany
 Fon: +49 5231 14-0
 Fax: +49 5231 14-2083
 www.weidmueller.com

Mating connector (conditionally pluggable)
SL-SMT 3.5/180F Box

High-temperature-resistant male connector with 3.50 mm pitch for all customary soldering methods. Optimised for automatic assembly. Packed in box or tape. 3.2 mm solder pin suitable for reflow and wave soldering. These male connectors have space for labelling and can be coded.

- 250 V (IEC) / 300 V (UL)
- 15 A (IEC) / 10 A (UL)

General ordering data

Order No.	Type	Version	Product data	GTIN (EAN)	Qty.	Packaging
1842790000	SL-SMT 3.50/04/180F 3.2SN BK BX	PCB plug-in connector, male header, Flange, Reflow solder connection, 3.50 mm, No. of poles: 4, 180°, Solder pin length (l): 3.2 mm, tinned, Box	IEC: 320 V / 15 A UL: 300 V / 10 A	4032248354153	100 pc(s).	Box
1760982001	SL-SMT 3.50/04/180F 1.5SN BK BX	PCB plug-in connector, male header, Flange, Reflow solder connection, 3.50 mm, No. of poles: 4, 180°, Solder pin length (l): 1.5 mm, tinned, Box	IEC: 320 V / 15 A UL: 300 V / 10 A	4032248131556	100 pc(s).	Box

SL-SMT 3.5/90F Box

High-temperature-resistant male connector with 3.50 mm pitch for all customary soldering methods. Optimised for automatic assembly. Packed in box or tape. 3.2 mm solder pin suitable for reflow and wave soldering. These male connectors have space for labelling and can be coded.

- 250 V (IEC) / 300 V (UL)
- 15 A (IEC) / 10 A (UL)

General ordering data

Order No.	Type	Version	Product data	GTIN (EAN)	Qty.	Packaging
1842100000	SL-SMT 3.50/04/90F 3.2SN BK BX	PCB plug-in connector, male header, Flange, Reflow solder connection, 3.50 mm, No. of poles: 4, 90°, Solder pin length (l): 3.2 mm, tinned, Box	IEC: 320 V / 15 A UL: 300 V / 10 A	4032248353453	100 pc(s).	Box

**BL/SL 3.50 series
BL 3.50/04/90 SN BK BX**

Weidmüller Interface GmbH & Co. KG
 Klingenbergstraße 16
 D-32758 Detmold
 Germany
 Fon: +49 5231 14-0
 Fax: +49 5231 14-2083
 www.weidmueller.com

Mating connector (conditionally pluggable)
SL-SMT 3.5/180LF Tape

High-temperature-resistant male connector with 3.50 mm pitch for all customary soldering methods. Optimised for automatic assembly. Packed in box or tape. 3.2 mm solder pin suitable for reflow and wave soldering. These male connectors have space for labelling and can be coded.

- 250 V (IEC) / 300 V (UL)
- 15 A (IEC) / 10 A (UL)

General ordering data

Order No.	Type	Version	Product data	GTIN (EAN)	Qty.	Packaging
1805240000	SL-SMT 3.50/04/180LF 1.5SN BK RL	PCB plug-in connector, male header, Solder flange, Reflow solder connection, 3.50 mm, No. of poles: 4, 180°, Solder pin length (l): 1.5 mm, tinned, Black, Tape	IEC: 320 V / 15 A UL: 300 V / 10 A	4032248269518	265 pc(s).	Tape

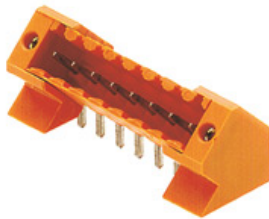
SL 3.5/135F

Male connector with 3.50 mm pitch for wave soldering The male connector is available in open, closed and flange versions. The male connectors provide space for labelling and can be coded. Packed in cardboard box.

- 250 V (IEC) / 300 V (UL)
- 17 A (IEC) / 10 A (UL)

General ordering data

Order No.	Type	Version	Product data	GTIN (EAN)	Qty.	Packaging
1643350000	SL 3.50/04/135F 3.2SN OR BX	PCB plug-in connector, male header, Flange, Solder connection, 3.50 mm, No. of poles: 4, 135°, Solder pin length (l): 3.2 mm, tinned, Orange, Box	IEC: 320 V / 15 A UL: 300 V / 10 A	4008190282110	100 pc(s).	Box

BL/SL 3.50 series
BL 3.50/04/90 SN BK BX

Weidmüller Interface GmbH & Co. KG
 Klingenbergstraße 16
 D-32758 Detmold
 Germany
 Fon: +49 5231 14-0
 Fax: +49 5231 14-2083
 www.weidmueller.com

Mating connector (conditionally pluggable)
SLD 3.5V/90F

Two-tier offset male connector for wave soldering, with 3.50 mm pitch. The male connector is available in closed and flange versions. The male connectors provide space for labelling and can be coded.

- 250 V (IEC) / 300 V (UL)
- 10.5 A (IEC) / 8 A (UL)

General ordering data

Order No.	Type	Version	Product data	GTIN (EAN)	Qty.	Packaging
1642380000	SLD 3.50 V/08/90F 3.2 SN OR BX	PCB plug-in connector, male header, Flange, Solder connection, 3.50 mm, No. of poles: 8, 90°, Solder pin length (l): 3.2 mm, tinned, Orange, Box	IEC: 200 V / 10.5 A UL: 300 V / 8 A	4008190280901	50 pc(s).	Box

SL-SMT 3.5/90LF Box

High-temperature-resistant male connector with 3.50 mm pitch for all customary soldering methods. Optimised for automatic assembly. Packed in box or tape. 3.2 mm solder pin suitable for reflow and wave soldering. These male connectors have space for labelling and can be coded.

- 250 V (IEC) / 300 V (UL)
- 15 A (IEC) / 10 A (UL)

General ordering data

Order No.	Type	Version	Product data	GTIN (EAN)	Qty.	Packaging
1804960000	SL-SMT 3.50/04/90LF 1.5SN BK BX	PCB plug-in connector, male header, Solder flange, Reflow solder connection, 3.50 mm, No. of poles: 4, 90°, Solder pin length (l): 1.5 mm, tinned, Box	IEC: 320 V / 15 A UL: 300 V / 10 A	4032248268863	100 pc(s).	Box
1841880000	SL-SMT 3.50/04/90LF 3.2SN BK BX	PCB plug-in connector, male header, Solder flange, Reflow solder connection, 3.50 mm, No. of poles: 4, 90°, Solder pin length (l): 3.2 mm, tinned, Box	IEC: 320 V / 15 A UL: 300 V / 10 A	4032248353231	100 pc(s).	Box

**BL/SL 3.50 series
BL 3.50/04/90 SN BK BX**

Weidmüller Interface GmbH & Co. KG
 Klingenbergstraße 16
 D-32758 Detmold
 Germany
 Fon: +49 5231 14-0
 Fax: +49 5231 14-2083
 www.weidmueller.com

Mating connector (conditionally pluggable)
SL-SMT 3.5/180G Box

High-temperature-resistant male connector with 3.50 mm pitch for all customary soldering methods. Optimised for automatic assembly. Packed in box or tape. 3.2 mm solder pin suitable for reflow and wave soldering. These male connectors have space for labelling and can be coded.

- 250 V (IEC) / 300 V (UL)
- 15 A (IEC) / 10 A (UL)

General ordering data

Order No.	Type	Version	Product data	GTIN (EAN)	Qty.	Packaging
1842340000	SL-SMT 3.50/04/180G 3.2SN BK BX	PCB plug-in connector, male header, closed side, Reflow solder connection, 3.50 mm, No. of poles: 4, 180°, Solder pin length (l): 3.2 mm, tinned, Black, Box	IEC: 320 V / 15 A UL: 300 V / 10 A	4032248353682	100 pc(s).	Box
1753002001	SL-SMT 3.50/04/180G 1.5SN BK BX	PCB plug-in connector, male header, closed side, Reflow solder connection, 3.50 mm, No. of poles: 4, 180°, Solder pin length (l): 1.5 mm, tinned, Black, Box	IEC: 320 V / 15 A UL: 300 V / 10 A	4032248130894	100 pc(s).	Box

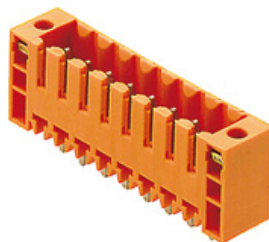
SL 3.5/180F

Male connector with 3.50 mm pitch for wave soldering The male connector is available in open, closed and flange versions. The male connectors provide space for labelling and can be coded. Packed in cardboard box.

- 250 V (IEC) / 300 V (UL)
- 17 A (IEC) / 10 A (UL)

General ordering data

Order No.	Type	Version	Product data	GTIN (EAN)	Qty.	Packaging
1607520000	SL 3.50/04/180F 3.2SN OR BX	PCB plug-in connector, male header, Flange, Solder connection, 3.50 mm, No. of poles: 4, 180°, Solder pin length (l): 3.2 mm, tinned, Orange, Box	IEC: 320 V / 17 A UL: 300 V / 10 A	4008190039097	100 pc(s).	Box

**BL/SL 3.50 series
BL 3.50/04/90 SN BK BX**

Weidmüller Interface GmbH & Co. KG
Klingenbergstraße 16
D-32758 Detmold
Germany
Fon: +49 5231 14-0
Fax: +49 5231 14-2083
www.weidmueller.com

Mating connector (conditionally pluggable)
SL-SMT 3.5/90LF Tape

High-temperature-resistant male connector with 3.50 mm pitch for all customary soldering methods. Optimised for automatic assembly. Packed in box or tape. 3.2 mm solder pin suitable for reflow and wave soldering. These male connectors have space for labelling and can be coded.

- 250 V (IEC) / 300 V (UL)
- 15 A (IEC) / 10 A (UL)

General ordering data

Order No.	Type	Version	Product data	GTIN (EAN)	Qty.	Packaging
1805330000	SL-SMT 3.50/04/90LF 1.5SN BK RL	PCB plug-in connector, male header, Solder flange, Reflow solder connection, 3.50 mm, No. of poles: 4, 90°, Solder pin length (l): 1.5 mm, tinned, Tape	IEC: 320 V / 15 A UL: 300 V / 10 A	4032248269587	385 pc(s).	Tape

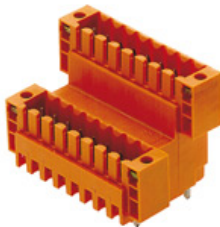
SLD 3.5V/180F

Two-tier offset male connector for wave soldering, with 3.50 mm pitch The male connector is available in closed and flange versions. The male connectors provide space for labelling and can be coded.

- 250 V (IEC) / 300 V (UL)
- 10.5 A (IEC) / 8 A (UL)

General ordering data

Order No.	Type	Version	Product data	GTIN (EAN)	Qty.	Packaging
1641250000	SLD 3.50 V/08/180F 3.2 SN OR BX	PCB plug-in connector, male header, Flange, Solder connection, 3.50 mm, No. of poles: 8, 180°, Solder pin length (l): 3.2 mm, tinned, Orange, Box	IEC: 200 V / 10.5 A UL: 300 V / 8 A	4008190279653	50 pc(s).	Box

**BL/SL 3.50 series
BL 3.50/04/90 SN BK BX**

Weidmüller Interface GmbH & Co. KG
Klingenbergstraße 16
D-32758 Detmold
Germany
Fon: +49 5231 14-0
Fax: +49 5231 14-2083
www.weidmueller.com

Mating connector (conditionally pluggable)

SL-SMT 3.5/180LF Box



High-temperature-resistant male connector with 3.50 mm pitch for all customary soldering methods. Optimised for automatic assembly. Packed in box or tape. 3.2 mm solder pin suitable for reflow and wave soldering. These male connectors have space for labelling and can be coded.

- 250 V (IEC) / 300 V (UL)
- 15 A (IEC) / 10 A (UL)

General ordering data

Order No.	Type	Version	Product data	GTIN (EAN)	Qty.	Packaging
1842560000	SL-SMT 3.50/04/180LF 3.2SN BK BX	PCB plug-in connector, male header, Solder flange, Reflow solder connection, 3.50 mm, No. of poles: 4, 180°, Solder pin length (l): 3.2 mm, tinned, Box	IEC: 320 V / 15 A UL: 300 V / 10 A	4032248353927	100 pc(s).	Box
1804720000	SL-SMT 3.50/04/180LF 1.5SN BK BX	PCB plug-in connector, male header, Solder flange, Reflow solder connection, 3.50 mm, No. of poles: 4, 180°, Solder pin length (l): 1.5 mm, tinned, Box	IEC: 320 V / 15 A UL: 300 V / 10 A	4032248268702	100 pc(s).	Box

