

VALU-BEAM[®] SMA912 Series

3-wire ac self-contained sensors with solid-state outputs

BANNER[®]

the photoelectric specialist

- Sensors with 3-wire hookup for 24 to 130V ac
- All sensing modes available: opposed, retroreflective, diffuse (proximity), convergent, and fiberoptic
- Switch selectable for light- or dark-operate
- Totally encapsulated circuitry in a rugged, molded plastic housing; NEMA 1, 2, 3, 3S, 4, 4X, 12, and 13
- Integral conduit fitting and 6' PVC-covered cable supplied on standard models; NEMA-4 *minifast*[™] Quick Disconnect cable/connector combination optional
- Adjustable sensitivity
- Versatile mounting options

Banner SMA912 Series VALU-BEAMs are rugged, self-contained photoelectric sensors designed for especially demanding industrial applications where economy, performance, and durability are important.

SMA912 Series VALU-BEAMs have solid state outputs and operate from 24 to 130V ac (50/60 Hz). Hookup is three-wire. NOTE: Emitters operate from either 24 to 130V ac or 10 to 30V dc.

Powerful modulated LED light sources give SMA912 Series VALU-BEAM sensors greater sensing range than competitive units and a high degree of immunity to ambient light. All models are totally epoxy-encapsulated and housed in molded VALOX[®] housings for the ultimate in shock, vibration, moisture, and corrosion resistance. All VALU-BEAM sensors conform to NEMA standards 1, 2, 3, 3S, 4, 4X, 12, and 13.

The output of VALU-BEAM SMA912 Series three-wire ac sensors is a solid-state switch capable of 500 mA (60VA) continuous load (5 amps inrush). See hookup diagrams, page 2.

SMA912 Series VALU-BEAM sensors have an easily-visible top-mounted red LED indicator to assist in alignment and system monitoring. SMA912 series sensors have Banner's exclusive, patented* AID[™] system (Alignment Indicating Device), which lights the indicator LED whenever the sensor "sees" its modulated light source, and also pulses the LED at a rate proportional to the received light signal strength. This feature greatly simplifies alignment: in most situations, alignment becomes simply a matter of positioning the sensor for maximum LED pulse rate. Emitters

*US patent #4356393



have a visible red "tracer beam" that indicates "power on" and enables easy "line-of-sight" alignment.

SMA912 Series sensors offer a choice of light or dark operate in the same sensor, switched via a convenient rear panel control.

SMA912 Series sensors may be mounted from either the front or the rear using their two through-mounting holes, or by the outside threads of their base (mounting nut supplied), making them ideal for conveyor and other production line applications. A selection of mounting brackets is available (page 2). The bases of standard VALU-BEAMs have a 1/2" NPS integral internal conduit thread, and are supplied with a 6-foot PVC-covered cable. Models with a NEMA 4-rated quick-disconnect connector ("QD" models) are also available (page 5).

Functional Schematic: SMA912 3-wire AC Sensors

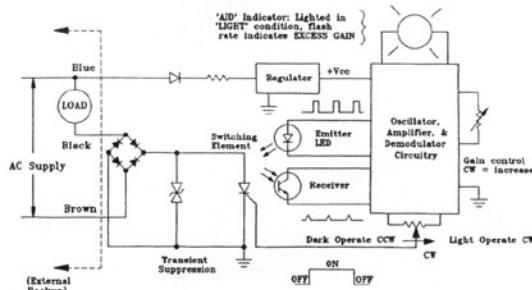

NOTE: Emitter units have no receiver phototransistor; receiver units have no emitter LED.



WARNING VALU-BEAM photoelectric presence sensors do NOT include the self-checking redundant circuitry necessary to allow their use in personnel safety applications. A sensor failure or malfunction can result in either an energized or a de-energized sensor output condition.

Never use these products as sensing devices for personnel protection. Their use as safety devices may create an unsafe condition which could lead to serious injury or death.

Only MACHINE-GUARD and PERIMETER-GUARD Systems, and other systems so designated, are designed to meet OSHA and ANSI machine safety standards for point-of-operation guarding devices. No other Banner sensors or controls are designed to meet these standards, and they must NOT be used as sensing devices for personnel protection.

VALU-BEAM SMA912 Series Sensors

Specifications

SUPPLY VOLTAGE: 24 to 130V ac (50/60Hz), except for SMA91E, ESR, and EF emitters, which operate from 10 to 250V ac or dc.

OUTPUT CONFIGURATION: solid-state switching element.

OUTPUT RATING: 500 mA continuous (60 VA); 5A inrush.

RESPONSE TIME: 4 milliseconds ON, 8 milliseconds OFF (except receiver-only units, which are 4 ms ON and 4 ms OFF). Response time specification of the load should be considered when important.

REPEATABILITY: 1.3 milliseconds, except for receiver-only units, which are 1.0 millisecond.

CONSTRUCTION: reinforced VALOX® housing, totally encapsulated, molded acrylic lenses, stainless steel hardware. Meets NEMA standards 1, 2, 3, 3S, 4, 4X, 12, and 13.

CABLE: 6' of PVC-jacketed 3-conductor cable standard. Three-pin quick-disconnect (QD) models are available optionally (one connector pin goes unused for emitters). Model MBCC-312 3-conductor cable for "QD" models must be purchased separately (see page 5).

ADJUSTMENTS: LIGHT/DARK OPERATE select switch and SENSITIVITY control potentiometer, both located on rear of sensor.

INDICATOR LED: top-mounted red "AID" system (patented) LED indicator lights when the sensor sees its own (or its emitter's) modulated light, and pulses at a rate proportional to the received signal strength. Model SMA91E emitter has a visible-red "tracer beam" which indicates "power on" and enables easy "line-of-sight" alignment.

OPERATING TEMPERATURE RANGE: -20 to +70 degrees C (-4 to +158 degrees F).

Dimension Drawing, Front View (cabled models)*

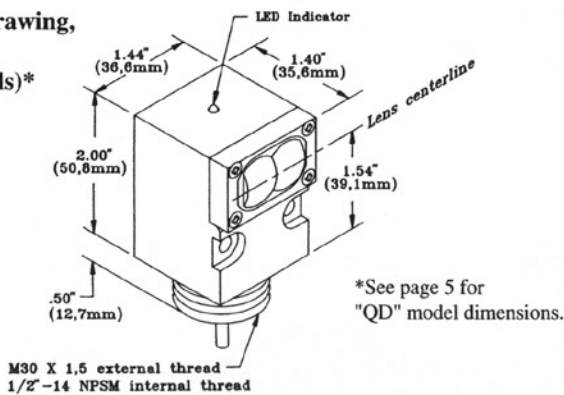

Rear View

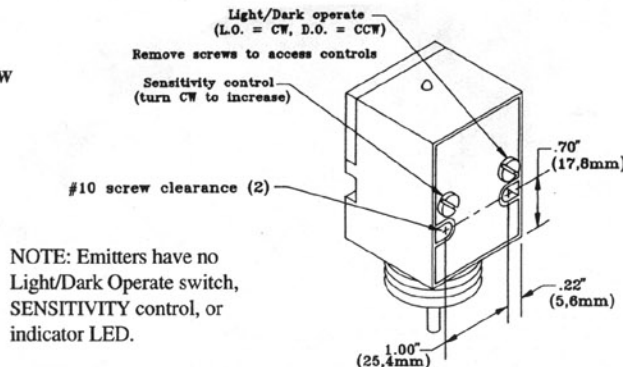

Hookup: All except emitters

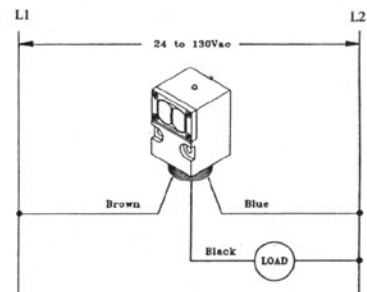

Hookup: SMA91 Emitters*

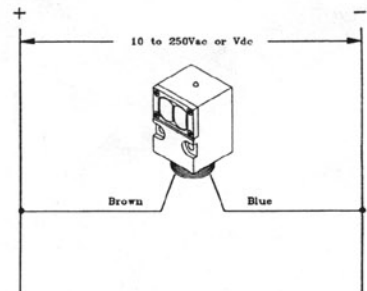

*There is no polarity for emitter hookup to ac voltage.

Mounting Brackets



Accessory mounting bracket model SMB900 (left) has curved mounting slots for versatility in mounting and orientation. The sensor mounts to the bracket by its threaded base, using a jam nut and lockwasher (both included). The bracket material is 11-gauge zinc-plated steel. The curved mounting slots have clearance for 1/4" screws.

Model SMB30S swivel-mount bracket (right) offers the ultimate in mounting versatility for VALU-BEAM and other sensors with M30 x 1,5 threads. The VALU-BEAM's base threads into the adjustable captive ball of the bracket, which is then locked in place. Bracket material is black VALOX®, and stainless steel mounting hardware is included.

Model SMB30C split-clamp bracket (not shown) is a VALOX® bracket similar to model SMB30S but without the adjustable ball. It grips the sensor by the sensor's threaded base. Hardware (included) is stainless steel.

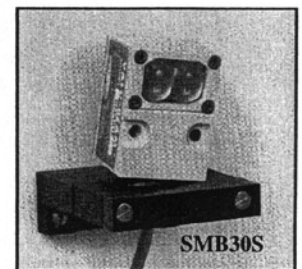

VALU-BEAM SMA912 Series Sensors

Sensing Mode

Models

Excess Gain

Beam Pattern

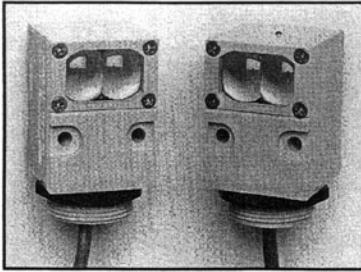

SMA91E & SMA91R

Voltage: 24 to 130V ac,
("E": 10-250V ac/dc)
Range: 200 feet (60 m)
Response: 8ms on/4 off
Repeatability: 1 ms
Beam: infrared, 880nm
Effective beam: 0.5" dia.

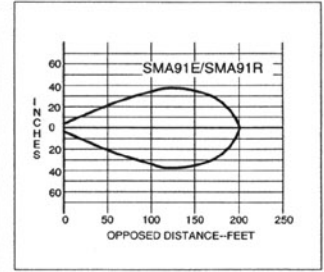
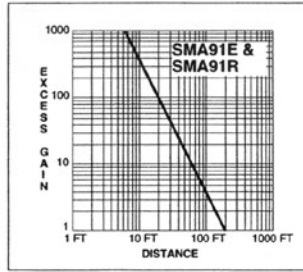

OPPOSED Mode

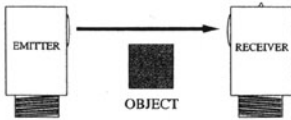

Opposed mode sensors have higher excess gain than other models, and therefore should be used whenever possible. The small size of these sensors makes them ideal for many conveyor applications, and their small effective beam size (particularly of the ESR/RSR models) enables them to reliably detect relatively small objects. VALU-BEAM opposed mode sensors have a visible red "tracer beam" which greatly simplifies sensor alignment. ESR/RSR models have a *wide* beam angle for very forgiving alignment within the 10 foot range. E/R models have a *narrow* beam spread and should be used when it is important to minimize optical "crosstalk" between adjacent emitter-receiver pairs at close range in multiple sensor arrays.

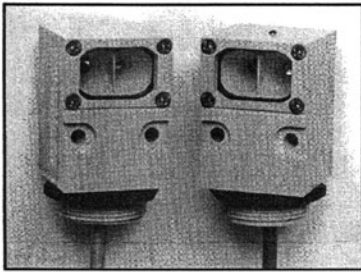

SMA91ESR & SMA91RSR

Voltage: 24 to 130V ac
Range: 10 feet (3 m)
Response: 8ms on/4 off
Repeatability: 1 ms
Beam: infrared, 880nm
Effective beam: 0.14" dia.

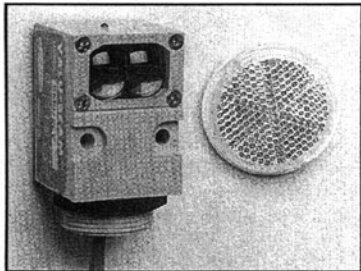
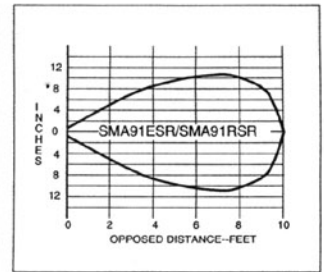
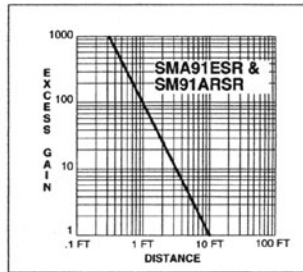

SMA912LV

Voltage: 24 to 130V ac
Range: 6 inches to 30 feet (9 m)
Response: 4ms on/4 off
Repeatability: 1.3 ms
Beam: visible red, 650nm

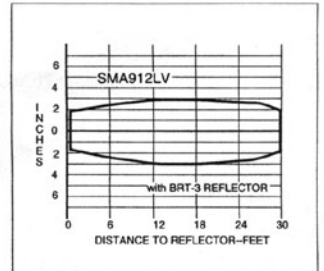
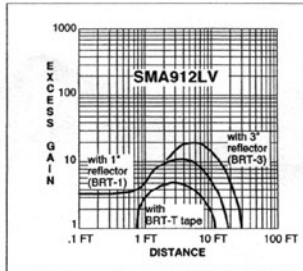

RETROREFLECTIVE

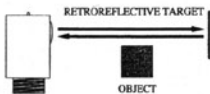

A visible-red light beam reduces the potential for false signals from highly reflective objects ("proxing") and simplifies alignment. *AG (anti-glare) models polarize the emitted light and filter out unwanted reflections*, making their use possible in applications otherwise unsuited to retroreflective sensing (when reduced excess gain is acceptable). Maximum range with "LV" units is attained when using the model BRT-3 3" corner cube reflector. For details on retroreflective target materials, see the Banner product catalog.

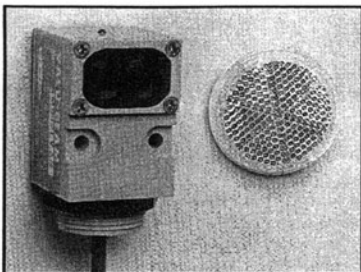

SMA912LVAG

(anti-glare filter)
Voltage: 24 to 130V ac
Range: 1 to 15 feet (4.5 m)
Response: 4ms on/4 off
Repeatability: 1.3 ms
Beam: visible red, 650nm (with polarizing filter)

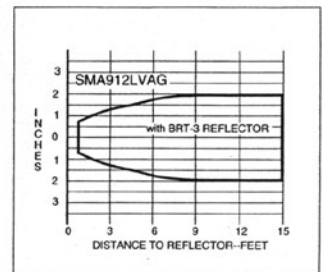
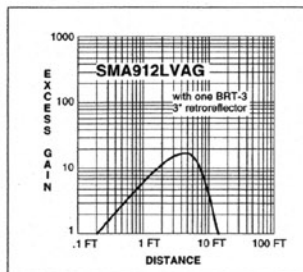

VALU-BEAM SMA912 Series Sensors

Sensing Mode

Models

Excess Gain

Beam Pattern

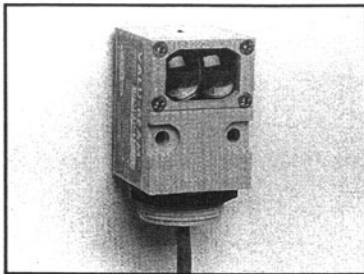

SMA912D

Voltage: 24 to 130V ac
Range: 30 inches (76 cm)
Response: 4ms on/4 off
Repeatability: 1.3 ms
Beam: infrared, 880nm

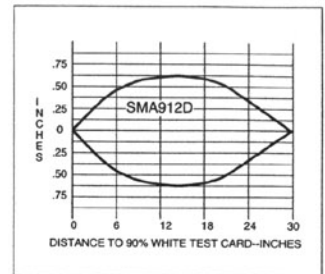
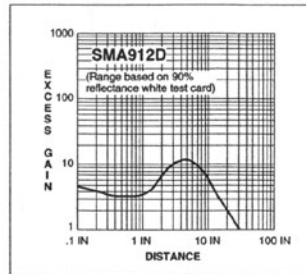

DIFFUSE Mode



These sensors operate by detecting the reflection of their own light from the object being sensed, and therefore require no special reflectors. "DSR" models have better response than "D" models to objects within 3 inches of the sensor. "DSR" models should be used when it is necessary to minimize sensor response to background objects.

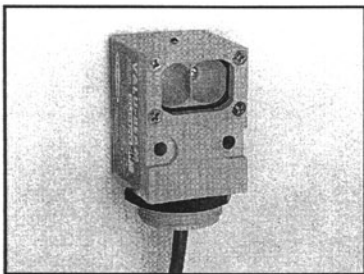

SMA912DSR

Voltage: 24 to 130V ac
Range: 15 inches (38cm)
Response: 4ms on/4 off
Repeatability: 1.3 ms
Beam: infrared, 880nm

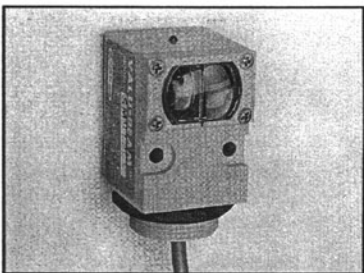
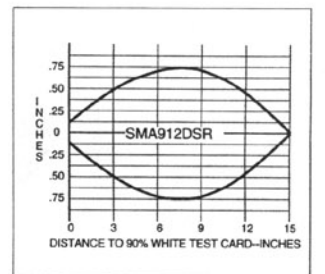
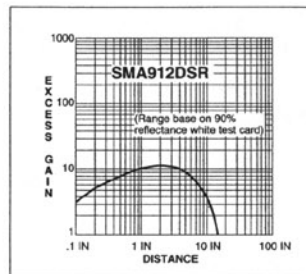

SMA912CV

Voltage: 24 to 130V ac
Focus at 1.5" (38 mm)
Response: 4ms on/4 off
Repeatability: 1.3 ms
Beam: visible red, 650nm

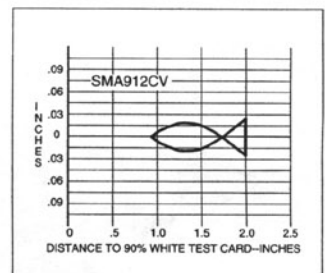
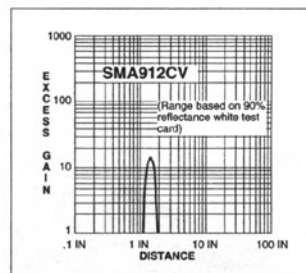

CONVERGENT Mode



VALU-BEAM convergent sensors produce a precise .06" diameter sensing spot at a focus point 1.5" in front of the sensor lens. Due to their very narrow depth of field, they excel at detecting small objects only a fraction of an inch away from backgrounds. They are also ideal for some high-contrast color-registration applications. Their visible red sensing beam simplifies alignment.

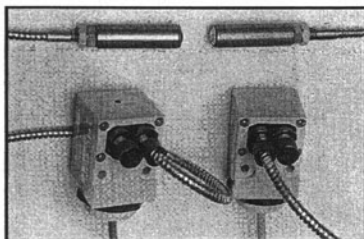

SMA91EF & SMA91RF

Voltage: 24 to 130V ac ("EF": 10-250V ac/dc)
Range: see E.G. curves
Response: 8ms on/4 off
Repeatability: 1 ms
Beam: infrared, 880nm

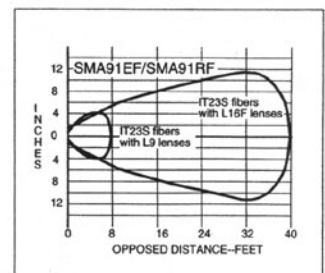
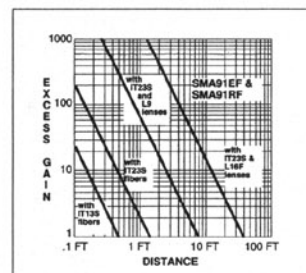

OPPOSED FIBER OPTIC MODE (glass fibers)

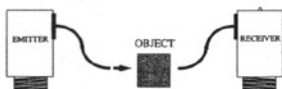

These opposed mode fiber optic emitter-receiver pairs are used where the separation between emitting and receiving fibers is greater than a few feet, or where it is inconvenient to run both fibers from a single VALU-BEAM sensor. These models have a watertight o-ring sealed sensor/fiber interface, and are compatible with all Banner glass fiber optic assemblies (see Banner catalog).

VALU-BEAM SMA912 Series Sensors

Sensing Mode

Models

Excess Gain

Beam Pattern

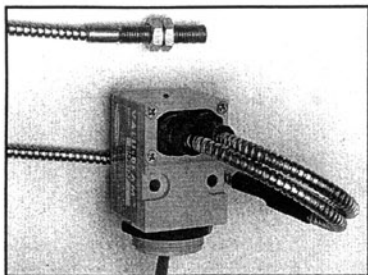

SMA912F

Voltage: 24 to 130V ac
 Range: see E.G. curves
 Response: 4 ms on/4 off
 Repeatability: 1.3 ms
 Beam: infrared, 880nm

FIBER OPTIC Mode (glass fibers)

OPPOSED

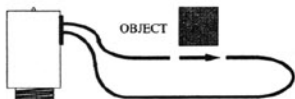

RETRO

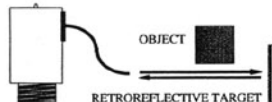

DIFFUSE



Fiber optic sensing is often the answer when, due to space or environmental limitations, the sensor itself cannot be placed at the actual sensing position. These sensors' powerful modulated infrared beam is compatible with all Banner glass fiber optics in the opposed, retroreflective, and diffuse sensing modes. See Banner catalog for glass fiber optic selection information. Sensor/fiber interface is waterproof to maintain complete sensing system moisture rejection.

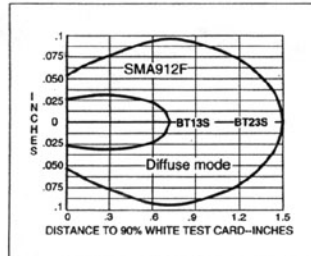
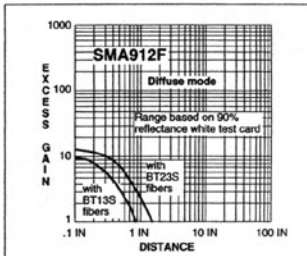
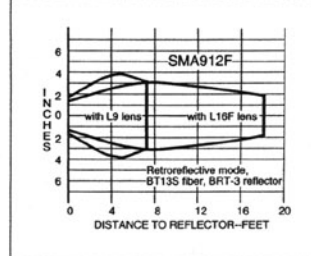
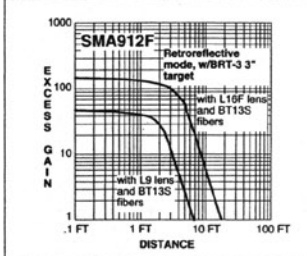
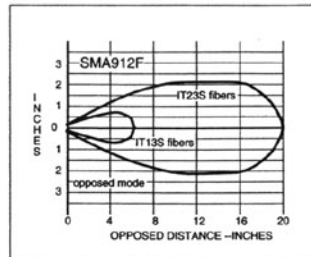
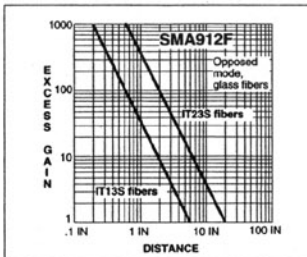

Cabling Options

All VALU-BEAM 912 Series sensors are available with the "QD" (Quick-Disconnect) option. A 3-pin connector, built into the sensor's base, mates with MBCC Series *minifast*™ quick disconnect cable. Cable must be ordered separately.

The diagrams (below, right) show pin configura-

tions. All SMA912 Series sensors (including emitters) use MBCC-312 cable. Mirror-image pin numbering is used for the mating cable connectors. Male contact pins are used in the sensor connectors. Cable connectors have female receptacles for wiring safety.

Standard VALU-BEAM sensors (non-QD models, normally supplied with an attached 6-foot long PVC-covered cable) may be supplied optionally with an attached 30-foot PVC-covered cable. Thirty feet is the most readily available length, but lengths longer than 30 feet may also be quoted. See also extension cables, page 6.

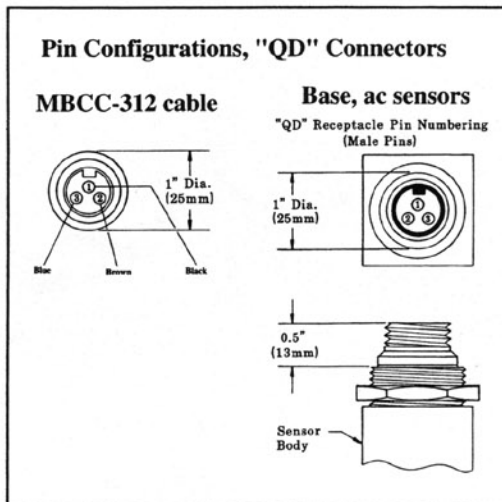
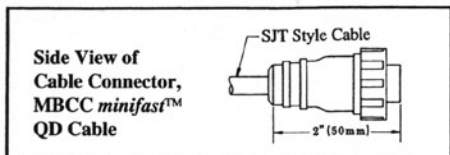
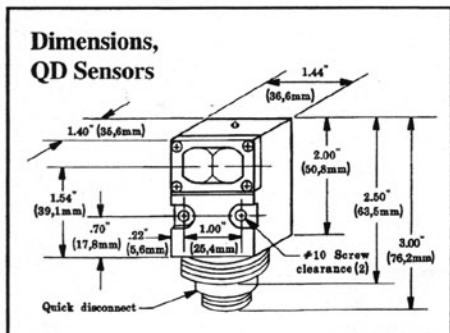

VALU-BEAM Accessories

Armored Jacket

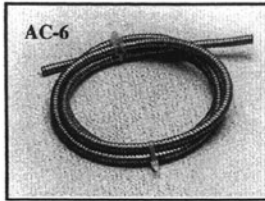

Compression Fitting

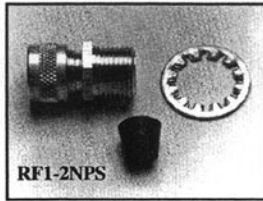

PVC Cable Tubing

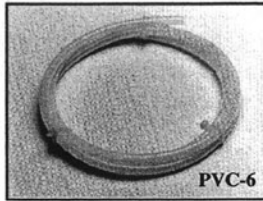

Extension Cable

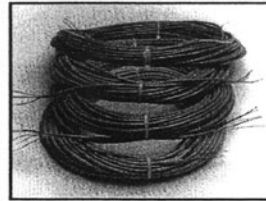

AC-6 armored cable jacket for VALU-BEAM sensors (not for "QD" models). Six-foot length. Size: I.D. = 5/16"; O.D. = 7/16".
RF1-2NPS Compression Fitting for attaching armored cable or PVC tubing to VALU-BEAM sensors (not for "QD" models).
PVC-6 flexible PVC tubing for VALU-BEAM sensors (not for "QD" models). Six-foot length. Size: I.D. = 1/4"; O.D. = 3/8".

Extension cable in 100-foot lengths:

Model EC900A-100 3-wire cable for SMA912 Series ac sensors. Wire colors: brown, blue, black.

NOTE: extension cable may be ordered in lengths greater than 100 feet on a quote basis.

HF1-2NPS Flexible Cable Protector

This black neoprene assembly easily slips over the wired cable and threads into the base of a VALU-BEAM sensor. The flexible extender prevents sharp cable bends and extends the life of cable that is subject to repeated flexing.

The HF1-2NPS includes a neoprene gland that compresses around the VALU-BEAM cable to provide an additional seal against moisture.

This flexible conduit protector is resistant to gasoline, alcohol, oil, grease, solvents, and weak acids. It has a working temperature range of -30° to +100°C (-22 to +212°F). It is UL recognized and CSA certified.

The HF1-2NPS also threads into the base of OMNI-BEAM, MULTI-BEAM, MAXI-BEAM, and SM30 Series sensors. It is sold in packages of 10 pieces.

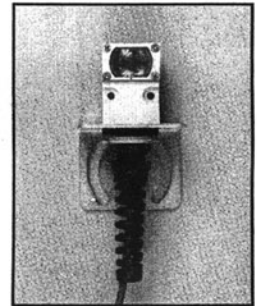

WARRANTY: Banner Engineering Corporation warrants its products to be free from defects for one year. Banner Engineering Corporation will repair or replace, free of charge, any product of its manufacture found to be defective at the time it is returned to the factory during the warranty period. This warranty does not cover damage or liability for the improper application of Banner products. This warranty is in lieu of any other warranty either expressed or implied.