

Secondary LDO Regulator Series for Local Power Supplies

500mA Secondary LDO Regulators for Local Power Supplies

BD□□KA5,BD□□KA5W Series,BD00KA5W Series

No.09024EAT01

●General Description

The BD□□KA5 series are low-saturation regulators that are available for output currents up to 500mA. The output voltage precision is $\pm 1\%$. These secondary LDO regulators are offered in several output voltages and package lineups with or without ON/OFF switches (that set the circuit current to 0 μ A at shutdown). This series can be used for a broad spectrum of applications ranging from TVs and car audio systems to HDDs, PCs, and DVDs. These regulators have a built-in overcurrent protection circuit that prevents the destruction of the IC, due to output short circuits and a thermal shutdown circuit.

●Features

- 1) Maximum output current : 500mA
- 2) Output voltage precision : $\pm 1\%$
- 3) Low-saturation voltage with PMOS output : 0.12V Typ.(I_o=200mA)
- 4) Built-in over-current protection circuit
- 5) Built-in thermal shutdown circuit
- 6) Shutdown switch(BD□□KA5WFP and BD□□KA5WF series)
- 7) TO252-3,TO252-5 and SOP8 package lineup
- 8) Operating temperature range : -40°C to +105°C
- 9) Ceramic capacitor compatible(recommended capacitance : 1 μ F or greater)

●Applications

Microcontrollers and all electronic devices that use logic circuits

●Product line up

Part Number	1.0	1.2	1.5	1.8	2.5	3.0	3.3	Variable	Package
BD□□KA5WFP	○	○	○	○	○	○	○	○	TO252-5
BD□□KA5WF	○	○	○	○	○	○	○	○	SOP8
BD□□KA5FP	○	○	○	○	○	○	○	-	TO252-3

 Part Number : BD□□KA5□□
 a b c

Symbol	Details			
a	Output Voltage Designation			
	□□	Output Voltage(V)	□□	Output Voltage(V)
	10	1.0V(Typ.)	25	2.5V(Typ.)
	12	1.2V(Typ.)	30	3.0V(Typ.)
	15	1.5V(Typ.)	33	3.3V(Typ.)
	18	1.8V(Typ.)	00	Variable Output Typ
b	Switch "W" included : Built-in shutdown switch "W" not included : No shutdown switch			
c	Package FP : TO252-5 / TO252-3 F : SOP8			

● Absolute Maximum Ratings (Ta=25°C)

Parameter	Symbol	Limits	Unit.
Power Supply Voltage	V _{CC}	-0.3~+7.0 ^{*1}	V
Output Control Terminal Voltage	V _{CTL}	-0.3~V _{CC} ^{*1}	V
Power Dissipation	TO252-3	1200 ^{*2}	mW
	TO252-5	1300 ^{*3}	
	SOP8	687.6 ^{*4}	
Operating Temperature Range	T _{opr}	-40~+105	°C
Ambient Storage Temperature	T _{stg}	-55~+150	°C
Maximum Junction Temperature	T _{jmax}	150	°C

*1 Must not exceed Pd

*2 When a 70mm×70mm×1.6mm glass epoxy board is used. Reduce by 9.6 mW/°C over 25°C.

*3 When a 70mm×70mm×1.6mm glass epoxy board is used. Reduce by 10.4mW/°C over 25°C.

*4 When a 70mm×70mm×1.6mm glass epoxy board is used. Reduce by 5.5 mW/°C over 25°C.

● Recommended Operating Range (Ta=25°C)

Parameter	Symbol	Min.	Max.	Unit.
Input Power Supply Voltage	V _{CC}	2.3	5.5	V
Output Current	I _o	0	500	mA
Output Voltage Configuration Range ^{*5}	V _o	1.0	4.0	V
Output Control Terminal Voltage	V _{CTL}	0	V _{CC}	V

*5 Only BD00KA5WFP and BD00KA5WF

● Electrical Characteristics (abridged)

BD□□KA5WFP / WF / FP

(Unless specified otherwise, Ta=25°C, V_{CTL}=2V, V_{CC}=2.5V (V_o=1.0V, 1.2V, 1.5V, 1.8V), V_{CC}=3.3V (V_o=2.5V), V_{CC}=5.0V (V_o=3.0V, 3.3V))

Parameter	Symbol	Min.	Typ.	Max.	Unit.	Conditions
Output Voltage	V _o	Vo(T)-0.015	Vo(T)	Vo(T)+0.015	V	I _o =200mA (V _o =1.0V, 1.2V)
		Vo(T) × 0.99	Vo(T)	Vo(T) × 1.01	V	I _o =200mA (V _o ≥ 1.5V)
Circuit Current at Shutdown	I _{sd}	-	0	1	μA	V _{CTL} = 0V, I _o = 0mA (during OFF mode)
Minimum I/O Voltage Difference ^{*6}	ΔV _d	-	0.12	0.20	V	I _o =200mA, V _{CC} =0.95 × V _o
Output Current Capacity	I _o	500	-	-	mA	
Input Stability ^{*7}	Reg.I	-	10	35	mV	V _{CC} =V _o +0.5V→5.5V, I _o =200mA
Load Stability	Reg.L	-	25	75	mV	I _o =0mA→500mA
Output Voltage Temperature Coefficient ^{*8}	T _{cv_o}	-	±100	-	ppm/°C	I _o =5mA, T _j =0~125°C

Vo(T) : Preset output voltage value

*6 When V_o ≥ 2.5V*7 When 1.0 ≤ V_o ≤ 1.8V, V_{CC}=2.3V→5.5V

*8 Design guarantee(100% shipping inspection not performed)

BD00KA5WFP / WF

(Unless specified otherwise, Ta=25°C, V_{CC}=2.5V, V_L=2V, R₁=30kΩ, R₂=30kΩ^{*9})

Parameter	Symbol	Min.	Typ.	Max.	Unit.	Conditions
Circuit Current at Shutdown	I _{sd}	-	0	1	μA	V _{CTL} = 0V, I _o = 0mA (during OFF mode)
Reference Voltage	V _{ADJ}	0.742	0.750	0.758	V	I _o =50mA
Minimum I/O Voltage Difference ^{*10}	ΔV _d	-	0.12	0.20	V	I _o =200mA, V _{CC} =0.95 × V _o
Output Current Capacity	I _o	500	-	-	mA	
Input Stability	Reg.I	-	10	35	mV	V _{CC} =V _o +0.5V→5.5V, I _o =200mA
Load Stability	Reg.L	-	25	75	mV	I _o =0mA→500mA
Output Voltage Temperature Coefficient ^{*11}	T _{cv_o}	-	±100	-	ppm/°C	I _o =5mA, T _j =0~125°C

*9 V_{OUT}=V_{ADJ}×(R₁+R₂)+R₁(V)V_{ADJ}×0.75V(Typ.)*10 When V_o ≥ 2.5V

*11 Design guarantee(100% shipping inspection not performed)

●Reference Data (Unless specified otherwise, $V_{CC}=25V, V_{CTL}=2V,$ and $I_o=0mA$)

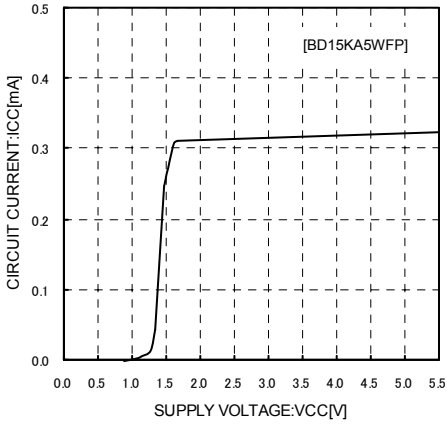

Fig.1 Circuit current

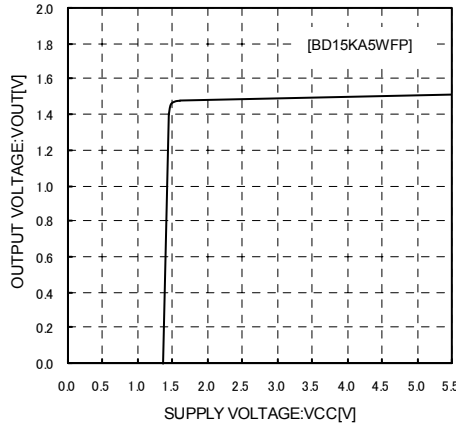

Fig.2 Input Stability ($I_o=0mA$)

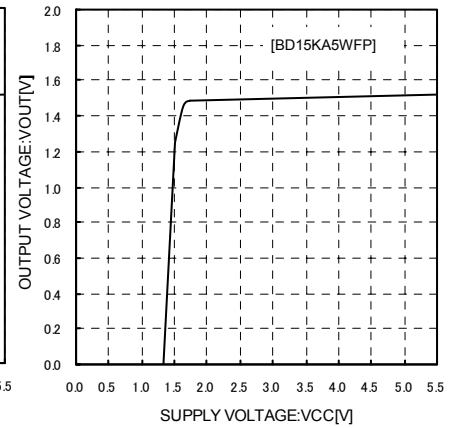

Fig.3 Input Stability ($I_o=500mA$)

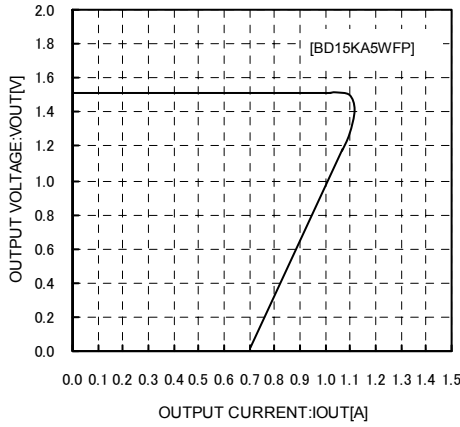

Fig.4 Load Stability

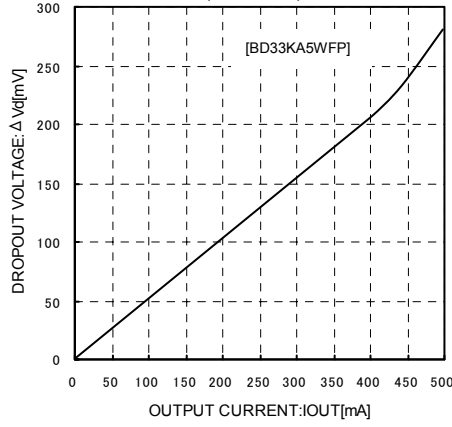

Fig.5 Input/Output Voltage Difference ($V_{CC}=3.135V$)

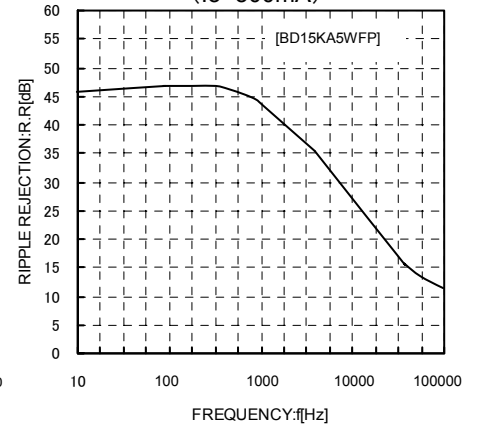

Fig.6 Ripple Rejection ($e_{in}=10dBV, I_o=100mA$)

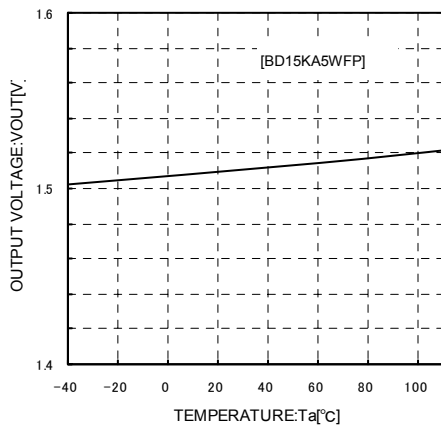

Fig.7 Output Voltage ($I_o=5mA$)

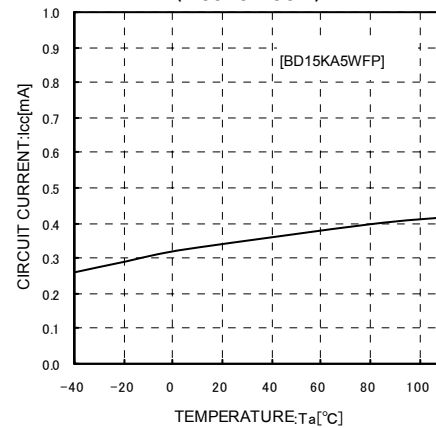

Fig.8 Circuit Current Temperature Characteristics

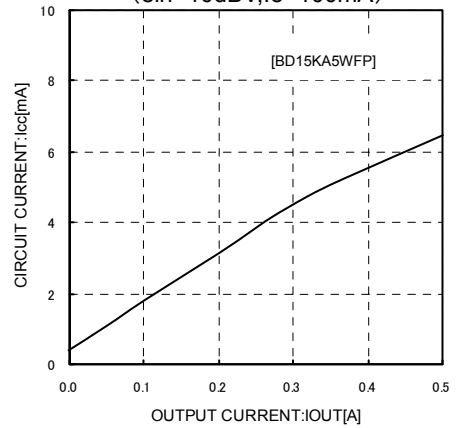

Fig.9 Circuit Current by load Level

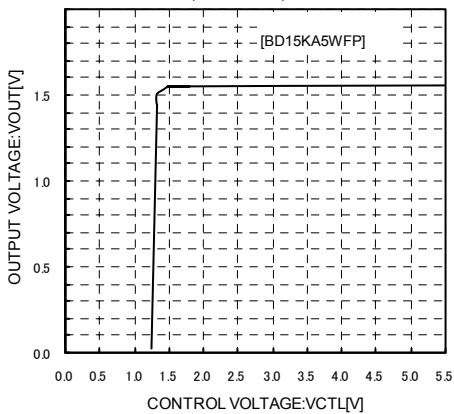

Fig.10 CTL Voltage vs. Output Voltage

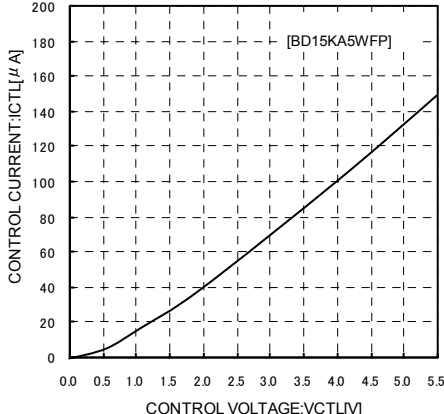

Fig.11 CTL Voltage vs. Output Current

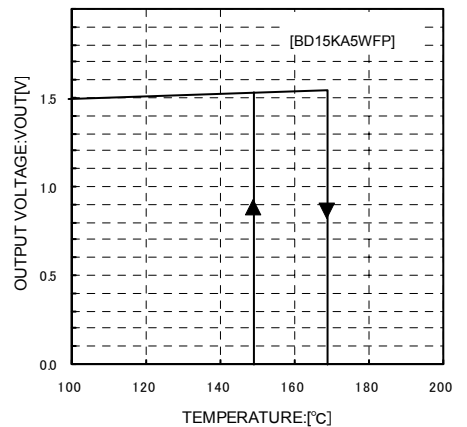

Fig.12 Thermal Shutdown Circuit Characteristics ($I_o=5mA$)

●Block diagrams, Standard circuit examples

[BD00KA5WFP]

* Output voltage configuration
 $V_{OUT} = V_{ADJ} \times (R1 + R2) \div R1 (V)$
 : $V_{ADJ} = 0.75V (Typ.)$
 : A value of approximately 30kΩ is recommended for R1.

Fig. 13

Pin No.	PinName	Function
1	CTL	Output voltage ON/OFF control
2	Vcc	Power supply voltage input
3	N.C.	Unconnected terminal
4	OUT	Voltage output
5	ADJ	Output voltage configuration terminal
FIN	GND	GND

TO252-5(BD00KA5WFP)

TOP VIEW

[BD00KA5WF]

* Output voltage configuration
 $V_{OUT} = V_{ADJ} \times (R1 + R2) \div R1 (V)$
 : $V_{ADJ} = 0.75V (Typ.)$
 : A value of approximately 30kΩ is recommended for R1.

Fig. 16

Pin No.	Pin Name	Function
1	OUT	Voltage output
2	ADJ	Output voltage configuration terminal
3	N.C.	Unconnected terminal
4	N.C.	Unconnected terminal
5	CTL	Output voltage ON/OFF control
6	GND	GND
7	GND	GND
8	Vcc	Power supply voltage input

SOP8(BD00KA5WF)

TOP VIEW

[BD□□KA5WFP]

Fig. 14

Pin No.	Pin Name	Function
1	CTL	Output voltage ON/OFF control
2	Vcc	Power supply voltage input
3	N.C.	Unconnected terminal
4	OUT	Voltage output
5	N.C.	Unconnected terminal
FIN	GND	GND

TO252-5(BD□□KA5WFP)

TOP VIEW

[BD□□KA5WF]

Fig. 17

Pin No.	Pin Name	Function
1	OUT	Voltage output
2	N.C.	Unconnected terminal
3	N.C.	Unconnected terminal
4	N.C.	Unconnected terminal
5	CTL	Output voltage ON/OFF control
6	GND	GND
7	GND	GND
8	Vcc	Power supply voltage input

SOP8(BD□□KA5WF)

TOP VIEW

[BD□□KA5FP]

Fig. 15

Pin No.	Pin Name	Function
1	Vcc	Power supply voltage input
2	N.C.	Unconnected terminal
3	OUT	Voltage output
FIN	GND	GND

TO252-3(BD□□KA5FP)

TOP VIEW

N.C. pins are electrically open to the inside of the IC chip.

● Input / Output Equivalent Circuit Diagrams

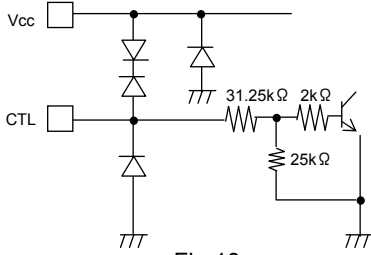

Fig.18

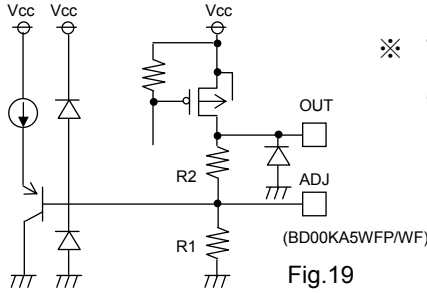

Fig.19

※ With BD00KA5WFP/WF, R1 and R2 are connected outside the IC between ADJ and GND and between OUT and ADJ.

● Thermal Design

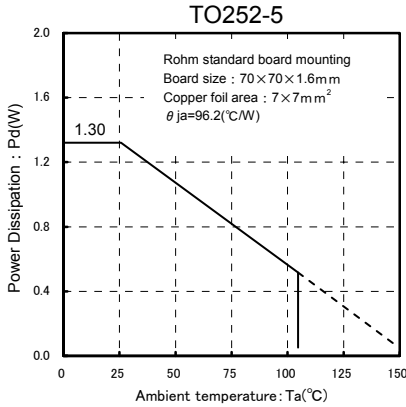

Fig.20 Power Dissipation heat reducing characteristics

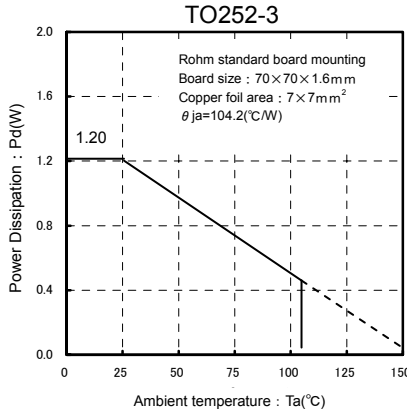

Fig.21 Power Dissipation heat reducing characteristics

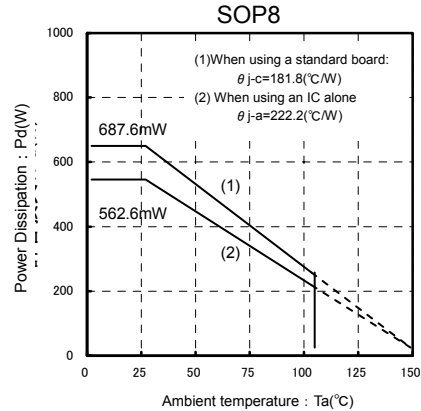

Fig.22 Power Dissipation heat reducing characteristics

When using at temperatures over $T_a=25^{\circ}\text{C}$, please refer to the power dissipation shown in Fig.20 through 22. The IC characteristics are closely related to the temperature at which the IC is used, so if the temperature exceeds the maximum junction temperature $T_{j\text{MAX}}$, the device may malfunction or be destroyed. The heat of the IC requires sufficient consideration regarding instantaneous destruction and long-term operation reliability. In order to protect the IC from thermal damage, it is necessary to operate it at temperatures less than the maximum junction temperature $T_{j\text{MAX}}$. Even when the ambient temperature T_a is a normal temperature (25°C), the chip (junction) temperature T_j may be quite high, so please operate the IC at temperatures less than the acceptable loss P_d .

The calculation method for power consumption $P_c(\text{W})$ is as follows :

$$P_c = (V_{cc}-V_o) \times I_o + V_{cc} \times I_{cca}$$

$$\text{Acceptable loss } P_d \geq P_c$$

Solving for the load current I_o in order to operate within the acceptable loss,

$$I_o \leq \frac{P_d - V_{cc} \times I_{cca}}{V_{cc} - V_o}$$

V_{cc} : Input voltage
 V_o : Output voltage
 I_o : Load current
 I_{cca} : Circuit current

It is then possible to find the maximum load current $I_{o\text{MAX}}$ with respect to the applied voltage V_{cc} at the time of thermal design.

Calculation Example

Example 1) When $T_a=85^{\circ}\text{C}$, $V_{cc}=2.5\text{V}$, $V_o=1.0\text{V}$

$$I_o \leq \frac{0.676 - 2.5 \times I_{cca}}{2.5 - 1.0}$$

$$I_o \leq 440\text{mA} \quad (I_{cca} : 2\text{mA})$$

BA10KA5WFP (TO252-5 packaging)

$$\theta_{ja}=96.2^{\circ}\text{C/W} \rightarrow -10.4\text{mW}/^{\circ}\text{C}$$

$$25^{\circ}\text{C}=1300\text{mW} \rightarrow 85^{\circ}\text{C}=676\text{mW}$$

Please refer to the above information and keep thermal designs within the scope of acceptable loss for all operating temperature ranges.

The power consumption P_c of the IC when there is a short circuit (short between V_o and GND) is :

$$P_c = V_{cc} \times (I_{cca} + I_{\text{short}})$$

* I_{short} : Short circuit current

●Terminal Vicinity Settings and Cautions

- Vcc Terminal
Please attach a capacitor (greater than 1 μF) between Vcc and GND.
The capacitance values differ depending on the application, so chose a capacitor with sufficient margin and verify the operation on actual board.
- GND Terminal
Please be sure to keep the set ground and IC ground at the same potential level so that a potential difference does not arise between them. If a potential difference arises between the set ground and the IC ground, the preset voltage will not be output properly, causing the system to become unstable. Please reduce the impedance by making the ground patterns as wide as possible and reducing the distance between the set ground and the IC ground as much as possible.
- CTL Terminal

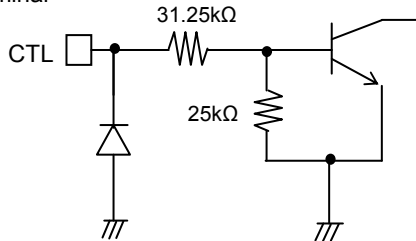

Fig.23 Input equivalent circuit

The CTL terminal is turned ON at 2.0V and higher, and OFF at 0.8V and lower, within the operating power supply voltage range. The power supply and the CTL terminal may be started up and shut down in any order without problems.

●Vo Terminal

Please be sure to attach an anti-oscillation capacitor between Vo and GND.

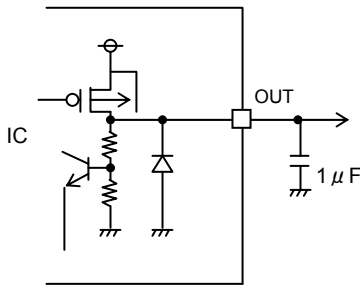

Fig.24 Output Equivalent Circuit

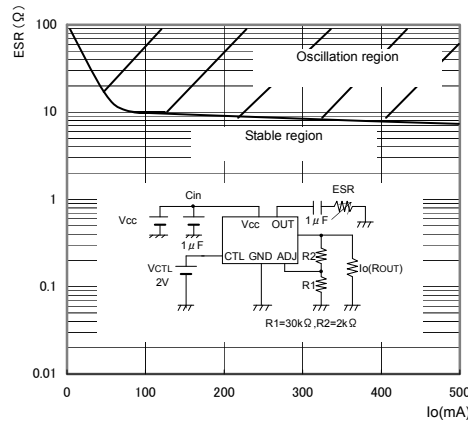
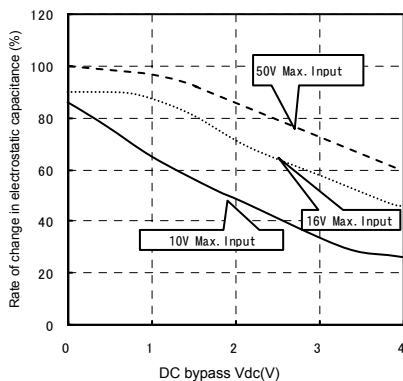
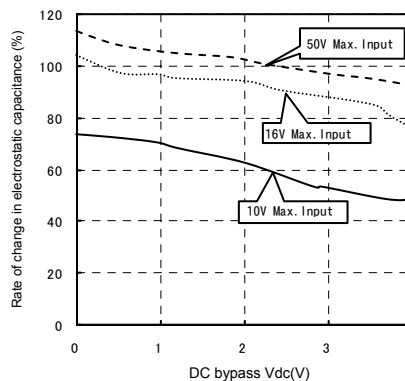

Fig.25 ESR-Io Characteristics

Be sure to place an anti-oscillation capacitor between the output terminal and the GND. Oscillations may arise if the capacitance value changes, due to factors such as temperature changes. A 1 μF capacitor with small internal series resistance (ESR) such as a ceramic capacitor is recommended as an anti-oscillation capacitor. Ceramic capacitors generally have favorable temperature characteristics and DC bypass characteristics. When selecting a ceramic capacitor, a high voltage capacitor (good DC bypass characteristics) with temperature characteristics that are superior to those of X5R or X7R, is recommended. In applications where input voltage and load fluctuations are rapid, please decide on a capacitor after sufficiently confirming its properties according to its specifications in the actual application.



(a) Capacitance-bypass characteristics (Y5V)



(b) Capacitance-bypass characteristics (X5R,X7R)

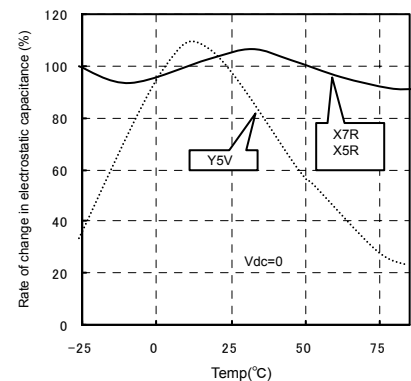

(c) Capacitance-temperature characteristics (X5R,X7R,Y5V)

Fig.26 :General characteristics of ceramic capacitors

●Other Caution

○Protection Circuits

Over-current Protection Circuit

A built-in over-current protection circuit corresponding to the current capacity prevents the destruction of the IC when there are load shorts. This protection circuit is a “7”-shaped current control circuit that is designed such that the current is restricted and does not latch even when a large current momentarily flows through the system with a high-capacitance capacitor. However, while this protection circuit is effective for the prevention of destruction due to unexpected accidents, it is not suitable for continuous operation or transient use. Please be aware when creating thermal designs that the over-current protection circuit has negative current capacity characteristics with regard to temperature.

○Thermal Shutdown Circuit (Thermal Protection)

This system has a built-in temperature protection circuit for the purpose of protecting the IC from thermal damage. As shown in Fig. 20-22, this must be used within the range of acceptable loss, but if the acceptable loss is continuously exceeded, the chip temperature T_j increases, causing the thermal shutdown circuit to operate. When the thermal shutdown circuit operates, the operation of the circuit is suspended. The circuit resumes operation immediately after the chip temperature T_j decreases, so the output repeats the ON and OFF states (Please refer to Figs.12 for the temperatures at which the temperature protection circuit operates).

There are cases in which the IC is destroyed due to thermal runaway when it is left in the overloaded state. Be sure to avoid leaving the IC in the overloaded state.

○Reverse Current

In order to prevent the destruction of the IC when a reverse current flows through the IC, it is recommended that a diode be placed between the Vcc and Vo and a pathway be created so that the current can escape (Refer to Fig.27).

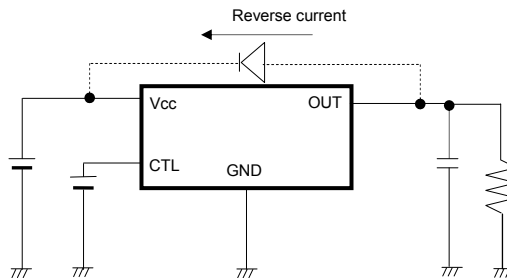

Fig.27 : Bypass diode

○This IC is BI-CMOS IC that has a P-board (substrate) and P+ isolation between each element, as shown in Fig.28. A P-N junction is formed between this P-layer and the N-layer of each element, and the P-N junction operates as :

- a parasitic diode when the electric potential relationship is GND > Terminal A, GND > Terminal B, or
- a parasitic transistor when the electric potential relationship is Terminal B > GND > Terminal A.

Parasitic elements are structurally inevitable in the IC. The operation of parasitic elements induces mutual interference between circuits, causing malfunctions and eventually the destruction of the IC. Take precaution as not to use the IC in ways that would cause parasitic elements to operate. For example, applying a voltage that is lower than the GND (P-board) to the input terminal.

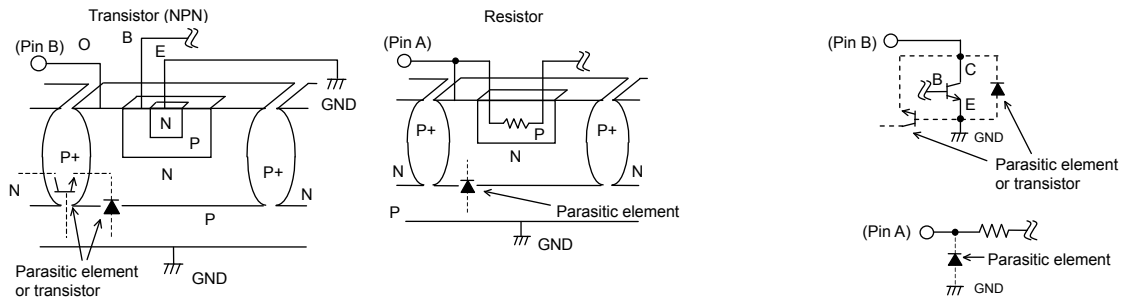
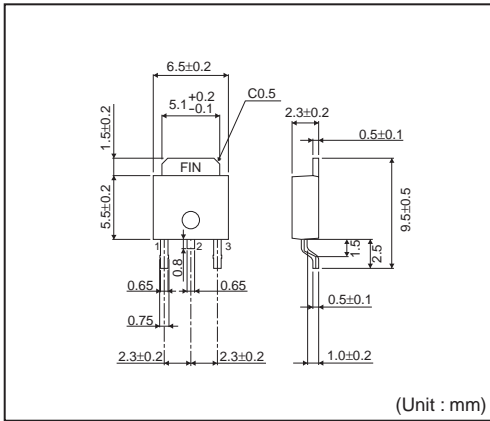

Fig. 28 : Basic structure example

●Ordering part number

B	D	1	8	K	A	5	W	F	P	-	E	2
Part number		Output voltage 00: Variable Other: Fixed		Current capacity 500mA			Shutdown switch W : Include	パッケージ FP : TO252-3 TO252-5 F : SOP8		Packaging and forming specification E2: Embossed tape and reel		

TO252-3



<Tape and Reel information>

Tape	Embossed carrier tape
Quantity	2000pcs
Direction of feed	E2 (The direction is the 1pin of product is at the lower left when you hold reel on the left hand and you pull out the tape on the right hand)

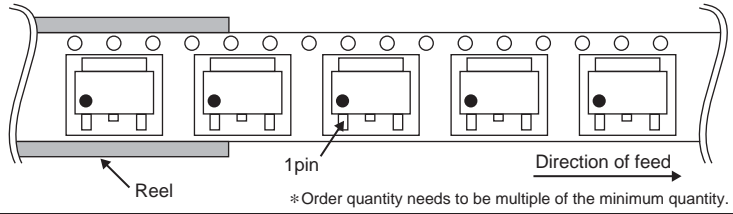

TO252-5

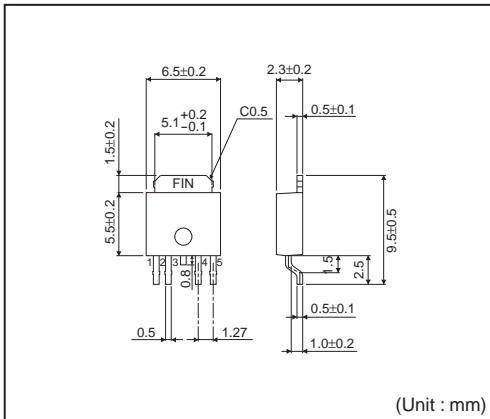

<Tape and Reel information>

Tape	Embossed carrier tape
Quantity	2000pcs
Direction of feed	E2 (The direction is the 1pin of product is at the lower left when you hold reel on the left hand and you pull out the tape on the right hand)

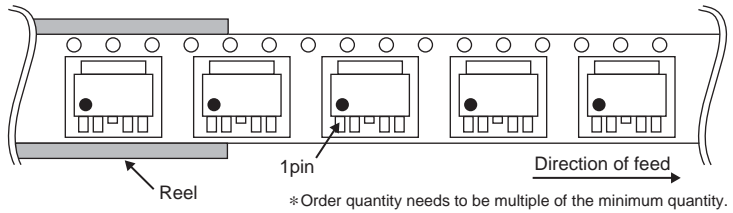

SOP8

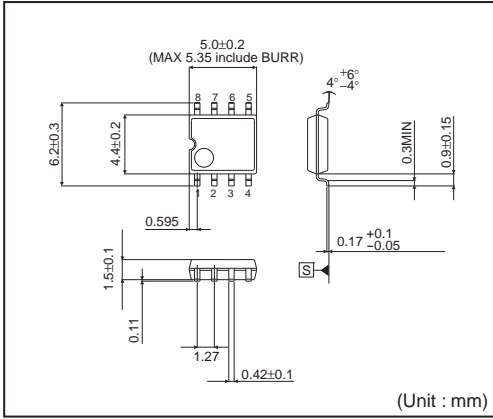

<Tape and Reel information>

Tape	Embossed carrier tape
Quantity	2500pcs
Direction of feed	E2 (The direction is the 1pin of product is at the upper left when you hold reel on the left hand and you pull out the tape on the right hand)

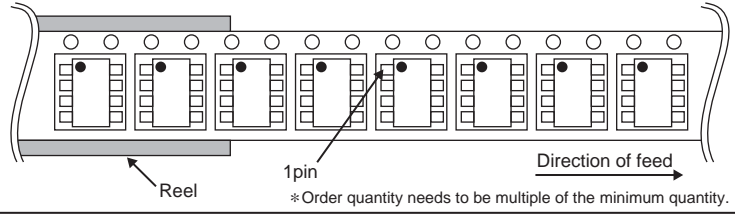

Notes

No copying or reproduction of this document, in part or in whole, is permitted without the consent of ROHM Co.,Ltd.

The content specified herein is subject to change for improvement without notice.

The content specified herein is for the purpose of introducing ROHM's products (hereinafter "Products"). If you wish to use any such Product, please be sure to refer to the specifications, which can be obtained from ROHM upon request.

Examples of application circuits, circuit constants and any other information contained herein illustrate the standard usage and operations of the Products. The peripheral conditions must be taken into account when designing circuits for mass production.

Great care was taken in ensuring the accuracy of the information specified in this document. However, should you incur any damage arising from any inaccuracy or misprint of such information, ROHM shall bear no responsibility for such damage.

The technical information specified herein is intended only to show the typical functions of and examples of application circuits for the Products. ROHM does not grant you, explicitly or implicitly, any license to use or exercise intellectual property or other rights held by ROHM and other parties. ROHM shall bear no responsibility whatsoever for any dispute arising from the use of such technical information.

The Products specified in this document are intended to be used with general-use electronic equipment or devices (such as audio visual equipment, office-automation equipment, communication devices, electronic appliances and amusement devices).

The Products specified in this document are not designed to be radiation tolerant.

While ROHM always makes efforts to enhance the quality and reliability of its Products, a Product may fail or malfunction for a variety of reasons.

Please be sure to implement in your equipment using the Products safety measures to guard against the possibility of physical injury, fire or any other damage caused in the event of the failure of any Product, such as derating, redundancy, fire control and fail-safe designs. ROHM shall bear no responsibility whatsoever for your use of any Product outside of the prescribed scope or not in accordance with the instruction manual.

The Products are not designed or manufactured to be used with any equipment, device or system which requires an extremely high level of reliability the failure or malfunction of which may result in a direct threat to human life or create a risk of human injury (such as a medical instrument, transportation equipment, aerospace machinery, nuclear-reactor controller, fuel-controller or other safety device). ROHM shall bear no responsibility in any way for use of any of the Products for the above special purposes. If a Product is intended to be used for any such special purpose, please contact a ROHM sales representative before purchasing.

If you intend to export or ship overseas any Product or technology specified herein that may be controlled under the Foreign Exchange and the Foreign Trade Law, you will be required to obtain a license or permit under the Law.



Thank you for your accessing to ROHM product informations.
More detail product informations and catalogs are available, please contact us.

ROHM Customer Support System

<http://www.rohm.com/contact/>