

LM20143

Application Note 1691 LM20143 Evaluation Board



Literature Number: SNVA277A

LM20143 Evaluation Board

National Semiconductor
Application Note 1691
Dennis Hudgins
October 30, 2007



Introduction

The LM20143 is a full featured buck switching regulator capable of driving up to 3A of load current. The switching frequency of the LM20143 can be varied from 500kHz to 1.5MHz with an external resistor allowing the size of the power stage components to be reduced while still providing efficient operation. The LM20143 is capable of converting an input voltage between 2.95V and 5.5V down to an output voltage as low as 0.8V. Fault protection features include cycle-by-cycle current limit, output power good, and output over-voltage protection. The dual function soft-start/tracking pin can be used to control the startup response of the LM20143, and the precision enable pin can be used to easily sequence the LM20143 in applications with sequencing requirements. The LM20143 is available in an eTSSOP-16 package with an exposed pad for enhanced thermal performance.

The LM20143 evaluation board has been designed to balance overall solution size with the efficiency of the regulator. The evaluation board measures just under 1.3" x 1.1" on a two layer PCB, with all components placed on the top layer. The power stage and compensation components of the LM20143 evaluation board have been optimized for an input voltage of 5V and a switching frequency of 1.5 MHz, but for testing purposes, the input can be varied across the entire operating range. The output voltage of the evaluation board is nominally 1.2V, but this voltage can be easily changed by replacing one of the feedback resistors (R_{FB1} or R_{FB2}). The control loop compensation of the LM20143 evaluation board has been designed to provide a stable solution over the entire input and output voltage range with a reasonable transient response. The EN pin must be above 1.18V (typ) on the board to initiate switching. If the EN function is not necessary, the EN pin should be externally tied to V_{IN} .

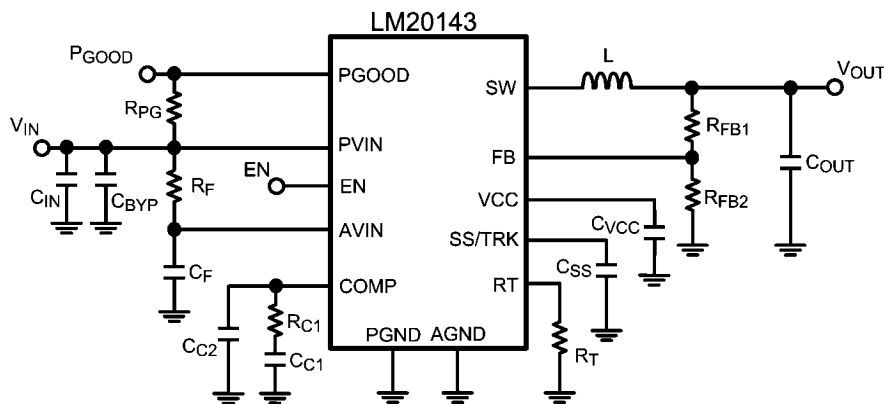

30032901

FIGURE 1. Evaluation Board Schematic

Bill of Materials

Designator	Description	Part Number	Qty	Manufacturer
U1	Synchronous Buck Regulator	LM20143MH	1	National Semiconductor
C _{IN}	47 μ F, 1210, X5R, 6.3V	GRM32ER60J476ME20	1	Murata
C _{BYP}	1 μ F, 0603, X5R, 6.3V	GRM188R60J105KA01	1	Murata
C _{OUT}	47 μ F, 1210, X5R, 6.3V	GRM32ER60J476ME20	1	Murata
L	1.2 μ H, 17 m Ω	DO1813H-122ML	1	Coilcraft
R _F	1 Ω , 0603	CRCW06031R0J-e3	1	Vishay-Dale
C _F	100 nF, 0603, X7R, 16V	GRM188R71C104KA01	1	Murata
C _{VCC}	1 μ F, 0603, X5R, 6.3V	GRM188R60J105KA01	1	Murata
R _{PG}	10 k Ω , 0603	CRCW06031002F-e3	1	Vishay-Dale
R _{C1}	1 k Ω , 0603	CRCW06031001F-e3	1	Vishay-Dale
C _{C1}	4.7 nF, 0603, X7R, 25V	VJ0603Y472KXXA	1	Vishay-Vitramon
C _{C2}	OPEN	OPEN	0	N/A
C _{SS}	33 nF, 0603, X7R, 25V	VJ0603Y333KXXA	1	Vishay-Vitramon
R _{FB1}	4.99 k Ω , 0603	CRCW06034991F-e3	1	Vishay-Dale
R _{FB2}	10 k Ω , 0603	CRCW06031002F-e3	1	Vishay-Dale
R _T	49.9 k Ω , 0603	CRCW06034992F-e3	1	Vishay-Dale
Test Points	Test Points	160-1026-02-01-00	7	Cambion

Connection Descriptions

Terminal Silkscreen	Description
VIN	This terminal is the input voltage to the device. The device will operation over the input voltage range of 2.95V to 5.5V. The absolute maximum voltage rating for this pin is 6V.
GND	This terminal is the ground connection to the device. There are two different GND connections on the PCB. One should be used for the input supply and the other for the load.
VOUT	This terminal connects to the output voltage of the power supply and should be connected to the load.
EN	This terminal connects to the enable pin of the device. This terminal should be connected to V _{IN} or driven externally. If driven externally, a voltage typically greater than 1.18V will enable the device. The operating voltage for this pin should not exceed 5.5V. The absolute maximum voltage rating on this pin is 6V.
SS/TRACK	This terminal provides access to the SS/TRK pin of the device. Connections to this terminal are not needed for most applications. The feedback pin of the device will track the voltage on the SS/TRK pin if it is driven with an external voltage source that is below the 0.8V reference. The voltage on this pin should not exceed 5.5V during normal operation. The absolute maximum voltage rating on this pin is 6V.
PGOOD	This terminal connects to the power good output of the device. There is a 10 k Ω pull-up resistor from this pin to the input voltage. The voltage on this pin should not exceed 5.5V during normal operation and has an absolute maximum voltage rating of 6V.

Performance Characteristics

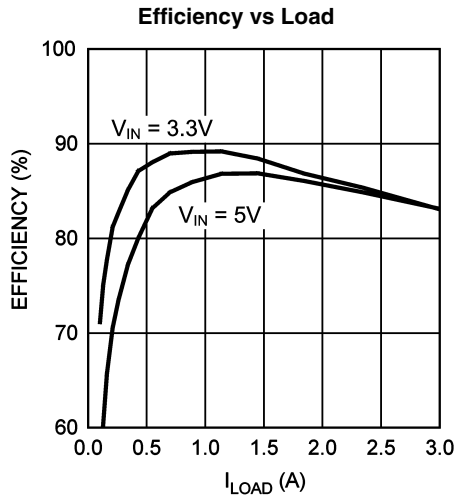

30032915

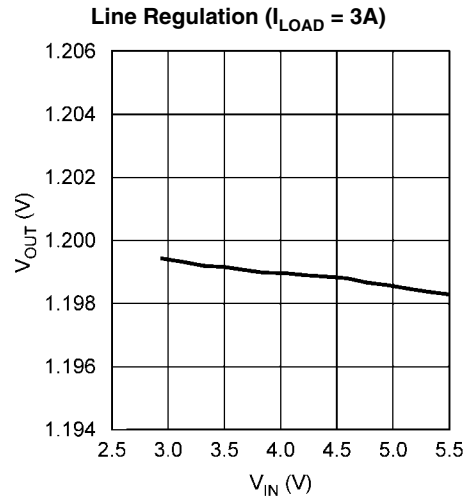

30032916

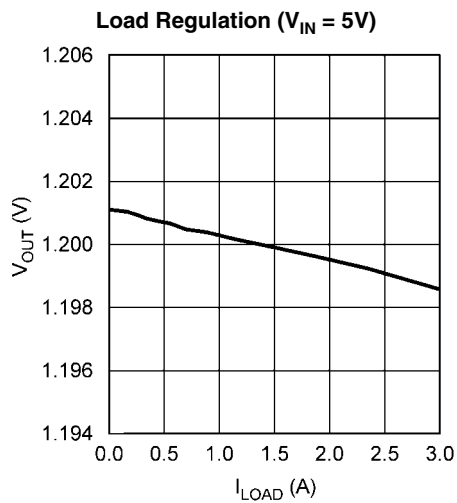

30032917

0.5A to 3A Load Transient Response (200 μs /DIV)

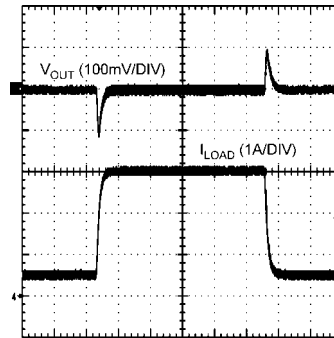

30032919

Startup Waveform

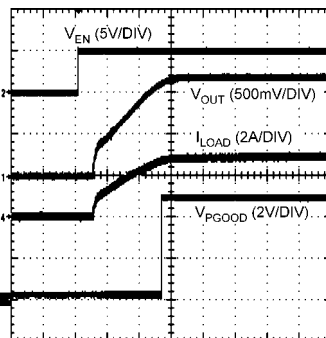

30032920

Component Selection

This section provides a walk-through of the design process of the LM20143 evaluation board. Unless otherwise indicated all equations assume units of Amps (A) for current, Farads (F) for capacitance, Henries (H) for inductance, and Volts (V) for voltages.

INPUT CAPACITOR

The required RMS current rating of the input capacitor for a buck regulator can be estimated by the following equation:

$$I_{CIN(RMS)} = I_{OUT} \sqrt{D(1-D)}$$

The variable D refers to the duty cycle, and can be approximated by:

$$D = \frac{V_{OUT}}{V_{IN}}$$

From this equation, it follows that the maximum $I_{CIN(RMS)}$ requirement will occur at a full 3A load current with the system operating at 50% duty cycle. Under this condition, the maximum $I_{CIN(RMS)}$ is given by:

$$I_{CIN(RMS)} = 3A \sqrt{0.5 \times 0.5} = 1.5A$$

Ceramic capacitors feature a very large I_{RMS} rating in a small footprint, making a ceramic capacitor ideal for this application. A 47 μ F X5R ceramic capacitor from Murata provides the necessary input capacitance for the evaluation board. For improved bypassing, a small 1 μ F high frequency capacitor is placed in parallel with the 47 μ F bulk capacitor to filter high frequency noise pulses on the supply.

AVIN FILTER

An RC filter should be added to prevent any switching noise on PVIN from interfering with the internal analog circuitry connected to AVIN. These can be seen on the schematic as components R_F and C_F . There is a practical limit to the size of the resistor R_F as the AVIN pin will draw a short 60mA burst of current during startup, and if R_F is too large the resulting voltage drop can trigger the UVLO comparator. For the demo board a 1 Ω resistor is used for R_F ensuring that UVLO will not be triggered after the part is enabled. A recommended 1 μ F C_F capacitor coupled with the 1 Ω resistor provides greater than 16dB of attenuation at the set 1.5 MHz switching frequency.

INDUCTOR

As per the datasheet recommendations, the inductor value should initially be chosen to give a peak to peak ripple current equal to roughly 30% of the maximum output current. The peak to peak inductor ripple current can be calculated by the equation:

$$\Delta I_{P-P} = \frac{(V_{IN} - V_{OUT}) \times D}{L \times f_{SW}}$$

Rearranging this equation and solving for the inductance reveals that for this application ($V_{IN} = 5V$, $V_{OUT} = 1.2V$, $f_{SW} = 1.5$ MHz, and $I_{OUT} = 3A$) the nominal inductance value is roughly 0.68 μ H. However, a final inductance of 1.2 μ H was selected

to accommodate the full output voltage range of the device. This results in a peak-to-peak ripple current of 507 mA and 623 mA when the converter is operating from 5V and 3.3V respectively. Once an inductance value is calculated, an actual inductor needs to be selected based on a trade-off between physical size, efficiency, and current carrying capability. For the LM20143 evaluation board, a Coilcraft DO1813H-122ML inductor offers a good balance between efficiency (17 m Ω DCR), size, and saturation current rating (5.3A I_{SAT} rating).

OUTPUT CAPACITOR

The value of the output capacitor in a buck regulator influences the voltage ripple that will be present on the output voltage, as well as the large signal output voltage response to a load transient. Given the peak-to-peak inductor current ripple (ΔI_{P-P}) the output voltage ripple can be approximated by the equation:

$$\Delta V_{OUT} = \Delta I_{P-P} \times \left[R_{ESR} + \frac{1}{8 \times f_{SW} \times C_{OUT}} \right]$$

The variable R_{ESR} above refers to the ESR of the output capacitor. As can be seen in the above equation, the ripple voltage on the output can be divided into two parts, one of which is attributed to the AC ripple current flowing through the ESR of the output capacitor and another due to the AC ripple current actually charging and discharging the output capacitor. The output capacitor also has an effect on the amount of droop that is seen on the output voltage in response to a load transient event.

For the evaluation board, a Murata 47 μ F ceramic capacitor is selected for the output capacitor to provide good transient and DC performance in a relatively small package. From the technical specifications of this capacitor, the ESR is roughly 3 m Ω , and the effective in-circuit capacitance is approximately 32 μ F (reduced from 47 μ F due to the 1.2V DC bias). With these values, the peak to peak voltage ripple on the output when operating from a 5V input can be calculated to be 3 mV.

C_{SS}

A soft-start capacitor can be used to control the startup time of the LM20143 voltage regulator. The startup time of the regulator when using a soft-start capacitor can be estimated by the following equation:

$$t_{SS} = \frac{0.8V \times C_{SS}}{I_{SS}}$$

For the LM20143, I_{SS} is nominally 5 μ A. For the evaluation board, the soft-start time has been designed to be roughly 5 ms, resulting in a C_{SS} capacitor value of 33 nF.

C_{VCC}

The C_{VCC} capacitor is necessary to bypass an internal 2.7V subregulator. This capacitor should be sized equal to or greater than 1 μ F, but less than 10 μ F. A value of 1 μ F is sufficient for most applications..

C_{C1}

The capacitor C_{C1} is used to set the crossover frequency of the LM20143 control loop. Since this board was optimized to be stable over the full input and output voltage range, the value of C_{C1} was selected to be 4.7 nF. Once the operating

conditions for the device are known, the transient response can be optimized by reducing the value of C_{C1} and calculating the value for R_{C1} as outlined in the next section.

R_{C1}

Once the value of C_{C1} is known, resistor R_{C1} is used to place a zero in the control loop to cancel the output filter pole. This resistor can be sized according to the equation:

$$R_{C1} = \left[\frac{C_{C1}}{C_{OUT}} \times \left[\frac{I_{OUT}}{V_{OUT}} + \frac{1-D}{f_{SW} \times L} + \frac{15 \times D}{V_{IN}} \right] \right]^{-1}$$

For stability purposes the device should be compensated for the maximum output current expected in the application.

C_{C2}

A second compensation capacitor C_{C2} can be used in some designs to provide a high frequency pole, useful for cancelling a possible zero introduced by the ESR of the output capacitor. For the LM20143 evaluation board, the C_{C2} footprint is unpopulated, as the low ESR ceramic capacitor used on the output does not contribute a zero to the control loop before the crossover frequency. If the ceramic capacitor on the evaluation board is replaced with a different capacitor having significant ESR, the required value of the capacitor C_{C2} can be estimated by the equation:

$$C_{C2} = \frac{C_{OUT} \times R_{ESR}}{R_{C1}}$$

R_T

The value for R_T will set the operating frequency of the device. For this evaluation board a value of 49.9 k Ω was chosen which sets oscillator frequency to 1.5 MHz. The value of R_T can be adjusted to support operating frequencies from 500 kHz to 1.5 MHz by using the equation:

$$R_T = \left(\frac{154750}{f_{SW}} \right) - 55$$

Where, f_{SW} is the switching frequency in kHz, and R_T is the frequency adjust resistor in k Ω .

R_{FB1} and R_{FB2}

The resistors labeled R_{FB1} and R_{FB2} create a voltage divider from V_{OUT} to the feedback pin that is used to set the output of the voltage regulator. Nominally, the output of the LM20143 evaluation board is set to 1.2V, giving resistor values of $R_{FB1} = 4.99$ k Ω and $R_{FB2} = 10$ k Ω . If a different output voltage is required, the value of R_{FB1} can be adjusted according to the equation:

$$R_{FB1} = \left(\frac{V_{OUT}}{0.8} - 1 \right) \times R_{FB2}$$

R_{FB2} does not need to be changed from its value of 10 k Ω .

PCB Layout

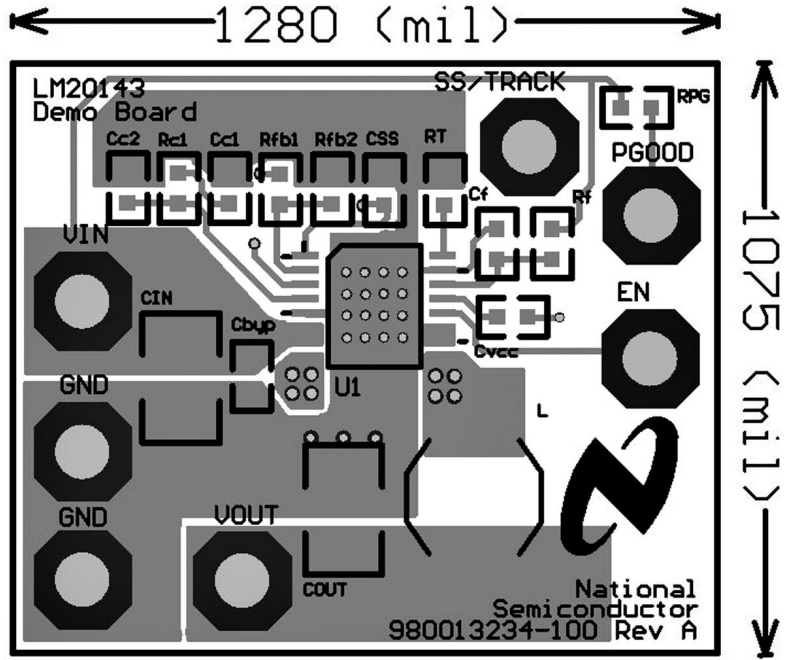

Top Layer

30032913

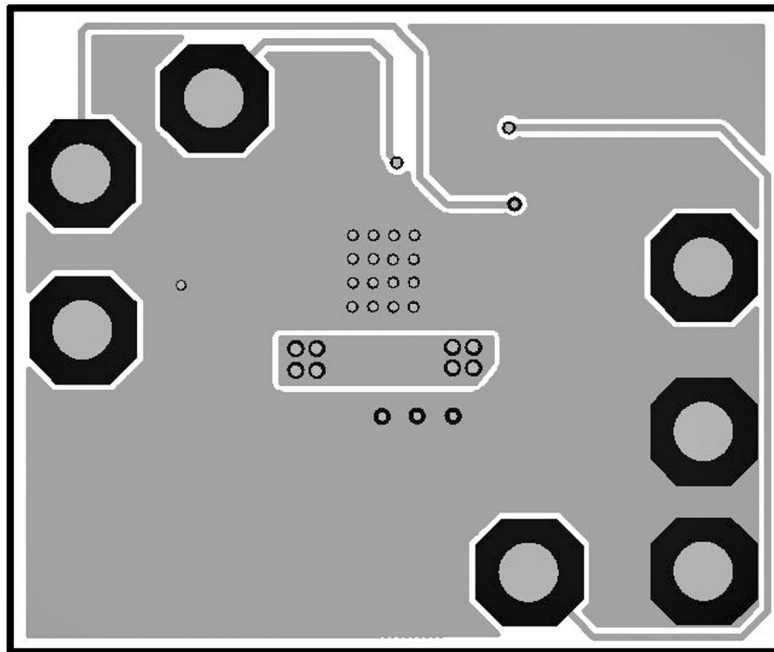

30032914

Notes

AN-1691

Notes

For more National Semiconductor product information and proven design tools, visit the following Web sites at:

Products		Design Support	
Amplifiers	www.national.com/amplifiers	WEBENCH	www.national.com/webench
Audio	www.national.com/audio	Analog University	www.national.com/AU
Clock Conditioners	www.national.com/timing	App Notes	www.national.com/appnotes
Data Converters	www.national.com/adc	Distributors	www.national.com/contacts
Displays	www.national.com/displays	Green Compliance	www.national.com/quality/green
Ethernet	www.national.com/ethernet	Packaging	www.national.com/packaging
Interface	www.national.com/interface	Quality and Reliability	www.national.com/quality
LVDS	www.national.com/lvds	Reference Designs	www.national.com/refdesigns
Power Management	www.national.com/power	Feedback	www.national.com/feedback
Switching Regulators	www.national.com/switchers		
LDOs	www.national.com/ldo		
LED Lighting	www.national.com/led		
PowerWise	www.national.com/powerwise		
Serial Digital Interface (SDI)	www.national.com/sdi		
Temperature Sensors	www.national.com/tempsensors		
Wireless (PLL/VCO)	www.national.com/wireless		

THE CONTENTS OF THIS DOCUMENT ARE PROVIDED IN CONNECTION WITH NATIONAL SEMICONDUCTOR CORPORATION ("NATIONAL") PRODUCTS. NATIONAL MAKES NO REPRESENTATIONS OR WARRANTIES WITH RESPECT TO THE ACCURACY OR COMPLETENESS OF THE CONTENTS OF THIS PUBLICATION AND RESERVES THE RIGHT TO MAKE CHANGES TO SPECIFICATIONS AND PRODUCT DESCRIPTIONS AT ANY TIME WITHOUT NOTICE. NO LICENSE, WHETHER EXPRESS, IMPLIED, ARISING BY ESTOPPEL OR OTHERWISE, TO ANY INTELLECTUAL PROPERTY RIGHTS IS GRANTED BY THIS DOCUMENT.

TESTING AND OTHER QUALITY CONTROLS ARE USED TO THE EXTENT NATIONAL DEEMS NECESSARY TO SUPPORT NATIONAL'S PRODUCT WARRANTY. EXCEPT WHERE MANDATED BY GOVERNMENT REQUIREMENTS, TESTING OF ALL PARAMETERS OF EACH PRODUCT IS NOT NECESSARILY PERFORMED. NATIONAL ASSUMES NO LIABILITY FOR APPLICATIONS ASSISTANCE OR BUYER PRODUCT DESIGN. BUYERS ARE RESPONSIBLE FOR THEIR PRODUCTS AND APPLICATIONS USING NATIONAL COMPONENTS. PRIOR TO USING OR DISTRIBUTING ANY PRODUCTS THAT INCLUDE NATIONAL COMPONENTS, BUYERS SHOULD PROVIDE ADEQUATE DESIGN, TESTING AND OPERATING SAFEGUARDS.

EXCEPT AS PROVIDED IN NATIONAL'S TERMS AND CONDITIONS OF SALE FOR SUCH PRODUCTS, NATIONAL ASSUMES NO LIABILITY WHATSOEVER, AND NATIONAL DISCLAIMS ANY EXPRESS OR IMPLIED WARRANTY RELATING TO THE SALE AND/OR USE OF NATIONAL PRODUCTS INCLUDING LIABILITY OR WARRANTIES RELATING TO FITNESS FOR A PARTICULAR PURPOSE, MERCHANTABILITY, OR INFRINGEMENT OF ANY PATENT, COPYRIGHT OR OTHER INTELLECTUAL PROPERTY RIGHT.

LIFE SUPPORT POLICY

NATIONAL'S PRODUCTS ARE NOT AUTHORIZED FOR USE AS CRITICAL COMPONENTS IN LIFE SUPPORT DEVICES OR SYSTEMS WITHOUT THE EXPRESS PRIOR WRITTEN APPROVAL OF THE CHIEF EXECUTIVE OFFICER AND GENERAL COUNSEL OF NATIONAL SEMICONDUCTOR CORPORATION. As used herein:

Life support devices or systems are devices which (a) are intended for surgical implant into the body, or (b) support or sustain life and whose failure to perform when properly used in accordance with instructions for use provided in the labeling can be reasonably expected to result in a significant injury to the user. A critical component is any component in a life support device or system whose failure to perform can be reasonably expected to cause the failure of the life support device or system or to affect its safety or effectiveness.

National Semiconductor and the National Semiconductor logo are registered trademarks of National Semiconductor Corporation. All other brand or product names may be trademarks or registered trademarks of their respective holders.

Copyright© 2007 National Semiconductor Corporation

For the most current product information visit us at www.national.com



**National Semiconductor
Americas Customer
Support Center**
Email:
new.feedback@nsc.com
Tel: 1-800-272-9959

**National Semiconductor Europe
Customer Support Center**
Fax: +49 (0) 180-530-85-86
Email: europe.support@nsc.com
Deutsch Tel: +49 (0) 69 9508 6208
English Tel: +49 (0) 870 24 0 2171
Français Tel: +33 (0) 1 41 91 8790

**National Semiconductor Asia
Pacific Customer Support Center**
Email: ap.support@nsc.com

**National Semiconductor Japan
Customer Support Center**
Fax: 81-3-5639-7507
Email: jpn.feedback@nsc.com
Tel: 81-3-5639-7560

IMPORTANT NOTICE

Texas Instruments Incorporated and its subsidiaries (TI) reserve the right to make corrections, modifications, enhancements, improvements, and other changes to its products and services at any time and to discontinue any product or service without notice. Customers should obtain the latest relevant information before placing orders and should verify that such information is current and complete. All products are sold subject to TI's terms and conditions of sale supplied at the time of order acknowledgment.

TI warrants performance of its hardware products to the specifications applicable at the time of sale in accordance with TI's standard warranty. Testing and other quality control techniques are used to the extent TI deems necessary to support this warranty. Except where mandated by government requirements, testing of all parameters of each product is not necessarily performed.

TI assumes no liability for applications assistance or customer product design. Customers are responsible for their products and applications using TI components. To minimize the risks associated with customer products and applications, customers should provide adequate design and operating safeguards.

TI does not warrant or represent that any license, either express or implied, is granted under any TI patent right, copyright, mask work right, or other TI intellectual property right relating to any combination, machine, or process in which TI products or services are used. Information published by TI regarding third-party products or services does not constitute a license from TI to use such products or services or a warranty or endorsement thereof. Use of such information may require a license from a third party under the patents or other intellectual property of the third party, or a license from TI under the patents or other intellectual property of TI.

Reproduction of TI information in TI data books or data sheets is permissible only if reproduction is without alteration and is accompanied by all associated warranties, conditions, limitations, and notices. Reproduction of this information with alteration is an unfair and deceptive business practice. TI is not responsible or liable for such altered documentation. Information of third parties may be subject to additional restrictions.

Resale of TI products or services with statements different from or beyond the parameters stated by TI for that product or service voids all express and any implied warranties for the associated TI product or service and is an unfair and deceptive business practice. TI is not responsible or liable for any such statements.

TI products are not authorized for use in safety-critical applications (such as life support) where a failure of the TI product would reasonably be expected to cause severe personal injury or death, unless officers of the parties have executed an agreement specifically governing such use. Buyers represent that they have all necessary expertise in the safety and regulatory ramifications of their applications, and acknowledge and agree that they are solely responsible for all legal, regulatory and safety-related requirements concerning their products and any use of TI products in such safety-critical applications, notwithstanding any applications-related information or support that may be provided by TI. Further, Buyers must fully indemnify TI and its representatives against any damages arising out of the use of TI products in such safety-critical applications.

TI products are neither designed nor intended for use in military/aerospace applications or environments unless the TI products are specifically designated by TI as military-grade or "enhanced plastic." Only products designated by TI as military-grade meet military specifications. Buyers acknowledge and agree that any such use of TI products which TI has not designated as military-grade is solely at the Buyer's risk, and that they are solely responsible for compliance with all legal and regulatory requirements in connection with such use.

TI products are neither designed nor intended for use in automotive applications or environments unless the specific TI products are designated by TI as compliant with ISO/TS 16949 requirements. Buyers acknowledge and agree that, if they use any non-designated products in automotive applications, TI will not be responsible for any failure to meet such requirements.

Following are URLs where you can obtain information on other Texas Instruments products and application solutions:

Products

Audio	www.ti.com/audio
Amplifiers	amplifier.ti.com
Data Converters	dataconverter.ti.com
DLP® Products	www.dlp.com
DSP	dsp.ti.com
Clocks and Timers	www.ti.com/clocks
Interface	interface.ti.com
Logic	logic.ti.com
Power Mgmt	power.ti.com
Microcontrollers	microcontroller.ti.com
RFID	www.ti-rfid.com
OMAP Mobile Processors	www.ti.com/omap
Wireless Connectivity	www.ti.com/wirelessconnectivity

Applications

Communications and Telecom	www.ti.com/communications
Computers and Peripherals	www.ti.com/computers
Consumer Electronics	www.ti.com/consumer-apps
Energy and Lighting	www.ti.com/energy
Industrial	www.ti.com/industrial
Medical	www.ti.com/medical
Security	www.ti.com/security
Space, Avionics and Defense	www.ti.com/space-avionics-defense
Transportation and Automotive	www.ti.com/automotive
Video and Imaging	www.ti.com/video

TI E2E Community Home Page

e2e.ti.com

Mailing Address: Texas Instruments, Post Office Box 655303, Dallas, Texas 75265
Copyright © 2011, Texas Instruments Incorporated