

Round Red Through-hole LED Lamp (5 mm)

OVLFR3C7

- High brightness with well-defined spatial radiation patterns
- UV-resistant epoxy lens
- Red (624 nm)

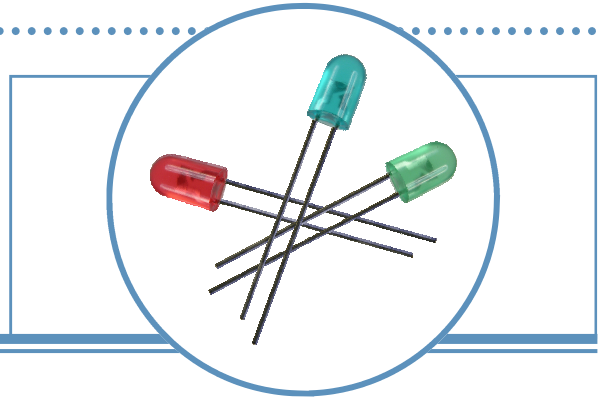

The **OVLFR3C7** is a high-intensity AlInGaP LED mounted in a clear plastic T-1¼ package. Its UV-resistant epoxy lens makes this device an optimal solution for outdoor applications. This LED provides a well-defined and even emission pattern.

Applications

- Traffic and pedestrian signals
- Signage and architectural lighting
- Backlighting
- Automotive

Part Number	Material	Emitted Color	Intensity Typ. (mcd)	Lens Color
OVLFR3C7	AlInGaP	Red	5000	Water Clear

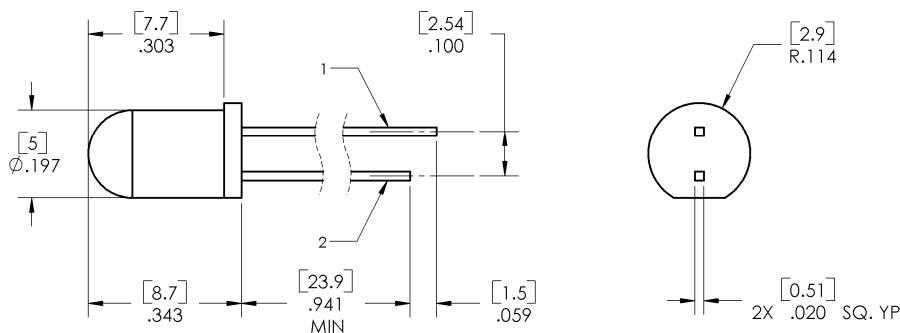

1 ANODE 2 CATHODE DIMENSIONS ARE IN INCHES AND [MILLIMETERS].



DO NOT LOOK DIRECTLY AT LED WITH UNSHIELDED EYES OR DAMAGE TO RETINA MAY OCCUR.

OPTEK reserves the right to make changes at any time in order to improve design and to supply the best product possible.

Round Red Through-hole LED (5 mm)

OVLFR3C7



Absolute Maximum Ratings

$T_A = 25^\circ\text{C}$ unless otherwise noted

Storage Temperature Range	-40 ~ +100 °C
Operating Temperature Range	-40 ~ +85 °C
Reverse Voltage	5 V
Continuous Forward Current ²	30 mA
Peak Forward Current (10% Duty Cycle, 1KHz)	100 mA
Power Dissipation	100 mW
Lead Soldering Temperature (3mm from the base of the epoxy bulb) ¹	260 °C
Current Linearity vs. Ambient Temperature	-0.5 mA/°C
LED Junction Temperature	125 °C

Notes:

- Solder time less than 5 seconds at temperature extreme.
- Design of heat dissipation should be considered.

Electrical Characteristics

$T_A = 25^\circ\text{C}$ unless otherwise noted

SYMBOL	PARAMETER	MIN	TYP	MAX	UNITS	CONDITIONS
I_V	Luminous Intensity	2820	5000	----	mcd	$I_F = 20 \text{ mA}$
V_F	Forward Voltage	----	2.2	2.6	V	$I_F = 20 \text{ mA}$
I_R	Reverse Current	----	----	10	μA	$V_R = V$
λ_P	Peak Wavelength	----	633	----	nm	$I_F = 20 \text{ mA}$
λ_D	Dominant Wavelength	619	623	630	nm	$I_F = 20 \text{ mA}$
$\Delta\lambda$	Spectra Half Width	----	25	----		
$2\theta_{1/2}$	50% Power Angle	----	30	----	deg	$I_F = 20 \text{ mA}$

Standard Bins ($I_F = 20\text{mA}$)

Lamps are sorted to luminous intensity (I_V) and dominant wavelength (λ_D) bins shown. Orders for OVLFR3C7 may be filled with any or all bins contained as below.

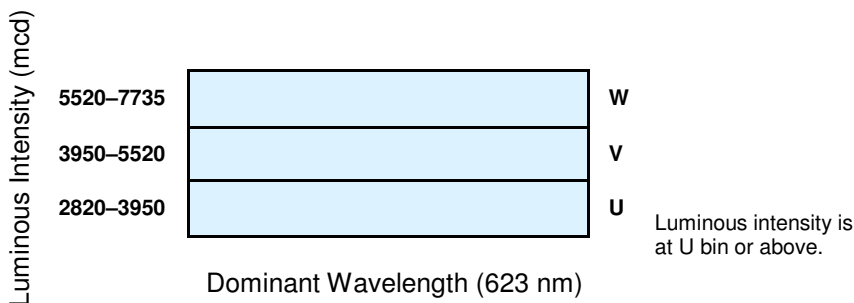

Notes:

- All ranks will be included per delivery, rank ratio will be based on the chip distribution.
- To designate luminous intensity ranks, please contact OPTEK.
- Pb content <1000 PPM.

OPTEK reserves the right to make changes at any time in order to improve design and to supply the best product possible.

Typical Electro-Optical Characteristics Curves

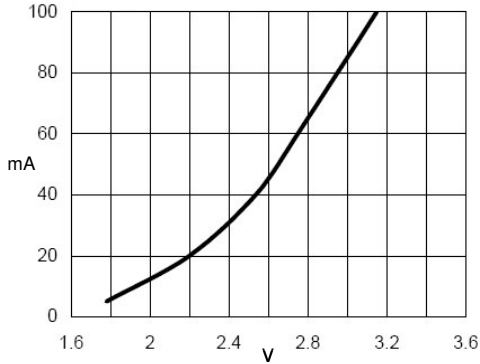

Forward Current vs Forward Voltage

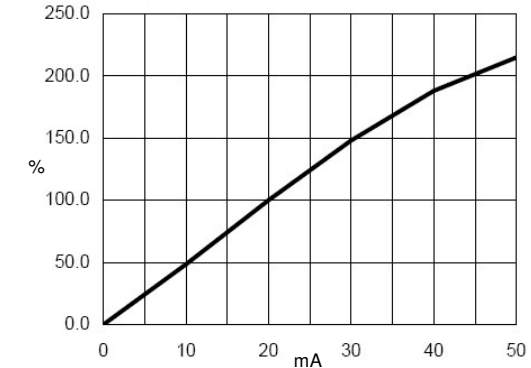

Relative Luminous Intensity vs Forward Current

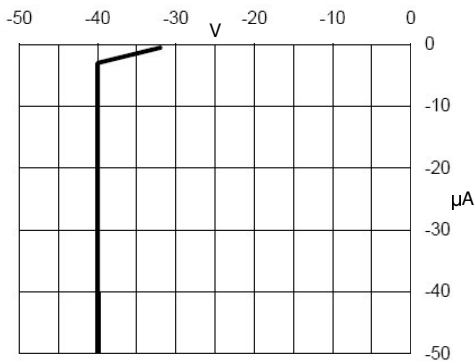

Reverse Current vs Reverse Voltage

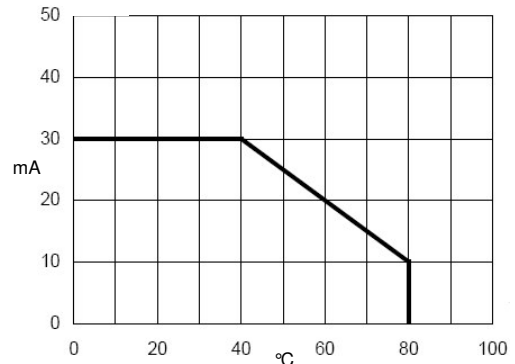

Forward Current vs Ambient Temperature

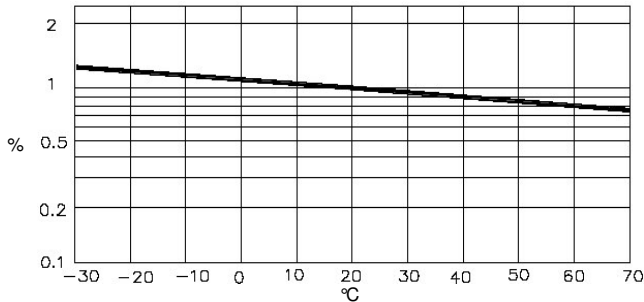

Relative Luminous Intensity vs Ambient Temperature

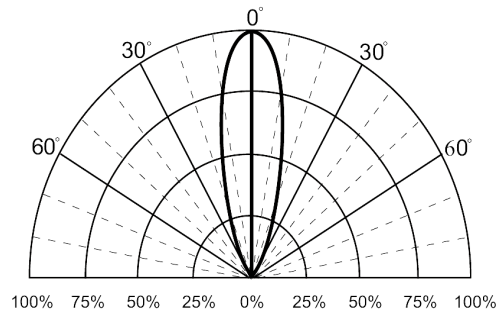

Beam Pattern

OPTEK reserves the right to make changes at any time in order to improve design and to supply the best product possible.

Round Red Through-hole LED (5 mm) OVLFR3C7

Packing Information: Available in bulk or reel

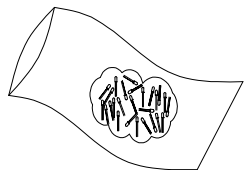

Bulk: 500 pcs/bag

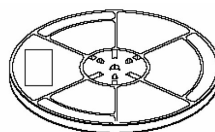

13-inch reel: 1000 pcs/reel

Carrier Tape Dimensions: Loaded quantity 1000 pieces per reel

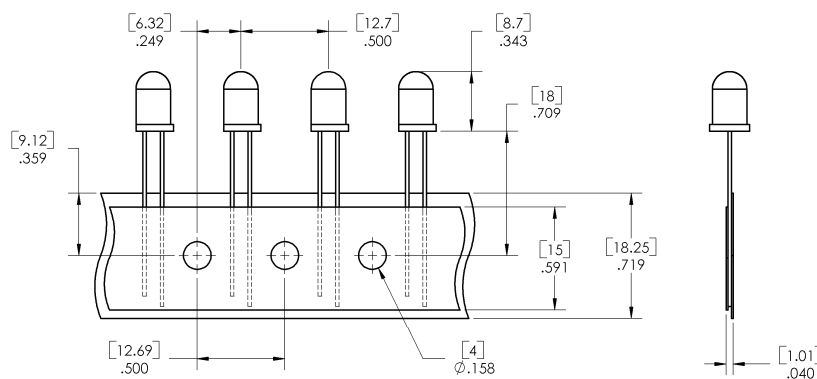

DIMENSIONS ARE IN INCHES AND [MILLIMETERS].

Moisture Resistant Packaging

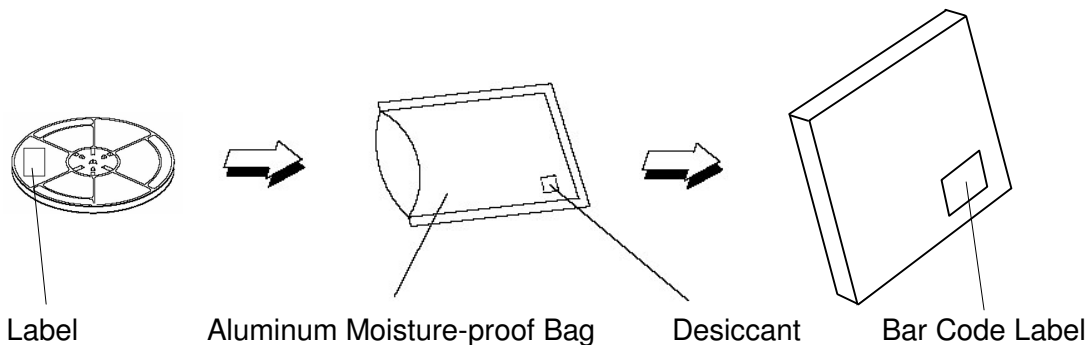

OPTEK reserves the right to make changes at any time in order to improve design and to supply the best product possible.