

SMT POWER INDUCTORS

Power Beads - Volta 1 & 2 Series

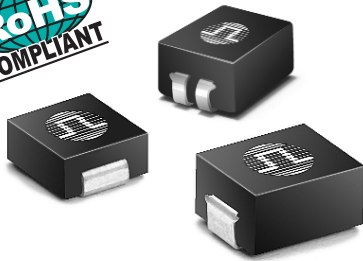

- Height:** 3.2mm and 4.5mm Max
- Footprint:** 7.0 x 6.4mm Max and 8.9 x 6.4mm Max
- Current Rating:** up to 16A
- Inductance Range:** 0.1µH to 0.6µH
- Frequency Range:** up to 2MHz

Electrical Specifications @ 25°C — Operating Temperature -40°C to +130°C

Part ^{5,6} Number	Inductance @Irated (nH ± 20%)	Irated ¹ (ADC)	DCR (mΩ)		Inductance @0A _{DC} (nH ± 20%)	Saturation Current ² (ADC)		Heating ³ Current (A)	Trise ⁴ Factor K0	Core Loss Factor ⁴		
			TYP	MAX		25°C	100°C			K1	K2	
VOLTA 1												
P1681	95	15	0.31	0.39	100	18	16.2	15	1.0032	.00319	.07381	
VOLTA 2												
PA0229	92	16	0.68	0.80	100	36	30	16	2.2458	.00638	.03975	
P2005	142.5	15	0.45	0.56	150	18	16.2	15	2.2458	.00638	.05961	
P2004	190	15	0.45	0.56	200	16.8	15.1	15	2.2458	.00638	.07949	
PA0277	600*	10.7	2.3	2.53*	700	12.6	8.0	10.7	2.0400	.01276	.13196	

* DCR and Inductance rating for indicated parts is for both windings tied in series.

Mechanicals

Schematic

Volta 1

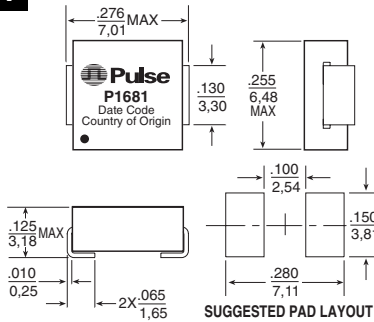

Volta 1 **Volta 2**
Weight.....0.464 grams0.945 grams
Tape & Reel1500/reel1000/reel

Dimensions: Inches
mm
Unless otherwise specified,
all tolerances are ± .010
0,25

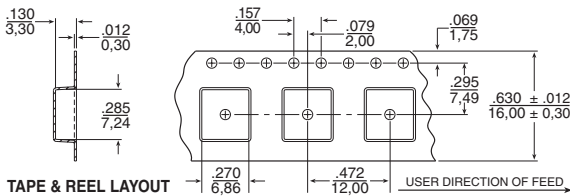

Volta 2

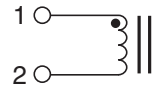
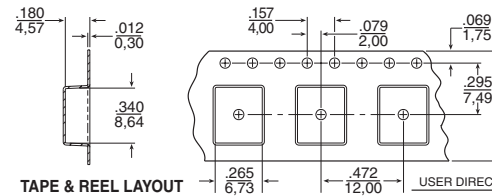
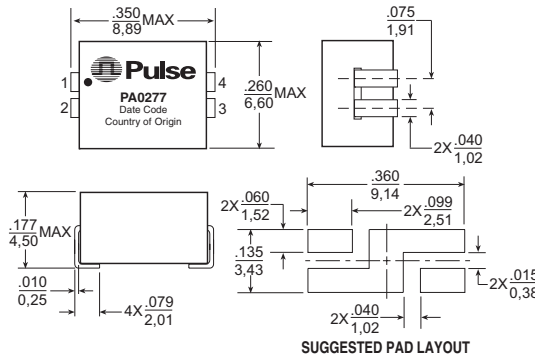
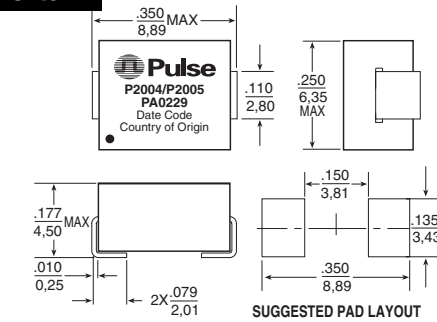

P1681
P2004
P2005
PA0229

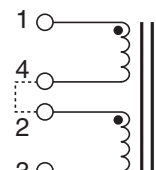

PA0277

SMT POWER INDUCTORS

Power Beads - Volta 1 & 2 Series



Notes from Tables

1. The rated current as listed is either the saturation current or the heating current depending on which value is lower.
2. The saturation current is the current which causes the inductance to drop by 10% at the stated ambient temperatures (-40°C, 25°C, 125°C). This current is determined by placing the component in the specified ambient environment and applying a short duration pulse current (to eliminate self-heating effects) to the component.
3. The heating current is the DC current which causes the temperature of the part to increase by approximately 30°C. This current is determined by mounting the component on a PCB with .25" wide, 3 oz. equivalent copper traces, and applying the current to the device for 30 minutes.
4. In high volt*time applications, additional heating in the component can occur due to core losses in the inductor which may necessitate derating the current in order to limit the temperature rise of the component. In order to determine the approximate total losses (or temperature rise) for a given application both copper losses and core losses should be taken into account.

5. Optional Tape & Reel packaging can be ordered by adding a "T" suffix to the part number, (i.e. PA0277T).
6. To order RoHS compliant part, add the suffix "NL" to the part number (i.e. PA0277 becomes PA0277NL and PA0277T becomes PA0277NLT).

Estimated Temperature Rise:

$$Trise = \left[\frac{Coreloss (mW) + Copper Loss (mW)}{KO} \right]^{.833} \quad (^{\circ}C)$$

$$Coreloss = KI * (Fsw(kHz))^{1.6688} * (K2 * dI)^{2.17} (mW)$$

$$Copper Loss = Irms^2 * DCR(m\Omega) (mW)$$

$$Irms = \left[IDC^2 + \left[\frac{dI}{12} \right]^2 \right]^{1/2} (Arms)$$

$$Fsw(kHz) = \text{switching frequency (kHz)}$$

$$dI = \text{delta I across the component (A)}$$

The temperature of the component (ambient temperature + temperature rise) should be within the listed operating temperature range.

Inductance vs Current Characteristics
P1681, P2005, P2004

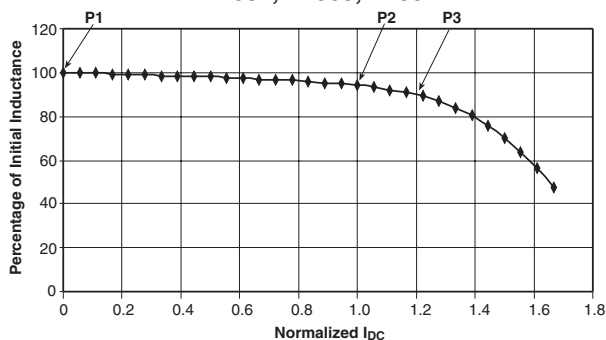

P1 - Initial Inductance, Lo (.1VRMS, 1MHz, 0Adc, 25°C)

P2 - Inductance (typically 95% Lo) at Rated Idc.

P3 - Inductance (typically 90% Lo) at Idc.

◆ Normalized Inductance

PA0229 Inductance vs. DC Current at 25°C

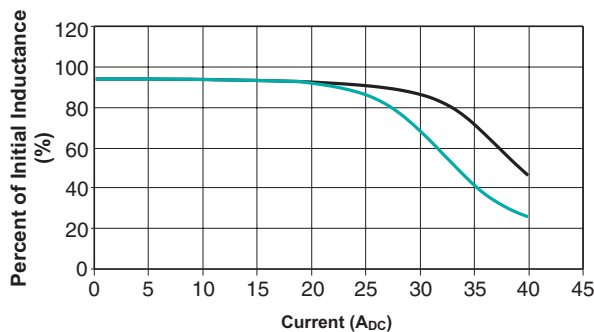

— 25°C — 100°C

PA0277 Inductance vs. DC Current at 25°C

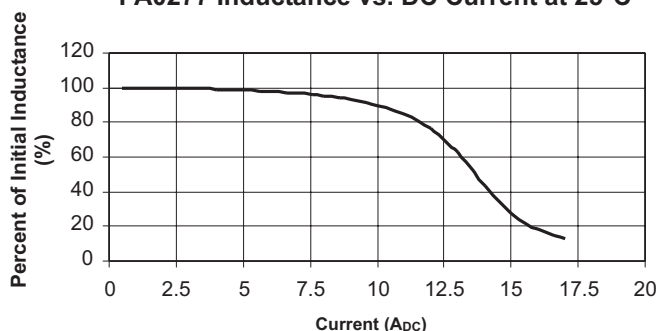

For More Information:

Pulse Worldwide Headquarters

12220 World Trade Drive
San Diego, CA 92128
U.S.A.

www.pulseeng.com

TEL: 858 674 8100

FAX: 858 674 8262

Pulse Northern Europe

3 Huxley Road
Surrey Research Park
Guildford, Surrey GU2 5RE
United Kingdom

TEL: 44 1483 401700

FAX: 44 1483 401701

Pulse Southern Europe

Zone Industrielle
F-39270
Orgelet
France

TEL: 33 3 84 35 04 04

FAX: 33 3 84 25 46 41

Pulse China Headquarters

No. 1
Industrial District
Changan, Dongguan
China

TEL: 86 769 85538070

FAX: 86 769 85538870

Pulse North China

Room 1503
XinYin Building
No. 888 YiShan Road
Shanghai 200233
China

TEL: 86 21 54643211/2

FAX: 86 21 54643210

Pulse South Asia

150 Kampong Ampat
#07-01/02
KA Centre
Singapore 368324

TEL: 65 6287 8998

FAX: 65 6280 0080

Pulse North Asia

No. 26
Kao Ching Road
Yang Mei Chen
Taoyuan Hsien
Taiwan, R. O. C.

TEL: 886 3 4641811

FAX: 886 3 4641911

Performance warranty of products offered on this data sheet is limited to the parameters specified. Data is subject to change without notice. Other brand and product names mentioned herein may be trademarks or registered trademarks of their respective owners.

© Copyright, 2006. Pulse Engineering, Inc. All rights reserved.