

Mini HDMI Socket

Type C, SMT



Specifications:



Connector Type	: Mini HDMI
Gender	: Receptacle
No. of Rows	: 1
No. of Contacts	: 19
Contact Termination	: Solder
Contact Plating	: Gold
Contact Material	: Brass
Colour	: Black
Lead Spacing	: 0.4mm
Maximum operating current	: 0.5A
Operating temperature	: -25°C to +85°C
Dielectric withstanding voltage	: 500V AC between adjacent terminal (unmate) 300V AC between adjacent terminal (mate)
Minimum insulation resistance	: 100MΩ (unmate) 10MΩ (mate)

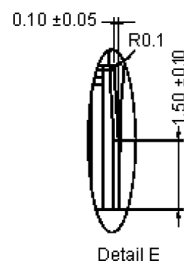
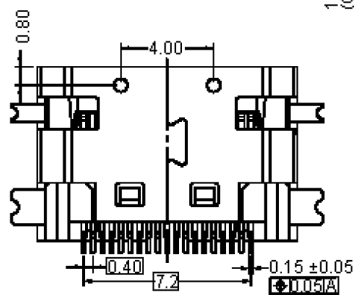
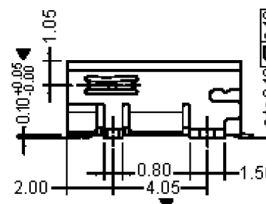
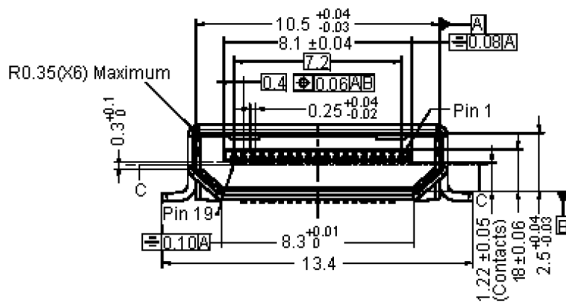
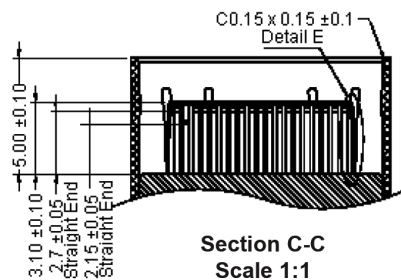
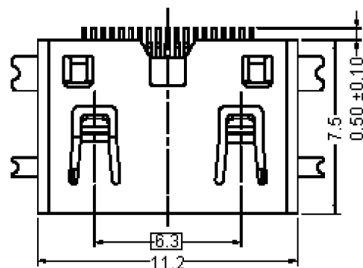

Dimensions : Millimetres



Mini HDMI Socket

Type C, SMT

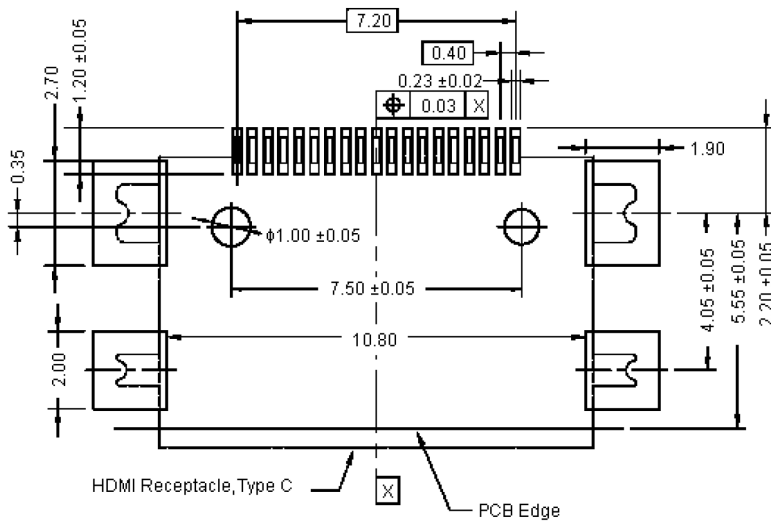

Recommended PCB Layout

Dimensions : Millimetres

Part Number Table

Description	Part Number
Socket, Mini HDMI, SMT	60U019S-342N-B1-FEC

Important Notice : This data sheet and its contents (the "Information") belong to the members of the Premier Farnell group of companies (the "Group") or are licensed to it. No licence is granted for the use of it other than for information purposes in connection with the products to which it relates. No licence of any intellectual property rights is granted. The Information is subject to change without notice and replaces all data sheets previously supplied. The Information supplied is believed to be accurate but the Group assumes no responsibility for its accuracy or completeness, any error in or omission from it or for any use made of it. Users of this data sheet should check for themselves the Information and the suitability of the products for their purpose and not make any assumptions based on information included or omitted. Liability for loss or damage resulting from any reliance on the Information or use of it (including liability resulting from negligence or where the Group was aware of the possibility of such loss or damage arising) is excluded. This will not operate to limit or restrict the Group's liability for death or personal injury resulting from its negligence. Multicomp is the registered trademark of the Group. © Premier Farnell plc 2012.

www.element14.com
 www.farnell.com
 www.newark.com

