

RotorFlow® Sensors Provide Visual Indication, Continuous Sensing and Accurate Switching

- ▶ Bright, visual indication with choice of pulsed DC output, or adjustable 1 amp switched output
- ▶ Flow ranges from .1 GPM to 60.0 GPM
- ▶ Compact inline housings
- ▶ Available in high performance plastic, brass, or stainless steel housings

Determined to provide you with the most versatile line of flow sensors available, we've continued a non-stop refinement process for the entire RotorFlow® Series. GEMS new generation of RotorFlow® sensors, the RF-2500 Series, have been totally re-engineered with a one piece composite rotor, stronger unibody construction, ceramic shaft and better sealing. The results are greater durability with broader chemical, temperature and pressure capabilities.

Today's RotorFlow Series is state-of-the-art and offers more options, better performance and durability than ever before...all at an affordable price geared for high volume, OEM applications.

Select the RotorFlow sensor that is right for your application by choosing one of our three distinct configurations. You'll find details on each of these configurations inside.

RotorFlow Switch Types

For specific flow setpoint switching, RotorFlow RFS type switches are one of the most reliable flow switches available. Setpoints are fully adjustable over the specified flow range. The dynamic operation of the rotor guards against jamming and false actuation.

RotorFlow Output Types

For flow rate monitoring or metering applications. RotorFlow RFO Type sensors provide a pulsed DC voltage output that is proportional to the rate of flow. The operating range of 4.5 to 24 VDC pulsed output is easily integrated into most digital logic units. RFA Type RotorFlow sensors provide a continuous 0-10 VDC analog output.

RotorFlow Indicator Types

For those who want simple visual confirmation of flow, RotorFlow RFI indicators provide the durable, low-cost answer. A bright, orange spinning rotor provides visual flow confirmation at a glance.



RotorFlow Series Sensors are U.L. Recognized — File No. E45168.

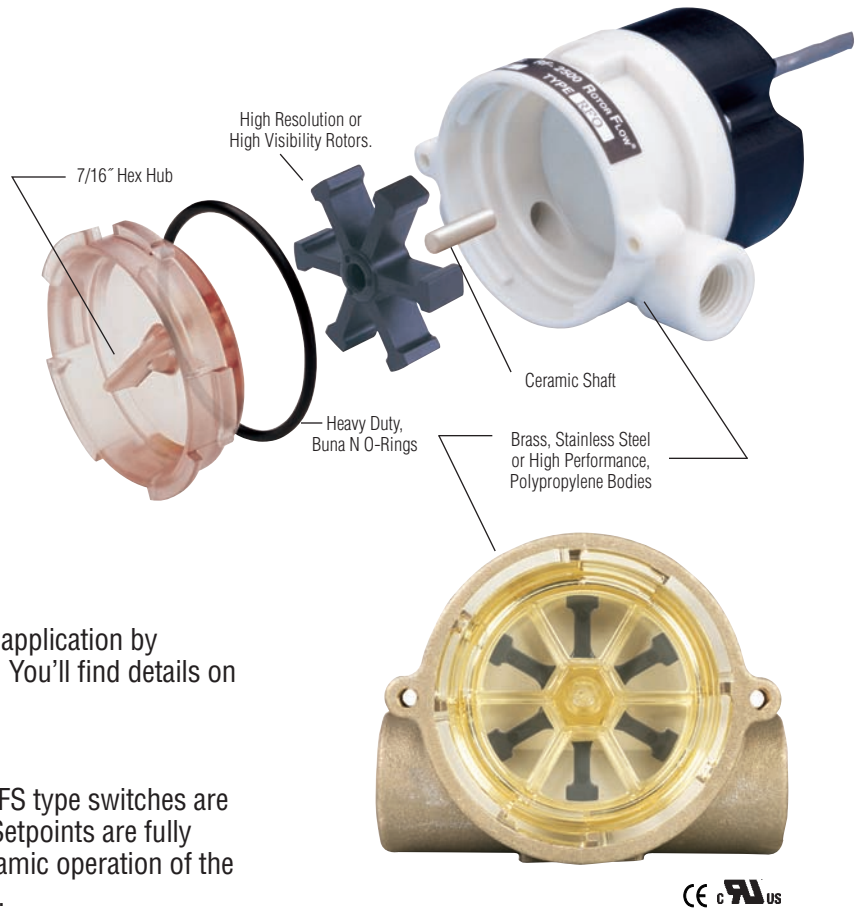

Now for line sizes up to 1"



New wide-body senses flow up to 60 GPM. 3/4" and 1" line models.



Flow Set Point Switching – RFS Types

- ▶ Combines visual confirmation of flow with dynamic, electronic switch operation
- ▶ Easy, adjustable switch point calibration: a local LED signals when set point is reached

RotorFlow® Switches build an extra level of reliability and protection into your equipment. By principle of operation, the rotor cannot be deceived into indicating a positive flow situation when no flow actually exists. Once set to a desired actuation point, RotorFlow will switch to a “no-flow” condition should the rotor stop for any reason.

Typical Applications

Protect expensive electronic equipment from coolant flow failure on...

- Semiconductor Processing Equipment
- Lasers • Medical Equipment
- X-Ray and Other High Power Tubes
- Robotic Welding Equipment



File No. E45168



Specifications

Wetted Materials	Brass, 316 Stainless Steel or Polypropylene (Hydrolytically Stable, Glass Reinforced)	
Body		
Rotor Pin	Ceramic	
Rotor	PPS Composite, Black	
Lens	Polysulfone	
O-Ring	Viton® (Alloy Bodies); Buna N (Polypropylene Body)	
Low Flow Adaptor	Glass Reinforced Polypropylene	
Operating Pressure, Maximum	200 PSIG (13.8 bar) @ 70°F (21°C), 100 PSIG (6.9 bar) Max. @ 212°F (100°C) ¹	
Brass or Stainless Steel Body		
Polypropylene Body	100 PSIG (6.9 bar) @ 70°F (21°C), 40 PSI (2.8 bar) Max. @ 180°F (82°C)	
Operating Temperature, Brass or Stainless Steel Body	-20°F to 212°F (-29°C to 100°C)	
Polypropylene Body	-20°F to 180°F (-29°C to 82°C)	
Electronics	150°F (65°C) Ambient	
Viscosity, Maximum	200 SSU	
Input Power	24 VDC or 115 VAC	
Relay Contact Ratings (SPDT)	1 Amp, 24 VDC Resistive; 0.3 Amp, 110 VAC	
Current Consumption	No Load	Load (Relay Energized)
24 VDC	20mA	35mA
115 VAC	45mA	95mA
Repeatability	2% Maximum Deviation	
Set Point Accuracy (Factory Set)	± 5%	
Set Point Differential	15% Maximum	
Electrical Termination	20 AWG PVC-Jacketed, 24" Cable. Color Codes: Red = +VAC/VDC, Black = Ground, White = N.O. Contact, Brown = N.C. Contact, Green = Common	

Note:
1. Optional pulsed output available with RFS. Consult factory.

Dimensions

Polypropylene Bodies

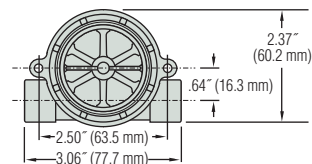

VDC

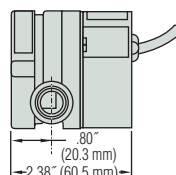

VAC

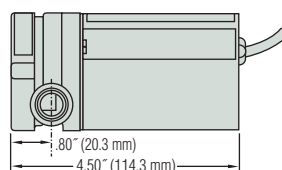

Brass and Stainless Steel Bodies - .25" and .50" Port

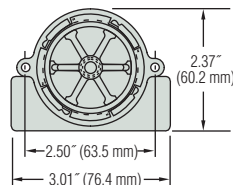

VDC

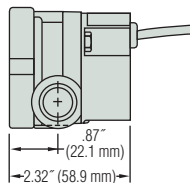

VAC

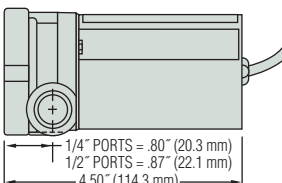

Brass and Stainless Steel Bodies - .75" and 1.00" Port

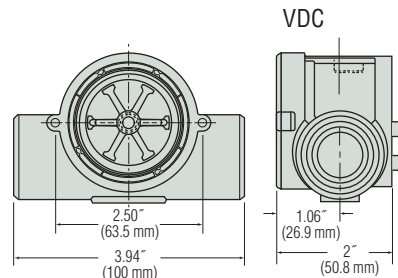

VDC

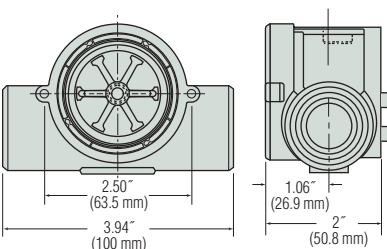

VAC

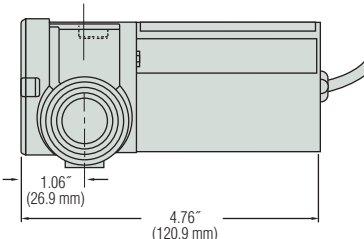

Switch Set Point Calibration With LED Signal (RFS Type)

With the unit installed in the line and power supplied, complete the following steps to calibrate switch actuation point with proper flow rate. A small flat-blade screwdriver is the only tool required.

1. Adjust liquid flow in the line to the rate at which switch actuation is desired.
2. Insert screwdriver into opening on backside of housing and fit blade into the potentiometer adjustment screw inside.
3. If LED is not illuminated, slowly turn screwdriver counterclockwise and stop as soon as LED illuminates.
4. If LED is illuminated, turn screwdriver clockwise until LED light goes out. Then, slowly turn screwdriver counterclockwise and stop as soon as LED illuminates.

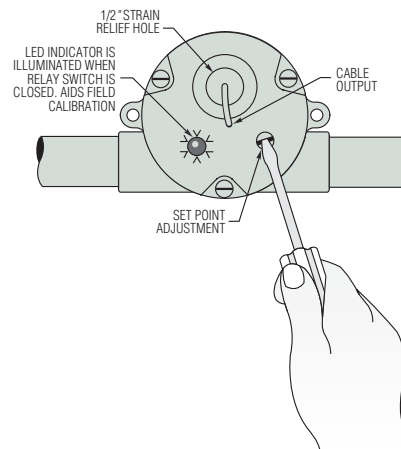

How To Order

Specify Part Number based on desired body material, port size and input power rating.

Body Material	Port Size NPT	Flow Ranges – GPM		Input Power	Part Number		
		Low Range*	Standard Range				
Polypropylene	.25"	0.1 to 1.0	0.5 to 5.0	24 VDC	155425 ⚡		
				115 VAC	155876 ⚡		
	.50"	1.5 to 12.0	4.0 to 20.0	24 VDC	155485 ⚡		
				115 VAC	155886 ⚡		
Brass	.25"	0.1 to 1.0	0.5 to 5.0	24 VDC	156265 ⚡		
				115 VAC	156266 ⚡		
	.50"	1.5 to 12.0	4.0 to 20.0	24 VDC	156268 ⚡		
				115 VAC	156269 ⚡		
	.75"	–	5.0 to 30.0	24 VDC	180395 ⚡		
				115 VAC	180396 ⚡		
	1.00"	–	8.0 to 60.0	24 VDC	181688 ⚡		
				115 VAC	181689 ⚡		
9/16-18**				0.1 to 1.0	0.5 to 5.0	24 VDC	165073 ⚡
						115 VAC	165074 ⚡
Stainless Steel	.50"	1.5 to 12.0	4.0 to 20.0	24 VDC	165077 ⚡		
				115 VAC	165078 ⚡		
	.75"	–	5.0 to 30.0	24 VDC	181691 ⚡		
				115 VAC	181692 ⚡		
1.00"	–	8.0 to 60.0	24 VDC	181693 ⚡			
			115 VAC	181694 ⚡			

* With use of Low Flow Adapter supplied. See Page F-8 for more information.
 ** Straight thread with O-ring seal.

⚡ – Stock Items.

Special Requirements:

GEMS caters to OEM needs with special configurations for potable water and enhanced chemical capabilities. Consult factory for further details.

For higher pressure/temperature ratings, stainless face plates are available. Consult factory.

High Resolution Black Rotor
 PPS composite. Each of the six rotor arms is magnetized. A PTFE loaded bushing ensures long life.



Pressure Drop-Typical

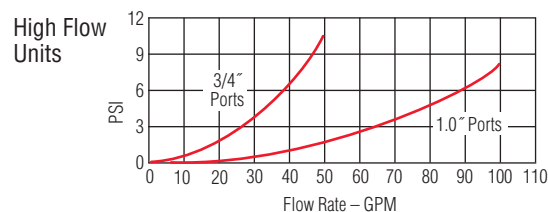
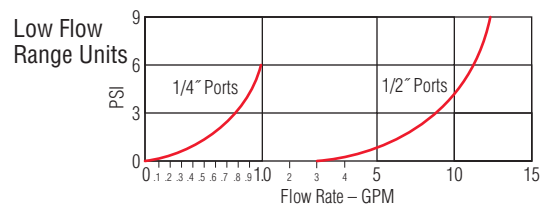
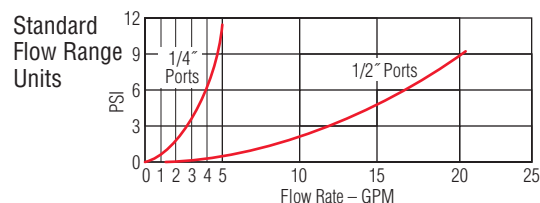

Flow Rate Monitoring – RFO Type

► 4.5 to 24 VDC Pulsed Output

GEMS Sensors popularized the RotorFlow's paddlewheel design by combining high visibility rotors with solid-state electronics that are packaged into compact, panel mounting housings. They provide accurate flow rate output with integral visual confirmation...all with an unprecedented price/performance ratio. RFO Types feature a VDC pulsed output.

Typical Applications

- Water Purification/Dispensing Systems • Chemical Metering Equipment
- Lasers and Welders • Water Injection Systems
- Semiconductor Processing Equipment • Chillers and Heat Exchangers

Specifications

Wetted Materials	
Body	Brass, 316 Stainless Steel or Polypropylene (Hydrolytically Stable, Glass Reinforced)
Rotor Pin	Ceramic
Rotor	PPS Composite, Black
Lens	Polysulfone ¹
O-Ring	Viton® (Alloy Bodies); Buna N (Polypropylene Body)
Low Flow Adaptor	Glass Reinforced Polypropylene
Operating Pressure, Maximum	
Brass or Stainless Steel Body	Optional SS Face Plate 500 PSIG 200 PSIG (13.8 bar) @ 70°F (21°C), 100 PSI (6.9 bar) Max. @ 212°F (100°C) ¹
Polypropylene Body	100 PSIG (6.9 bar) @ 70°F (21°C), 40 PSI (2.8 bar) Max. @ 180°F (82°C)
Operating Temperature	
Brass or Stainless Steel Body	-20°F to 212°F (-29°C to 100°C)
Polypropylene Body	-20°F to 180°F (-29°C to 82°C)
Electronics	150°F (65°C) Ambient
Viscosity, Maximum	200 SSU
Input Power	4.5 VDC to 24 VDC
Output Signal	4.5 VDC to 24 VDC Pulse. (Sourcing) Pulse Rate Dependent on Flow Rate, Port Size and Range.
Current Consumption	8 mA, No Load
Current Source Output, Max.	70 mA
Frequency Output Range	15 Hz (Low Flow) to 225 Hz (High Flow)
Accuracy	See Table Below
Electrical Termination	22 AWG PVC-Jacketed, 24" Cable. Color Coded: Red = +VDC; Black = Ground; White = Signal Output

Notes:

1. For higher pressure/temperature ratings, stainless face plates are available. Consult factory.

How To Order

For standard configurations, specify Part Number based on desired body material and port size.

Body Material	Port Size NPT	Flow Range – GPM		Part Number
		Low Range* (Accuracy)	Standard Range (Accuracy)	
Polypropylene	.25"	0.1 to 1.0 (±7.0%)	0.5 to 5.0 (±7.0%)	155421 ⚡
	.50"	1.5 to 12.0 (±7.0%)	4.0 to 20.0 (±15.0%)	155481 ⚡
Brass	.25"	0.1 to 1.0 (±7.0%)	0.5 to 5.0 (±7.0%)	156261 ⚡
	.50"	1.5 to 12.0 (±7.0%)	4.0 to 20.0 (±15.0%)	156262 ⚡
	.75"	—	5.0 to 30.0 (±15.0%)	194761 ⚡
	1.00"	—	8.0 to 60.0 (±15.0%)	194762 ⚡
Stainless Steel	9/16"~18**	0.1 to 1.0 (±7.0%)	0.5 to 5.0 (±7.0%)	165071 ⚡
	.50"	1.5 to 12.0 (±7.0%)	4.0 to 20.0 (±15.0%)	165075 ⚡
	.75"	—	5.0 to 30.0 (±15.0%)	194763
	1.00"	—	8.0 to 60.0 (±15.0%)	194764

⚡ – Stock Items.



File No. E45168

Dimensions

Polypropylene Bodies

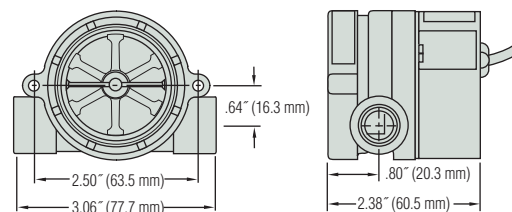

Brass and Stainless Steel Bodies - .25" and .50" Ports

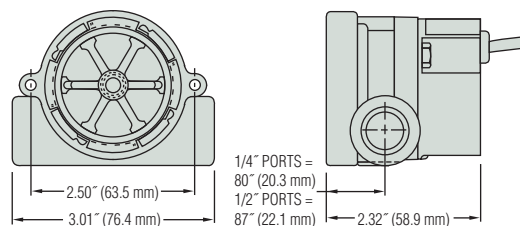

Brass Bodies – .75" and 1.00" NPT Ports

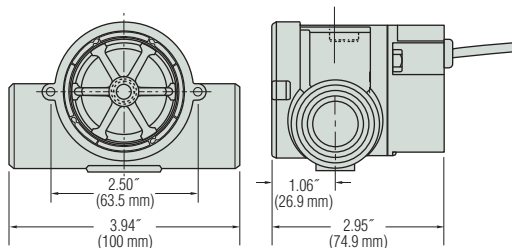

High Resolution

Black Rotor
PPS composite. Each of the six rotor arms is magnetized. A PTFE loaded bushing ensures long life.



Note: Improved accuracy can be achieved by calibrating the individual RFO unit.

*With use of Low Flow Adapter supplied.

See Page F-8 for more information.

**Straight thread with O-ring seal.

Operating Principle

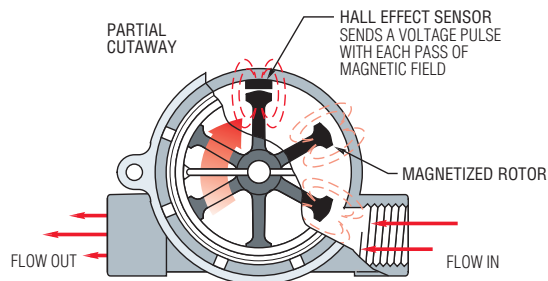

1. As liquid passes through the RotorFlow body, the magnetic rotor spins at a rate proportional to flow. This causes a series of magnetic fields (the rotor vanes) to excite the Hall Effect sensor, producing a series of voltage pulses.
2. The output pulses (RFO) are at the same voltage level as the input (4.5 - 24 VDC) with a frequency proportional to the flow rate. The output signal can be utilized by digital rate meters totalizers or other electronic controllers. RFA Type analog sensors condition the output signal to 0-10 VDC.
3. RotorFlow Indicators may be mounted with flow entering either port. Performance is optimized by positioning ports at the top of the unit, in a horizontal plane.

Frequency vs. Flow Rate-Typical

Flow Rate (GPM)	Output Frequency – Hz					
	RFO Model – Based on Port Size					
	.25"	.25" with Adapter*	.50"	.50" with Adapter*	.75"	1"
0.10		13				
0.25		41				
0.50	15	90				
0.75		137				
1.0	34	186				
1.5	54			17		
2.0	73			25.9		
2.5	90			34		
3.0	110			43		
3.5	128					
4.0	148		34	60		
4.5	168					
5.0	185		44.8	76.7	24	
6.0			55	94		
7.0			65.9	111		
8.0			76	129		22
9.0			87.5	147		
10			99	165	61	30
11			110	185		
12			122	204		
13			135			
14			147			
15			158		93	43
16			170			
17			183			
18			195			
19			207			
20			220		128	60
25					163	74
30					196	91
35						107
40						123
45						137
50						153
55						170
60						185

*Low Flow Adapter

Pressure Drop-Typical

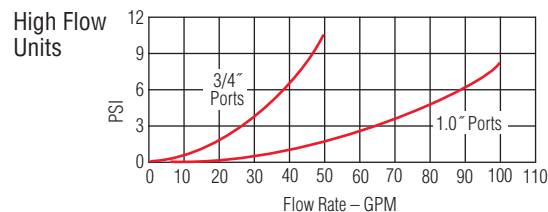
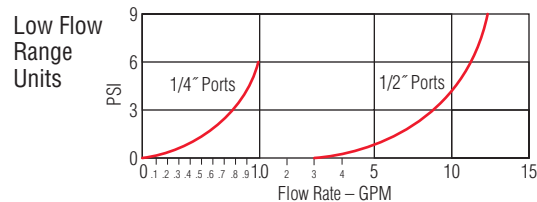
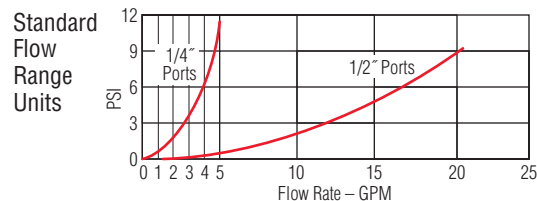

Signal Output

Output signal for RFO Types is an on/off pulse of the DC voltage supplied to the unit, it is compatible with all digital logic families. Input voltage range is 4.5 to 24 VDC. Frequency of the output pulse is proportional to the flow rate and ranges from approximately 15 Hz at low flow to 225 Hz at high flow.

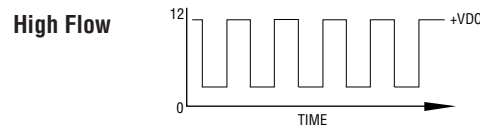
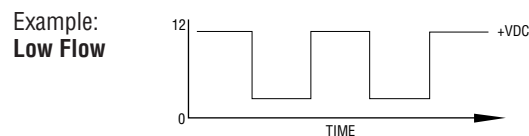

Note: Consult factory for flow rate/frequency curves.

Flow Rate Monitoring – RFA Types

► 0 to 10 VDC Analog Output

GEMS Sensors popularized the RotorFlow's paddlewheel design by combining high visibility rotors with solid-state electronics that are packaged into compact, panel mounting housings. They provide accurate flow rate output with integral visual confirmation...all with an unprecedented price/performance ratio. RFA Types feature a 0 to 10 VDC analog output which is proportional to flow rate.

Specifications

Wetted Materials	
Body	Brass, 316 Stainless Steel or Polypropylene (Hydrolytically Stable, Glass Reinforced)
Rotor Pin	Ceramic
Rotor	PPS Composite, Black ¹
Lens	Polysulfone
O-Ring	Viton® (Alloy Bodies); Buna N (Polypropylene Body)
Low Flow Adaptor	Glass Reinforced Polypropylene
Operating Pressure, Maximum	
Brass or Stainless Steel Body	200 PSIG (13.8 bar) @ 70°F (21°C), 100 PSIG (6.9 bar) @ 212°F (100°C) ²
Polypropylene Body	100 PSIG (6.9 bar) @ 70°F (21°C), 40 PSI (2.8 bar) Max. @ 180°F (82°C)
Operating Temperature	
Brass or Stainless Steel Body	-20°F to 212°F (-29°C to 100°C)
Polypropylene Body	-20°F to 180°F (-29°C to 82°C)
Electronics	150°F (65°C) Ambient
Viscosity, Maximum	200 SSU
Input Power	24 VDC, ±10%
Output Signal	0-10 VDC Analog Signal @ 1mA, Max.
Current Consumption	25 mA, Max.
Accuracy	
	See Table Below
Electrical Termination	
	22 AWG PVC-Jacketed, 24" Cable. Color Coded: Red = +VDC; Black = Ground; White = Signal Output

- Notes:
 1. Standard on Stainless Steel bodies.
 2. For higher pressure/temperature ratings stainless steel face plates are available. Consult factory.

How To Order

For standard configurations, specify Part Number based on desired body material and port size.

Body Material	Port Size NPT	Flow Ranges – GPM			
		Low Range (Accuracy)	Part Number	Standard Range (Accuracy)	Part Number
Polypropylene	.25"	0.1 to 1.0 (±7.0%)	230206 ⚡	0.5 to 5.0 (±7.0%)	230205 ⚡
	.50"	1.5 to 12.0 (±7.0%)	230207 ⚡	4.0 to 20.0 (±15.0%)	230201 ⚡
Brass	.25"	0.1 to 1.0 (±7.0%)	230209 ⚡	0.5 to 5.0 (±7.0%)	230202
	.50"	1.5 to 12.0 (±7.0%)	230210	4.0 to 20.0 (±15.0%)	230203
	.75"	—	—	5.0 to 30.0 (±10.0%)	230212
	1.00"	—	—	8.0 to 60.0 (±15.0%)	230214
Stainless Steel	9/16"-18	0.1 to 1.0 (±7.0%)	230211	0.5 to 5.0 (±7.0%)	230204
	.50"	1.5 to 12.0 (±7.0%)	230216	4.0 to 20.0 (±15.0%)	230208
	.75"	—	—	5.0 to 30.0 (±10.0%)	230213
	1.00"	—	—	8.0 to 60.0 (±15.0%)	230215

⚡ – Stock Items.



Typical Applications

- Water Purification/Dispensing Systems
- Chemical Metering Equipment
- Lasers and Welders
- Water Injection Systems
- Semiconductor Processing Equipment
- Chillers and Heat Exchangers

Dimensions

Polypropylene Bodies

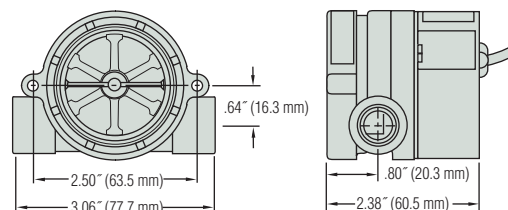

Brass and Stainless Steel Bodies - .25" and .50" Ports

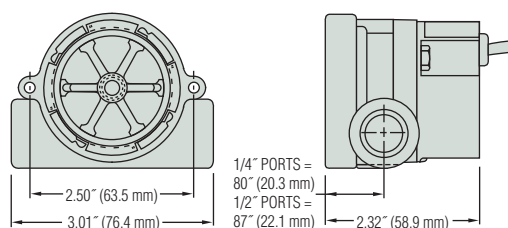

Brass Bodies – .75" and 1.00" NPT Ports

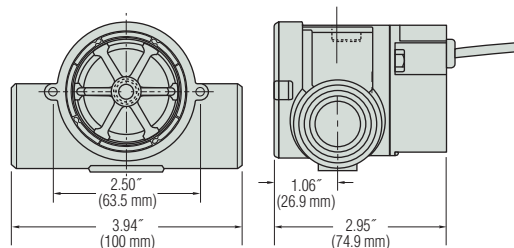

High Resolution Black Rotor

PPS composite. Each of the six rotor arms is magnetized. A PTFE loaded bushing ensures long life.



Visual Indicators – RFI Types

This is RotorFlow in its most basic form — a bright orange rotor turning with fluid flow. Simple, direct and reliable. Flow rate is estimated, or simply confirmed, by viewing the speed of the turning rotor. Either port may be used for incoming flow, and bayonet mounting lens is easily removed for quick cleanout. RFI Type RotorFlow sensors are easy to see, easy to install and easy to afford.

Typical Applications

- Visual flow confirmation on heat exchangers
- Plastic injection molding equipment

Specifications

Wetted Materials	
Body	Brass, 316 Stainless Steel or Polypropylene (Hydrolytically Stable, Glass Reinforced)
Rotor Pin	Ceramic
Rotor	High Visibility Orange, Molded Nylon
Lens	Polysulfone
O-Ring	Viton® (Brass Body); Buna N (Polypropylene Body)
Low Flow Adaptor	Glass Reinforced Polypropylene
Operating Pressure, Brass or Stainless Steel Body	
	100 PSIG (7 bar) @212°F (100°C) 200 PSIG (13.8 bar) Max. @ 70°F (21°C)
Polypropylene Body	
	100 PSIG (6.9 bar) at 70°F (21°C), 40 PSI (2.8 bar) Max. @ 180°F (82°C)
Operating Temperature, Brass or Stainless Steel Body	
	-20°F to 212°F (-29°C to 100°C)
Polypropylene Body	
	-20°F to 180°F (-29°C to 82°C)

Operating Principle

1. As liquid passes through the RotorFlow body, the rotor spins at a rate proportional to flow.
2. RotorFlow Indicators may be mounted with flow entering either port. At low flow rates, performance is optimized by positioning ports at the top of the unit, in a horizontal plane.

How To Order

Specify Part Number based on desired body material and port size.

Body Material	Port Size NPT	Flow Ranges – GPM		Part Number
		Low* Range	Standard Range	
Polypropylene	.25"	0.1 to 1.0	0.5 to 5.0	155420 ⚡
	.50"	1.5 to 12.0	4.0 to 20.0	155480 ⚡
Brass	.25"	0.1 to 1.0	0.5 to 5.0	142541 ⚡
	.50"	1.5 to 12.0	4.0 to 20.0	142542 ⚡
	.75"	—	5.0 to 30.0	180392 ⚡
	1.00"	—	8.0 to 60.0	181681 ⚡
Stainless Steel	9/16" - 18**	0.1 to 1.0	0.5 to 5.0	174596
	.50"	1.5 to 12.0	4.0 to 20.0	173138 ⚡
	.75"	—	5.0 to 30.0	181682
	1.00"	—	8.0 to 60.0	181683

* With use of Low Flow Adapter supplied. See Page F-8 for more information.

** Straight thread with O-ring seal.

⚡ – Stock Items.



Dimensions

Polypropylene Bodies

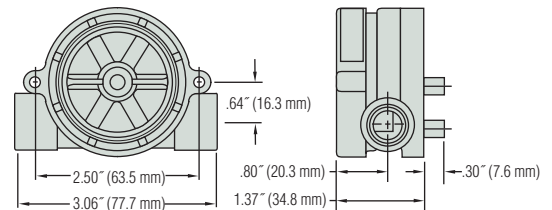

Brass and Stainless Steel Bodies - .25" and .50" Ports

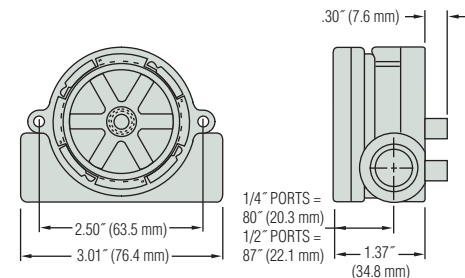

Brass Body – .75" and 1.00" Ports

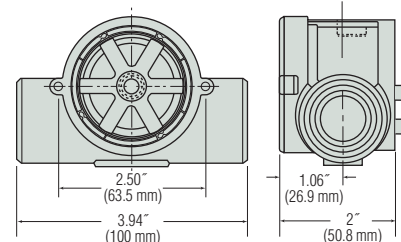

High Visibility Orange Rotor
Constructed of Molded Nylon for good general purpose compatibility with a wide range of fluids. Offers high visibility.



Easy Installation and Maintenance

A proper installation will enhance RotorFlow sensor performance. Install using standard pipe fitting tools; horizontal fluid lines are recommended. For further installation and maintenance recommendations, refer to one of the following instruction bulletins: RFO Types—Part Number 157258; RFI Types—Part Number 157259; RFS Types—Part Number 157261.

Since their function is to monitor dynamic fluid flow, naturally the rotor will react to turbulence, pulsation, entrained air, and other flow anomalies induced in the flow stream by other process hardware. For optimum performance, install RotorFlow units where nominal flow conditions exist with ports located at the top. Incoming flow may be placed to either port; a minimum of 8 inches (20 cm) of straight pipe on the inlet side is required. When operating in the low flow range, the supplied Low Flow Adapter must be installed in the incoming port.

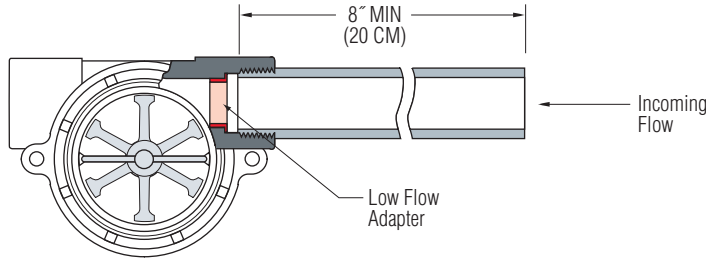

Except for straight-thread versions, RotorFlow sensors connect to piping via NPT mating thread forms. The use of an appropriate thread sealant is necessary to assure a leak-tight connection. Permatex "No More Leaks" or 2 wraps of Teflon tape are the only sealants recommended for GEMS flow sensors. Straight-thread versions require an O-ring for sealing.

150 micron filtration is recommended. However, should foreign particles enter the RotorFlow sensor, accumulation is easily cleared by removing the lens from the body. The lens is removed by turning its 7/16" hex center hub 45° counter-clockwise with a standard socket wrench. To reinstall the lens, simply reverse the process. Pressure must be relieved from the system prior to sensor clean-out. O-rings should be lubricated prior to re-assembly.

Low Flow Applications

A low flow adapter is supplied with all Rotorflow units. It is used to produce accurate response at low flow rates. Install the adapter, as shown above, in the port selected for incoming flow.

Panel Mounting

Plastic Bodies. Two (2) mounting ears are provided at the body center line to receive #8 self-tapping screws to accommodate panel mounting of the plastic RotorFlow units. Note: ANSI T type 23 self-tapping screws are recommended. They may be replaced with standard machine screws if re-installation should be required.

Brass and Stainless Steel Bodies. Two (2) mounting holes are provided on the body centerline, as shown below. #8-32UNC-2B screws are required for mounting.

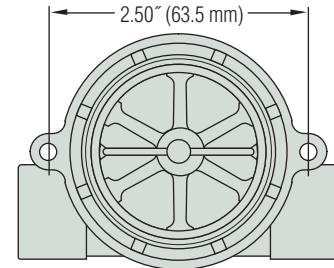

RotorFlow® Maintenance Kits

Rebuild your RotorFlow® Sensors and Switches in less than 5 minutes with one of these kits.

Includes:

- Ceramic Rotor Pin
- 6-Pole Magnetic Rotor with PPS/PTFE Bushing
- Buna N or Viton® O-Ring
- Polysulfone Lens

Rotorflow® Type		O-Ring Material in Kit	Part Numbers	
Line Size	Body Material		RFA/RFO/RFS	RFI
1/4" & 1/2"	Plastic	Buna-N	155870 ⚡	155872
	Brass/SS	Viton®	167364 ⚡	166267
3/4" & 1"	Brass/SS	Viton®	182695	157187

⚡ – Stock Items.

RotorFlow® Sensor Special Capabilities are Yours for the Asking.

Gems caters to OEM needs with special configurations that go beyond the standards in this catalog. We can provide RotorFlow sensors with enhanced chemical compatibility, higher temperature and pressure capabilities, and alternate electrical terminations.

Other Capabilities Available to OEMs:

- Electrical outputs: Combined switch and frequency; transistor switching; 0-10 VDC analog.
- Custom face plate (cast stainless steel face plate pictured)

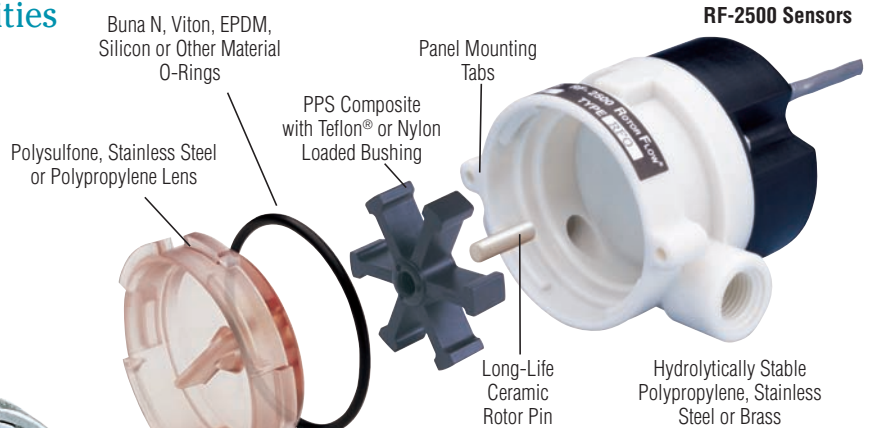

We are committed to providing our customers with the product that best meets the requirements of their applications. Please call us and tell us what you need, and ask us about Swagelok® tube fittings, faceplate options, and 9/16" and 3/4" straight-thread versions.

Call 800-378-1600

FT-110 Series – TurboFlow® Economical Flow-Rate Sensors

- ▶ Low Cost Plus High Accuracy ±3% of Reading
- ▶ Measures Low Liquid Flow Rates of .1 to 8 GPM
- ▶ Lightweight Plastic Design Enables Mounting in any Position

Gems Hall Effect turbine flow rate sensor is ideal for OEM applications involving low flow liquid monitoring. The low cost coupled with 1/2% repeatability makes it an ideal candidate for replacing dispensing timer systems. Unlike existing timing systems, turbine technology is not influenced by changes in system pressure caused by aging filters. The sensor's standard power and output specifications make it easy to retrofit to existing controllers.

Specifications

Wetted Materials	
Body	Nylon 12
Turbine	Nylon 12 Composite
Bearings	PTFE/15% Graphite
Operating Pressure	200 PSIG
Burst Pressure	2500 PSIG
Operating Temperature	-4°F to 212°F (-20°C to 100°C)
Viscosity	32 to 81 SSU (.8 to 16 Centistokes)
Filter	<50 Microns
Input Power	5 to 24 VDC @ 8mA
Output (Hz)	NPN Sinking Open Collector @ 20mA Maximum Leakage Current 10µA (Pull-Up Resistor Required)
Accuracy	±3% of Reading
Repeatability	0.5% of Full Scale
Electrical Connection	Spade Terminals .110" x .248" x .031" (2.8/6.3 x .8 mm) or 3 ft. cable
Inlet/Outlet Ports	3/8" NPT Male (3/8" G Male also available)

How To Order – Standard Models

Specify Part Number based on flow range.

For 1-meter (3-ft.) cable units, add "-C" to part number

Flow Range		Pulses per		Frequency Output	Part Number
GPM	Liters/m	Gallon	Liter		
.13-1.3	0.5-5	12500	3300	27-275 Hz	173932 ⚡
		26100	6900	58-575 Hz	173931 ⚡
.13-2.0	.5-7.5	17400	4600	38-575 Hz	173933 ⚡
.26-4.0	1-15	8300	2200	37-550 Hz	173934 ⚡
.53-7.9	2-30	3800	1000	33-500 Hz	173935 ⚡

⚡ – Stock Items.

FT-110 Accessories

Consult factory for special customized OEM versions.

Description	Part Number
Mating connector w/3 feet, 3 conductor, PVC pigtail cable	173941 ⚡
Mating connector w/10 feet, 3 conductor, PVC pigtail cable	173942 ⚡



Dimensions

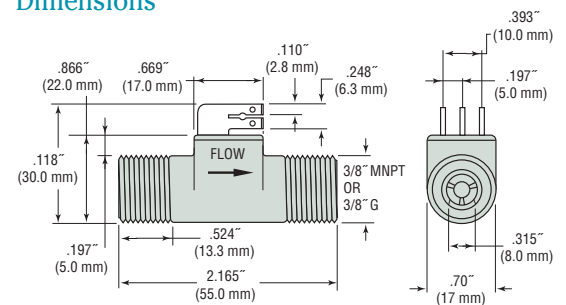

Wiring

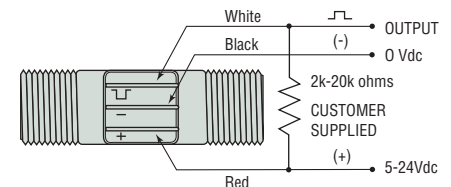

Cable Wire Code: Red = 5 to 24 VDC
Black = Ground
Brown = Signal Output

Pressure Drop—Typical

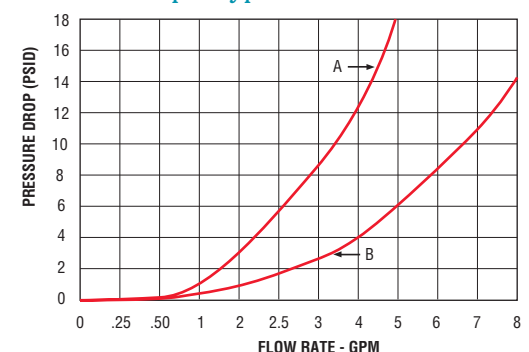

A) Part #173931
173932
173933

B) Part #173934
173935

FT-210 Series – TurboFlow® Low Flow Turbine Sensor

- ▶ Low Flow Rates .1 to 2.5 LPM and High Accuracy $\pm 3\%$ of Reading
- ▶ Lightweight Turbine Ensures Fast Startup
- ▶ Mounts In Any Orientation

Gems FT-210 features proven turbine technology in a small package for low flow applications. The turbine technology provides a highly repeatable sensor ideally suited for measurement of either volume dispensing and/or flow rate applications. The small turbine reacts quickly to on/off dispensing applications. Each sensor is 100% tested, ensuring years of service life.

Specifications

Wetted Materials	
Body	Nylon 12 (Grilamid TR55) or Grivory
Turbine	Nylon 12 Composite
Bearings	PTFE/15% Graphite
Operating Pressure	350 PSI (24 bar)
Burst Pressure	1400 PSI (97 bar)
Flow Range	.026- 65 gallons/minute 0.1-2.5 liters/minute 3.4-84.5 ounces/minute
Pulses	83,200 per gallon 22,000 per liter 650 per ounce
Frequency Output	36.6-917 Hz
Operating Temperature	-4°F to 212°F (-20°C to 100°C)
Viscosity	32 to 70 SSU (.8 to 16 Centistokes)
Filter	<50 Microns
Input Power	5 to 24 VDC
Output (Hz)	NPN Sinking Open Collector @ 20mA Maximum Leakage Current 10 μ A (3K-30K Pull up resistor required)
Accuracy	$\pm 3\%$ of Reading
Repeatability	0.5% of Full Scale
Electrical Connection	9.4mm Spacing 3-pole DIN Connector (1" high)
Inlet/Outlet Ports	1/4" NPT (1/4" G Male also available)



Dimensions

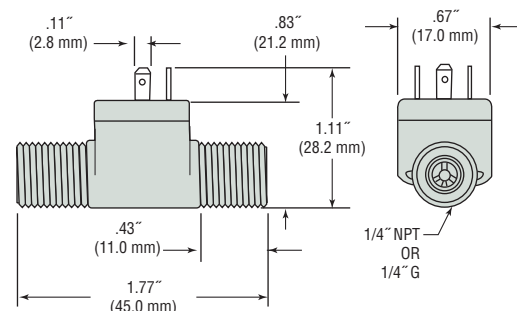

Wiring

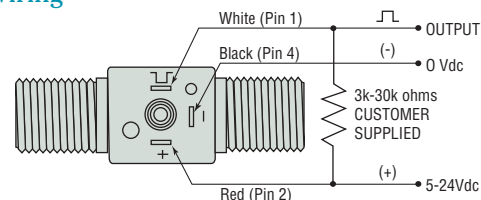

Pin Code: 1 = Output
2 = Supply
4 = Common

Pressure Drop—Typical

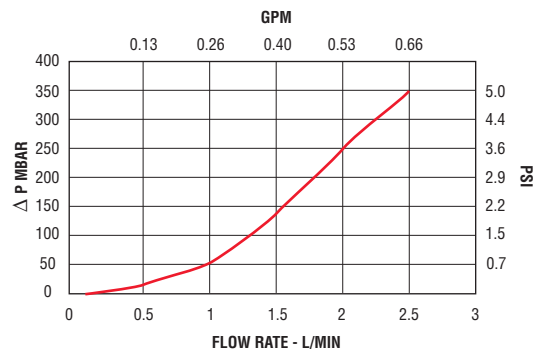

How To Order

Specify a Part Number for the Port Connection AND a Part Number for the DIN Electrical Connection. Two Part Numbers are required for a complete part assembly.

FT-210 Sensor

Body Material	Port Size	Part Number
Nylon 12	1/4" NPT	212465
	1/4" G	212460
Grivory®	1/4" NPT	223910
	1/4" G	223190

Electrical Connection

Description	Part Number
1 meter DIN PVC Cable Assembly with 10K pull-up resistor	218572
Mating DIN Connector	212404

FT-330 Series – NSF Approved Materials

- ▶ High Accuracy: $\pm 2\%$ of reading
- ▶ High repeatability: $\pm 0.5\%$ of reading
- ▶ Overmolded electronics with integral cable strain reinforcement
- ▶ Measures flow rates from .2 to 4 GPM
- ▶ Lightweight plastic design for multiple mounting positions

The FT-330 is a highly accurate and repeatable, Hall Effect turbine flow sensor designed for low flow OEM applications. This low cost, NSF Std. 61 listed flow sensor is ideal for water or beverage dispensing applications or any application with water based liquids. The 316SS shaft coupled with Delrin® bearings allows for accurate measurements during quick dispensing cycles. The sensor's standard power and output specifications make it easy to retrofit existing controllers.

Specifications

Materials	
Body	Glass Reinforced PPO (Noryl)
Turbine	PA Composite (Nylon)
Axle	316 Stainless Steel
Bearings	Delrin® (Polyoxymethylene, POM)
Inlet/Outlet Ports	3/8" NPT Male
Pressure	
Operating	200 PSIG
Burst	1000 PSIG
Operating Temperature	-4°F to 176°F (-20°C to 80°C)
Viscosity	32 to 81 SSU (1.8 to 16 Centistokes)
Recommended Filtration	< 50 Microns
Input Power	5 to 24 VDC @ 8mA
Output (Hz)	NPN Sinking Open Collector @ 25mA Maximum leakage current 10µA (5k to 30k Pull-Up Resistor Required)
Accuracy	$\pm 2\%$ of reading
Repeatability	$\pm 0.5\%$ of reading
Electrical Connection	3 ft PVC cable #22 AWG
Approvals	NSF Std. 61 listed

Wiring

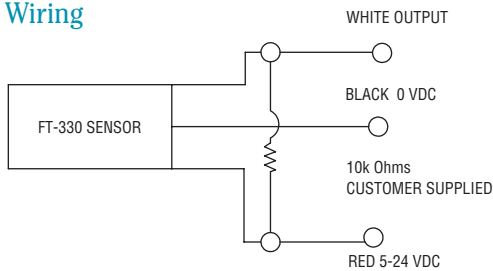

How To Order

Specify Part Number based on flow rate measuring capability.

Flow Range		Frequency Out	Pulses Per Gallon	Pulses Per Liter	Part Number
GPM	LPM				
0.2 to 2	0.8 to 7.6	34 to 343 Hz	10,313	2724	226000 ⚡
0.4 to 4	1.5 to 15	29 to 343 Hz	4,994	1319	226100 ⚡

⚡ – Stock Items.



NSF approved

Dimensions

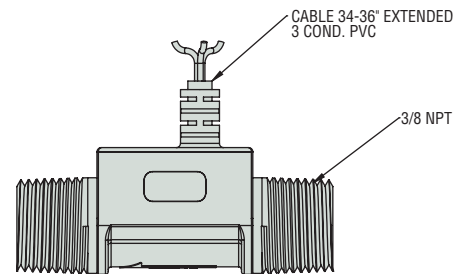
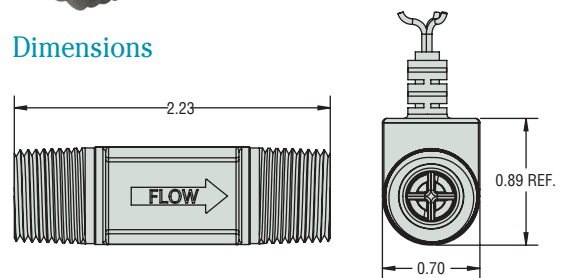

K-factor Chart* - Part Number 226000

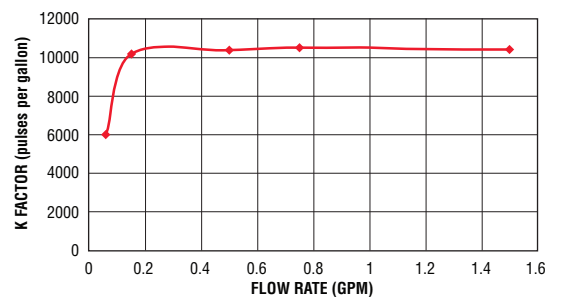

* Consult factory for P/N 226100 K-factor chart

Pressure Drop—Typical

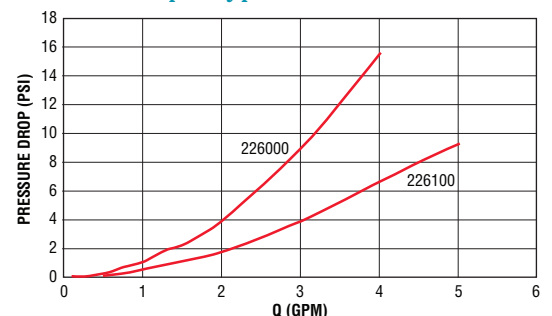

FS-600 Series – No Moving Part, Thermal Dispersion Flow Switch

Flow Rate Settings: 0.1 GPM to 11 GPM (0.5 LPM to 41 LPM)

Port Size: 1/2" to 1-1/2" (NPT or G thread)

Setting Type: Fixed

The FS-600 series uses proven thermal dispersion technology to provide a robust no moving part flow switch even without filtration. The solid state sensor is compatible with both conductive and non-conductive fluids. Suitable for fluids with particulates or slurries, and is immune to changes in media viscosity. The straight through switch is designed for a long life and can be mounted in any orientation and can handle a wide range of flow rates. No moving parts means years of reliable service.

Specifications

Wetted Materials	
Probe	303 Stainless Steel
Flow Body	316 Stainless Steel
Operating Pressure (Max.)	363 PSIG (25 bar)
Operating Temperature	-14° F to 140°F (-10°C to 60°C)
Power on Delay Time	15 Seconds Max (Output On)
Response Time	10 Seconds Max.
Inlet/Outlet Ports	1/2", 3/4", 1", 1-1/2" NPT 1/2", 3/4", 1", 1-1/2" G Internal
Operating Voltage	24 Vdc or 24Vac +/- 15%
Current Consumption	Less than 50mA
Switch Contact Rating	30Vac@45mA, 42Vdc @65mA
Switch Logic	Normally Open
Ingress Protection	IP65
Set point Accuracy	15%
Set point Differential	20% (Max.)
Electrical Termination	M12 x 1 (4-Pin) (1 meter cable included)
Approvals	CE

Calorimetric Principle/Thermal Dispersion

The operating principle of the FS-600 flow switch is based on the calorimetric principle. The FS-600 uses the cooling effect of a flowing fluid or gas to monitor the flow rate. The amount of thermal energy that is removed from the tip determines the local flow rate. This temperature-based operating principle can reliably sense the flow of virtually any liquid or gas.

The sensor tip of the FS-600 flow sensor houses two transistors and a heater element. One transistor is located in the sensor tip, closest to the flowing fluid. This transistor is used to detect changes in the flow velocity of the liquid. The second transistor is bonded to the cylindrical wall and is a reference for ambient fluid conditions.

In order to make the sensor sense flow, it is necessary to heat one of the transistors in the probe. When power is applied, the tip of the probe is heated. As the fluid starts to flow, heat will be carried away from the sensor tip. Cooling of the first transistor is a function of how fast heat is conducted away by the flowing liquid. The difference in temperature between the two transistors provides a measurement of fluid velocity past the sensor probe. When fluid velocity is high, the temperature differential is small. As fluid velocity decreases, there is an increase in temperature differential.

CE



Dimensions

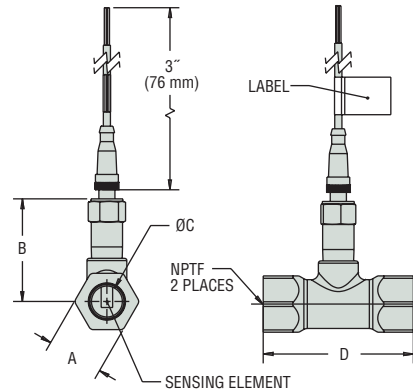

Port Size NPTF	A	B	C	D
1/2"	1.13 (28.7)	2.65 (67.3)	0.62 (15.8)	3.06 (77.8)
3/4"	1.50 (38.1)	2.75 (69.9)	0.824 (20.9)	4.00 (101.6)
1"	1.50 (38.1)	2.75 (69.9)	1.05 (26.7)	4.00 (101.6)
1-1/2"	2.25 (57.1)	3.00 (76.2)	1.61 (40.9)	4.25 (107.9)

Notes:

- Standard calibration is in water with units in a horizontal position.
- Consult Gems for special applications.

Wiring Diagram

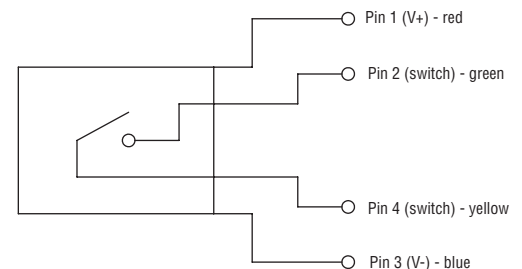

How To Order – Standard Models

Specify Part Number based on flow rates for the FS-600 Series per the following chart.

Port Size NPT	Flow Setting		Part Numbers	Port Size NPT	Flow Setting		Part Numbers
	GPM	LPM			GPM	LPM	
1/2"	0.13	0.48	230500-1-5	1"	0.64	2.20	230500-3-5
	0.24	0.90	230500-1-10		0.97	3.20	230500-3-10
	0.35	1.31	230500-1-15		1.31	4.25	230500-3-15
	0.46	1.73	230500-1-20		1.65	5.30	230500-3-20
	0.57	2.14	230500-1-25		1.99	6.5	230500-3-25
	0.68	2.56	230500-1-30		2.32	7.5	230500-3-30
	0.79	2.98	230500-1-35		2.66	8.5	230500-3-35
	0.90	3.39	230500-1-40		3.00	9.5	230500-3-40
	1.01	3.81	230500-1-45		3.33	10.0	230500-3-45
	1.12	4.23	230500-1-50		3.67	12.0	230500-3-50
	1.23	4.64	230500-1-55		4.01	13.0	230500-3-55
	1.34	5.06	230500-1-60		4.34	14.0	230500-3-60
	3/4"	0.35	1.31		230500-2-5	1-1/2"	1.48
0.57		2.15	230500-2-10	2.28	8.5		230500-4-10
0.79		2.99	230500-2-15	3.07	11.6		230500-4-15
1.01		3.83	230500-2-20	3.86	14.6		230500-4-20
1.23		4.67	230500-2-25	4.66	17.6		230500-4-25
1.46		5.51	230500-2-30	5.45	20.6		230500-4-30
1.68		6.00	230500-2-35	6.0	22.7		230500-4-35
1.90		7.00	230500-2-40	7.0	26.5		230500-4-40
2.12		8.00	230500-2-45	8.0	30.3		230500-4-45
2.34		9.00	230500-2-50	9.0	34.1		230500-4-50
2.57	10.00	230500-2-55	10.0	37.9	230500-4-55		
2.79	11.00	230500-2-60	11.0	41.6	230500-4-60		

Notes:
 1. G threads are available upon request. Minimum order quantities apply. Contact factory.
 2. -5 through -60 = fluid velocity (cm/s)

Accessories

Description	Part#
M12 cord Set-1 meter (Red 1, Green 2, Blue 3, Yellow 4) 22 AWG	557703-01M0
M12 cord Set-3 meter (Red 1, Green 2, Blue 3, Yellow 4) 22 AWG	557703-03M0
M12 cord Set-4 meter (Red 1, Green 2, Blue 3, Yellow 4) 22 AWG	557703-04M0
M12 cord Set-5 meter (Red 1, Green 2, Blue 3, Yellow 4) 22 AWG	557703-05M0

Fluid Velocity vs. Flow Rate in GPM/LPM

1/2" NPT Ports (1/2" G Port)

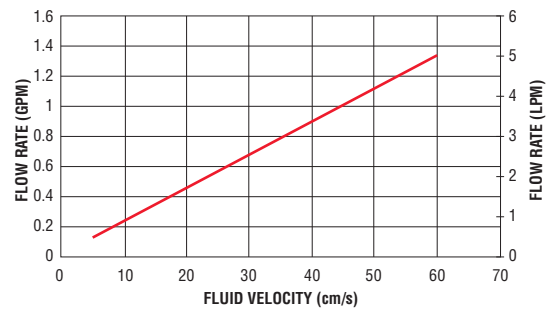

3/4" NPT and 1" NPT Ports (3/4" and 1" G Ports)

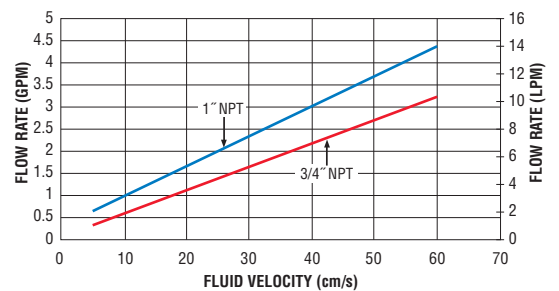

1-1/2" NPT Ports (1-1/2" G Ports)

