

MCDV 1,5/ 4-G-3,81

Order No.: 1830428

The figure shows a 10-position version of the product

<http://eshop.phoenixcontact.net/phoenix/treeViewClick.do?UID=1830428>

Header, Nominal current: 8 A, Rated voltage (III/2): 160 V, Number of positions: 4, Pitch: 3.81 mm, Color: green, Contact surface: Tin, Assembly: Soldering, In combination with MCV plug components, both an MCVW and an MCVR plug must be used.

Commercial data

EAN	 4 017918 110482
Pack	50 pcs.
Customs tariff	85366990
Gross weight in pieces	0.00376 KG
Net weight per piece (exclusive packing)	0.00331 KG
Catalog page information	Page 222 (CC-2011)

Product notes

WEEE/RoHS-compliant since:
01/01/2003

<http://www.download.phoenixcontact.com>
Please note that the data given here has been taken from the online catalog. For comprehensive information and data, please refer to the user documentation. The General Terms and Conditions of Use apply to Internet downloads.

Technical data

Dimensions / positions

Length	22.7 mm
Pitch	3.81 mm
Dimension a	11.43 mm

Number of positions	4
Pin dimensions	0,8 x 0,8 mm
Hole diameter	1.2 mm

Technical data

Range of articles	MCDV 1,5/..-G
Insulating material group	I
Rated surge voltage (III/3)	2.5 kV
Rated surge voltage (III/2)	2.5 kV
Rated surge voltage (II/2)	2.5 kV
Rated voltage (III/2)	160 V
Rated voltage (II/2)	250 V
Connection in acc. with standard	EN-VDE
Nominal current I_N	8 A
Nominal voltage U_N	160 V
Maximum load current	8 A
Insulating material	PA
Inflammability class according to UL 94	V0
Color	green
Nominal voltage, UL/CUL Use Group B	300 V
Nominal current, UL/CUL Use Group B	8 A
Nominal voltage, UL/CUL Use Group D	300 V
Nominal current, UL/CUL Use Group D	8 A

Certificates / Approvals



Certification

CSA, cULus Recognized, GOST, VDE Gutachten mit
Fertigungsüberwachung, IECCEB CB Scheme

Certifications applied for:

Certification Ex:

Diagrams/Drawings

Drilling plan/solder pad geometry

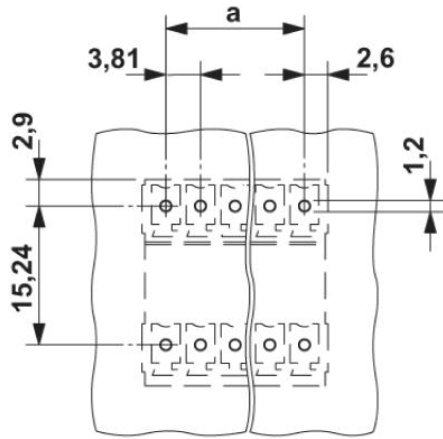

Dimensioned drawing

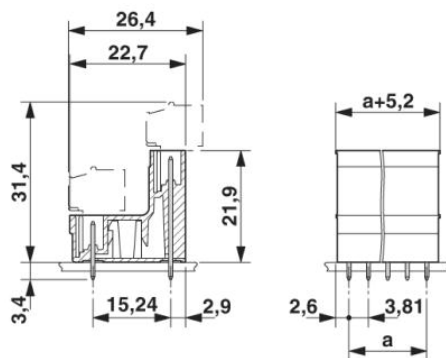

Address

PHOENIX CONTACT Ltd
Halesfield 13
Telford Shropshire TF7 4PG,GB
Phone 01952 681 700
Fax 01952 681 799
<http://www.phoenixcontact.co.uk>



© 2012 Phoenix Contact
Technical modifications reserved;