



Ceramic transient voltage suppressors

SMD multilayer varistor, E series

Series/Type:	CT1812S14BAUTOG
Ordering code:	B72580E1140S262
Date:	2012-11-07
Version:	1

Description

The E series multilayer ceramic varistors has been developed to protect automotive electronic circuits against transient overvoltages, such as electrostatic discharges and surge currents.

Features

- Reliable ESD protection up to 30 kV acc. to IEC 61000-4-2
- High energy absorption capability
- Low leakage current
- No temperature derating up to 150 °C
- High life time robustness
- Stable protection level
- RoHS-compatible, lead-free
- Qualified based on AEC-Q200
- PSpice simulation models available

Designation system

- CT **C**hip with **t**hree-layer-termination (Ag/Ni/Sn)
1812 Dimensions of the device **18** x **12** (length x width in 1/100 inch)
S...B **S**pecial tolerance **B** of the varistor voltage
14 Maximum RMS operating voltage
AUTO Suited for **AUTO**motive application
G Taped version, cardboard tape, 7" reel (1500 pcs./ reel)

Electrical data

Maximum operating voltage

RMS voltage

$$V_{\text{RMS}} = 14 \text{ V}$$

DC voltage

$$V_{\text{DC}} = 16 \text{ V}$$

Varistor voltage (@ 1 mA, 25 °C)

$$V_V = 22.0 \dots 27.0 \text{ V}$$

Maximum clamping voltage (@ 5 A)

$$V_{\text{clamp,max}} = 40 \text{ V}$$

Maximum leakage current (@ 16 V, 25 °C)

$$I_{\text{leak,max}} = 10 \mu\text{A}$$

Typical leakage current (@ 14 V, 25 °C)

$$I_{\text{leak}} = 3 \mu\text{A}$$

Maximum average power dissipation

$$P_{\text{diss,max}} = 15 \text{ mW}$$

Maximum surge current (8/20 μs)

$$I_{\text{surge,max}} = 1 \times 800 \text{ A}$$

Maximum energy absorption (2 ms)

$$W_{\text{max}} = 2400 \text{ mJ}$$

Load dump

$$W_{\text{LD}} = 10 \times 6 \text{ J}$$

Jump-start

$$V_{\text{jump}} = 24.5 \text{ V, 5 min.}$$

Capacitance (@ 1 kHz, 1 V, 25 °C; typical)

$$C_{\text{typ}} = 5.6 \text{ nF}$$

Response time

$$< 0.5 \text{ ns}$$

Operating temperature

$$-55 \dots +150 \text{ }^\circ\text{C}$$

Storage temperature (mounted parts)

$$-55 \dots +150 \text{ }^\circ\text{C}$$

V/I characteristics

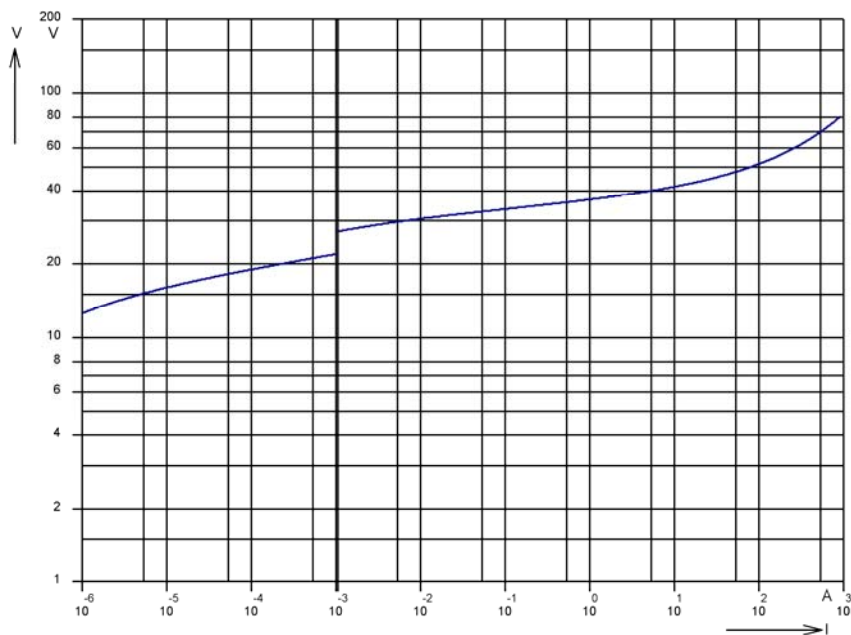

Derating curves

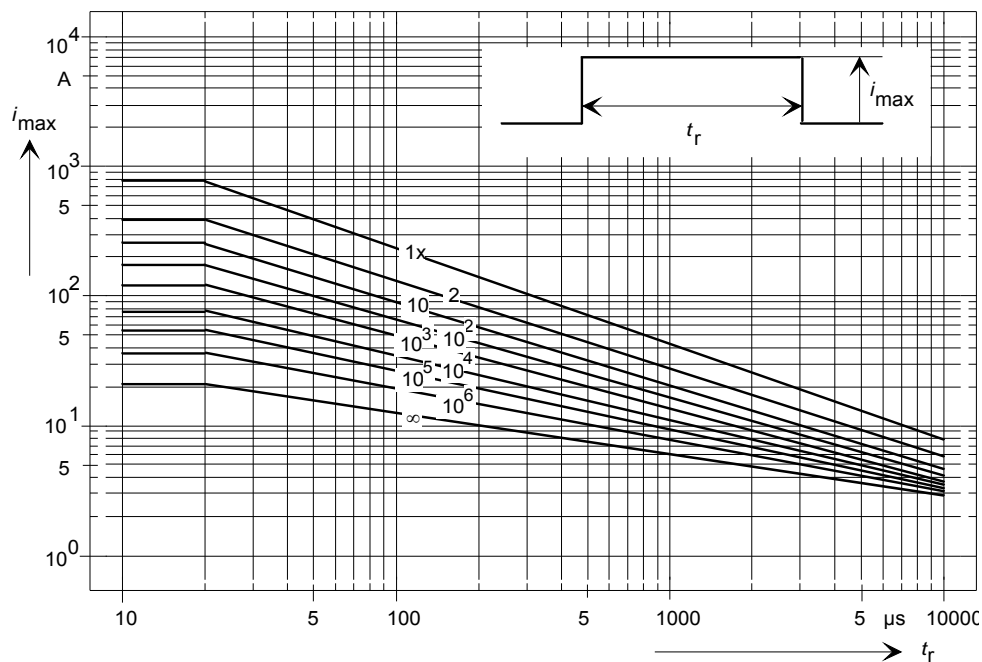

Temperature derating

The specified ratings for I_{max} , $I_{surge,max}$ and $P_{diss,max}$ are valid up to 150 °C. For operation above 150 °C we recommend the below derating.

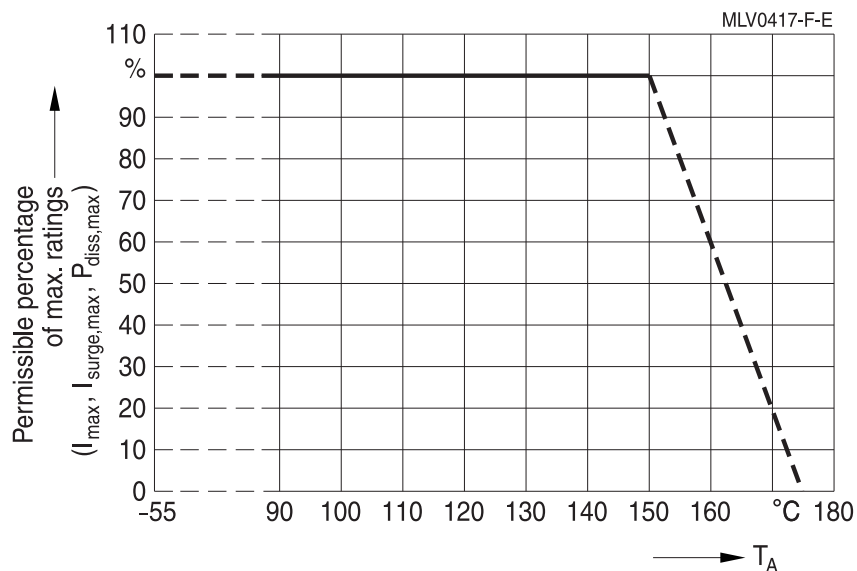

Dimensional drawing

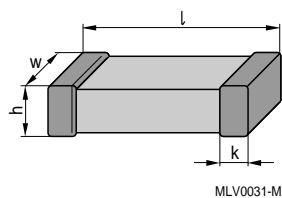

Dimensions in mm

Case size	l	w	h	k
1812	4.5 ±0.4	3.2 ±0.30	2.5 max	0.25 ... 1.00

Recommended solder pad layout

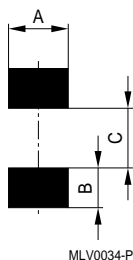

Dimensions in mm

Case size	A	B	C
1812	3.60	1.50	3.00

Recommended soldering profiles

Reflow soldering

Recommended temperature characteristic for reflow soldering following JEDEC J-STD-020D

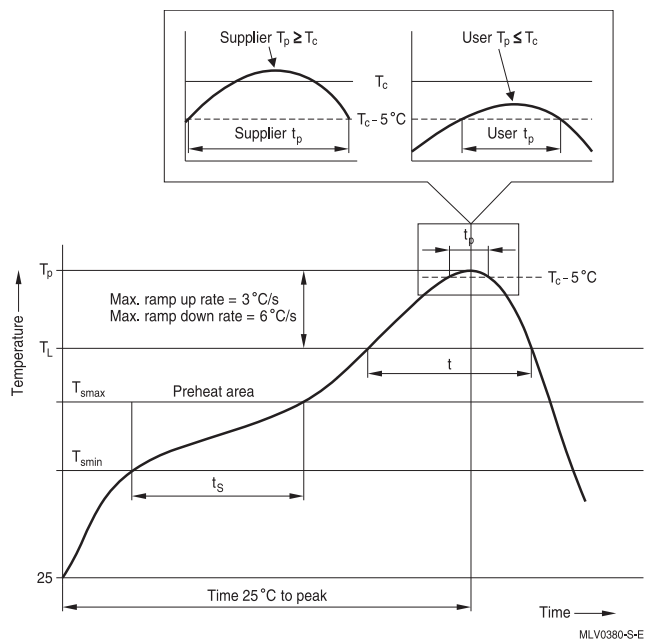

Profile feature		Sn-Pb eutectic assembly	Pb-free assembly
Preheat and soak			
- Temperature min	T_{smin}	100 °C	150 °C
- Temperature max	T_{smax}	150 °C	200 °C
- Time	t_{smin} to t_{smax}	60 ... 120 s	60 ... 180 s
Average ramp-up rate	T_{smax} to T_p	3 °C/s max.	3 °C/s max.
Liquidous temperature	T_L	183 °C	217 °C
Time at liquidous	t_L	60 ... 150 s	60 ... 150 s
Peak package body temperature	T_p ¹⁾	220 °C ... 235 °C ²⁾	245 °C ... 260 °C ²⁾
Time (t_p) ³⁾ within 5 °C of specified classification temperature (T_c)		20 s ³⁾	30 s ³⁾
Average ramp-down rate	T_p to T_{smax}	6 °C/s max.	6 °C/s max.
Time 25 °C to peak temperature		maximum 6 min	maximum 8 min

1) Tolerance for peak profile temperature (T_p) is defined as a supplier minimum and a user maximum.

2) Depending on package thickness. For details please refer to JEDEC J-STD-020D.

3) Tolerance for time at peak profile temperature (t_p) is defined as a supplier minimum and a user maximum.

Note: All temperatures refer to topside of the package, measured on the package body surface.

Number of reflow cycles: 3

Wave soldering temperature profile

Temperature characteristic at component terminal with dual-wave soldering

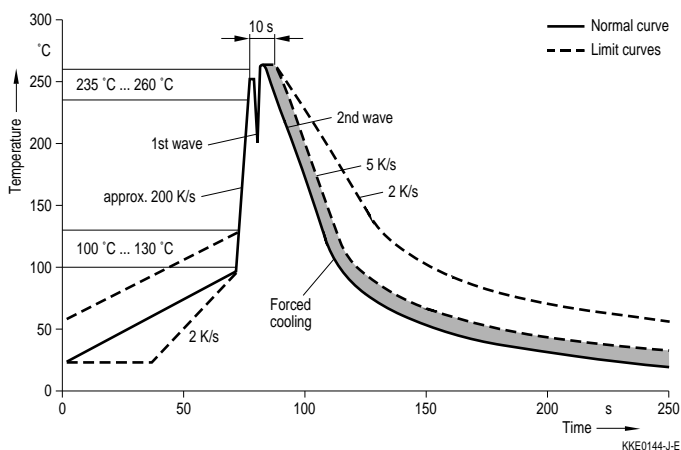

Soldering guidelines

The usage of mild, non-activated fluxes for soldering is recommended, as well as proper cleaning of the PCB.

Storage condition

- As far as possible, the components should be soldered within 12 months after delivery from EPCOS.
- Storage temperature: -25 up to +45 °C.
- Relative humidity: <75% annual average, <95% on max. 30 days in a year.

Taping and packaging

Tape and reel packing according to IEC 60286-3

Tape material: Blister

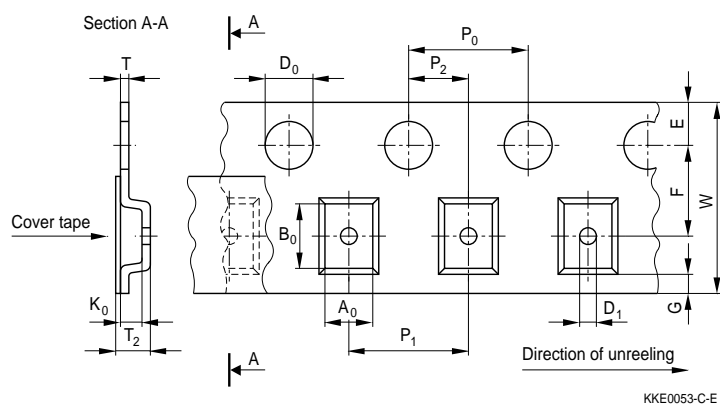

Dimensions and tolerances

Definition	Symbol	Dimension [mm]	Tolerance [mm]
Compartment width	A_0	3.5	± 0.2
Compartment length	B_0	4.8	± 0.2
Compartment height	K_0	1.3	max.
Sprocket hole diameter	D_0	1.5	$+0.1/-0$
Compartment hole diameter	D_1	1.5	min.
Sprocket hole pitch	P_0	4.0	± 0.1 ¹⁾
Distance center hole to center compartment	P_2	2.0	± 0.05
Pitch of the component compartments	P_1	8.0	± 0.1
Tape width	W	12.0	± 0.3
Distance edge to center of hole	E	1.75	± 0.1
Distance center hole to center compartment	F	5.5	± 0.05
Distance compartment to edge	G	0.75	min.
Overall thickness	T_2	2.5	max.
Thickness tape	T	0.3	max.

¹⁾ $\leq \pm 0.2$ mm over 10 sprocket holes.

Package: 8-mm tape

Packing

Packing material: Plastic

Reel dimensions

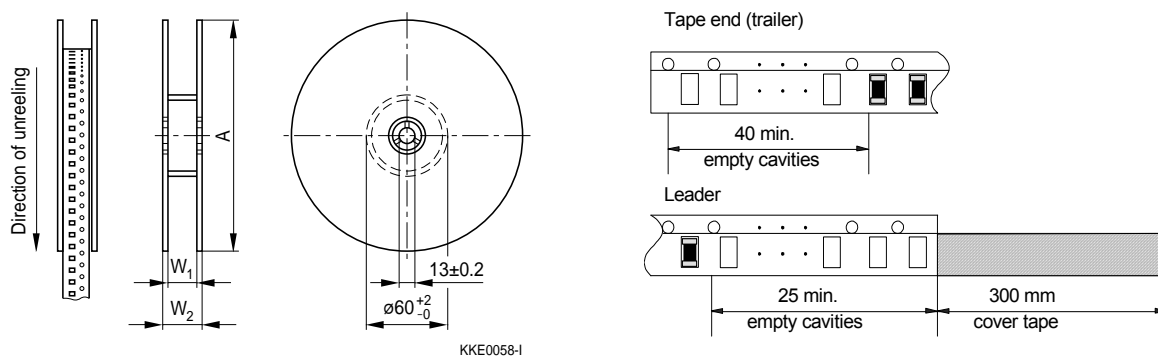

Dinition	Symbol	Dimension [mm]	Tolerance [mm]
Reel diameter	A	180	+0/-2
Reel width (inside)	W ₁	12.4	+1.5/-0
Reel width (outside)	W ₂	18.4	max.

Packing unit: 1500 pcs./ reel

Cautions and warnings

General

Some parts of this publication contain statements about the suitability of our ceramic transient voltage suppressor (CTVS) components (multilayer varistors (MLVs), CeraDiodes, ESD/EMI filters, SMD disk varistors (CU types), leaded transient voltage/ RFI suppressors (SHCV types)) for certain areas of application, including recommendations about incorporation/design-in of these products into customer applications. The statements are based on our knowledge of typical requirements often made of our CTVS devices in the particular areas. We nevertheless expressly point out that such statements cannot be regarded as binding statements about the suitability of our CTVS components for a particular customer application. As a rule, EPCOS is either unfamiliar with individual customer applications or less familiar with them than the customers themselves. For these reasons, it is always incumbent on the customer to check and decide whether the CTVS devices with the properties described in the product specification are suitable for use in a particular customer application.

- Do not use EPCOS CTVS components for purposes not identified in our specifications, application notes and data books.
- Ensure the suitability of a CTVS in particular by testing it for reliability during design-in. Always evaluate a CTVS component under worst-case conditions.
- Pay special attention to the reliability of CTVS devices intended for use in safety-critical applications (e.g. medical equipment, automotive, spacecraft, nuclear power plant).

Design notes

- Always connect a CTVS in parallel with the electronic circuit to be protected.
- Consider maximum rated power dissipation if a CTVS has insufficient time to cool down between a number of pulses occurring within a specified isolated time period. Ensure that electrical characteristics do not degrade.
- Consider derating at higher operating temperatures. Choose the highest voltage class compatible with derating at higher temperatures.
- Surge currents beyond specified values will puncture a CTVS. In extreme cases a CTVS will burst.
- If steep surge current edges are to be expected, make sure your design is as low-inductance as possible.
- In some cases the malfunctioning of passive electronic components or failure before the end of their service life cannot be completely ruled out in the current state of the art, even if they are operated as specified. In applications requiring a very high level of operational safety and especially when the malfunction or failure of a passive electronic component could endanger human life or health (e.g. in accident prevention, life-saving systems, or automotive battery line applications such as clamp 30), ensure by suitable design of the application or other measures (e.g. installation of protective circuitry or redundancy) that no injury or damage is sustained by third parties in the event of such a malfunction or failure. Only use CTVS components from the AUTO series in safety-relevant applications.

- Specified values only apply to CTVS components that have not been subject to prior electrical, mechanical or thermal damage. The use of CTVS devices in line-to-ground applications is therefore not advisable, and it is only allowed together with safety countermeasures like thermal fuses.

Storage

- Only store CTVS in their original packaging. Do not open the package before storage.
- Storage conditions in original packaging: temperature -25 to $+45^{\circ}\text{C}$, relative humidity $\leq 75\%$ annual average, maximum 95%, dew precipitation is inadmissible.
- Do not store CTVS devices where they are exposed to heat or direct sunlight. Otherwise the packaging material may be deformed or CTVS may stick together, causing problems during mounting.
- Avoid contamination of the CTVS surface during storage, handling and processing.
- Avoid storing CTVS devices in harmful environments where they are exposed to corrosive gases for example (SO_x , Cl).
- Use CTVS as soon as possible after opening factory seals such as polyvinyl-sealed packages.
- Solder CTVS components after shipment from EPCOS within the time specified:
 - CTVS with Ni barrier termination, 12 months
 - CTVS with AgPd termination, 6 months
 - SHCV and CU series, 24 months

Handling

- Do not drop CTVS components and allow them to be chipped.
- Do not touch CTVS with your bare hands - gloves are recommended.
- Avoid contamination of the CTVS surface during handling.

Mounting

- When CTVS devices are encapsulated with sealing material or overmolded with plastic material, be sure to observe the precautions in "Mounting instructions", "Sealing, potting and overmolding".
- Make sure an electrode is not scratched before, during or after the mounting process.
- Make sure contacts and housings used for assembly with CTVS components are clean before mounting.

- The surface temperature of an operating CTVS can be higher. Ensure that adjacent components are placed at a sufficient distance from a CTVS to allow proper cooling.
- Avoid contamination of the CTVS surface during processing.
- Multilayer varistors (MLVs) with AgPd termination are not approved for lead-free soldering.

Soldering

- Complete removal of flux is recommended to avoid surface contamination that can result in an instable and/or high leakage current.
- Use resin-type or non-activated flux.
- Bear in mind that insufficient preheating may cause ceramic cracks.
- Rapid cooling by dipping in solvent is not recommended, otherwise a component may crack.

Conductive adhesive gluing

- Only multilayer varistors (MLVs) with an AgPd termination are approved for conductive adhesive gluing.

Operation

- Use CTVS only within the specified operating temperature range.
- Use CTVS only within specified voltage and current ranges.
- Environmental conditions must not harm a CTVS. Only use them in normal atmospheric conditions. Reducing the atmosphere (e.g. hydrogen or nitrogen atmosphere) is prohibited.
- Prevent a CTVS from contacting liquids and solvents. Make sure that no water enters a CTVS (e.g. through plug terminals).
- Avoid dewing and condensation.
- EPCOS CTVS components are mainly designed for encased applications. Under all circumstances avoid exposure to:
 - direct sunlight
 - rain or condensation
 - steam, saline spray
 - corrosive gases
 - atmosphere with reduced oxygen content



Ceramic transient voltage suppressors

B72580E1140S262

SMD multilayer varistor, E series

CT1812S14BAUTOG

- EPCOS CTVS devices are not suitable for switching applications or voltage stabilization where static power dissipation is required.
- Multilayer varistors (MLVs) are designed for ESD protection and transient suppression. CeraDiodes are designed for ESD protection only, ESD/EMI filters are designed for ESD and EMI protection only.

This listing does not claim to be complete, but merely reflects the experience of EPCOS AG.

Important notes

The following applies to all products named in this publication:

1. Some parts of this publication contain **statements about the suitability of our products for certain areas of application**. These statements are based on our knowledge of typical requirements that are often placed on our products in the areas of application concerned. We nevertheless expressly point out **that such statements cannot be regarded as binding statements about the suitability of our products for a particular customer application**. As a rule, EPCOS is either unfamiliar with individual customer applications or less familiar with them than the customers themselves. For these reasons, it is always ultimately incumbent on the customer to check and decide whether an EPCOS product with the properties described in the product specification is suitable for use in a particular customer application.
2. We also point out that **in individual cases, a malfunction of electronic components or failure before the end of their usual service life cannot be completely ruled out in the current state of the art, even if they are operated as specified**. In customer applications requiring a very high level of operational safety and especially in customer applications in which the malfunction or failure of an electronic component could endanger human life or health (e.g. in accident prevention or life-saving systems), it must therefore be ensured by means of suitable design of the customer application or other action taken by the customer (e.g. installation of protective circuitry or redundancy) that no injury or damage is sustained by third parties in the event of malfunction or failure of an electronic component.
3. **The warnings, cautions and product-specific notes must be observed.**
4. In order to satisfy certain technical requirements, **some of the products described in this publication may contain substances subject to restrictions in certain jurisdictions (e.g. because they are classed as hazardous)**. Useful information on this will be found in our Material Data Sheets on the Internet (www.epcos.com/material). Should you have any more detailed questions, please contact our sales offices.
5. We constantly strive to improve our products. Consequently, **the products described in this publication may change from time to time**. The same is true of the corresponding product specifications. Please check therefore to what extent product descriptions and specifications contained in this publication are still applicable before or when you place an order.

We also **reserve the right to discontinue production and delivery of products**. Consequently, we cannot guarantee that all products named in this publication will always be available. The aforementioned does not apply in the case of individual agreements deviating from the foregoing for customer-specific products.
6. Unless otherwise agreed in individual contracts, **all orders are subject to the current version of the "General Terms of Delivery for Products and Services in the Electrical Industry" published by the German Electrical and Electronics Industry Association (ZVEI)**.
7. The trade names EPCOS, BAOKE, Alu-X, CeraDiode, CeraLink, CSMP, CSSP, CTVS, DeltaCap, DigiSiMic, DSSP, FilterCap, FormFit, MiniBlue, MiniCell, MKD, MKK, MLSC, MotorCap, PCC, PhaseCap, PhaseCube, PhaseMod, PhiCap, SIFERRIT, SIFI, SIKOREL, SilverCap, SIMDAD, SiMic, SIMID, SineFormer, SIOV, SIP5D, SIP5K, ThermoFuse, WindCap are **trademarks registered or pending** in Europe and in other countries. Further information will be found on the Internet at www.epcos.com/trademarks.