

Two-stage general-purpose filter

FN 660

- Current ratings from 1 to 20A
- High differential and common mode attenuation
- Four choices of output connector
- Optional medical versions (B type)

- Nennströme von 1 bis 20A
- Gute differentielle und Gleichtakt-Dämpfung
- Vier Anschlußarten
- Für medizinische Geräte als Option (Typ B)

- Courants de service de 1 à 20A
- Bonne atténuation en modes différentiel et commun
- Quatre types de connexions de sortie
- Version pour appareils médicaux en option (type B)



Filter selection table

Choose the family FN xxx with the required current rating and features, and add /?? to determine input/output (line/load) connection style. Example: FN 660-3/07 is a 3A filter with wire connections.

Approvals



Family	Connections				Current ratings at 40°C (25°) A	Inductance L/L1 mH	Housing	Weight g			
								/03	/06	/07	/10
FN 660 -1 /??		/06	/07		1 (1.15)	3/3	H21	115	125		
FN 660 -3 /??		/06	/07		3 (3.4)	2/2	K1	170	180		
FN 660 -6 /??		/06	/07		6 (6.9)	0.75/0.75	K1	170	180		
FN 660 -10 /??		/06	/07		10 (11.5)	0.45/0.45	K21	230	240		
FN 660 -16 /??	/03	/06		/10	16 (18.4)	0.44/0.44	K2	290	260		290
FN 660 -20 /??	/03	/06		/10	20 (23)	0.48/0.48	L1	600	590		640

Additional specifications

Filter type	Capacitance		Res. R MΩ	Maximum leakage μA/phase	Maximum operating voltage		Operating frequency Hz	Hipot test voltage	
	Cx nF	Cy nF			VAC	Hz		PN→E VAC	P→N VAC
Standard types	150	2.2	1	190	250	50/60	DC to 400	2000	1700
B types (medical)	150		1	2	250	50/60	DC to 400	2500	1700

MTBF at 40°C, 230V, per Mil-HB-217F: 350,000 hours (for VDE-approved current ratings).

Electrical schematic

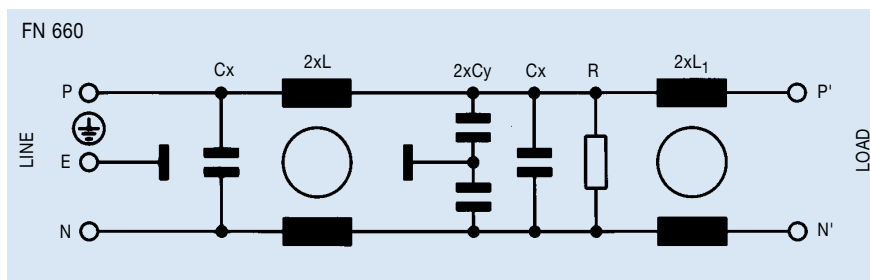

See tables for component values.

FN 660 insertion loss

Per CISPR 17; A = 50Ω/50Ω sym, B = 50Ω/50Ω asym, C = 0.1Ω/100Ω sym, D = 100Ω/0.1Ω sym

1 amp types

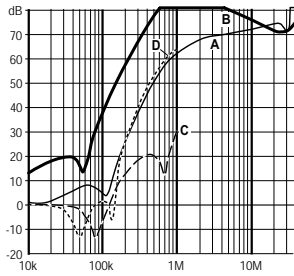

3 amp types

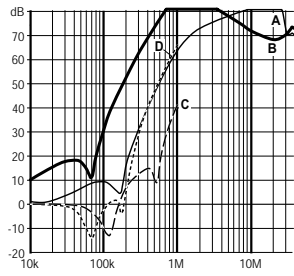

6 amp types

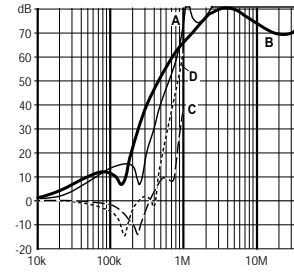

10 amp types

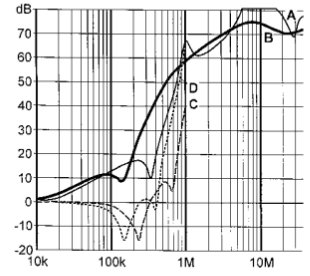

16 amp types

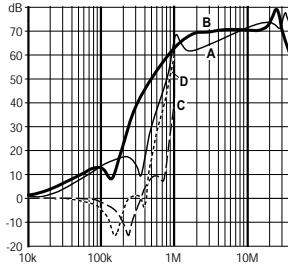

20 amp types

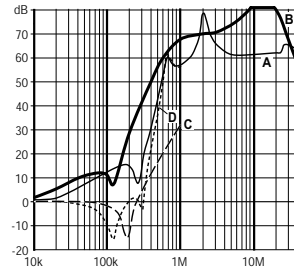

Mechanical data

	FN 660-1 H21	Tol. mm
A	71	± 0.5
B	46.6	± 1
C	29	± 1
D	50.5	± 1
F	61	± 0.2
J	21 ^(J1) 8.5 ^(J2)	± 0.5
K	10.5	± 0.3
L	19	± 0.5
M	5.3	± 0.1
N	6.3	± 0.1
Y	6	± 1
Z	140	+ 5

Front view

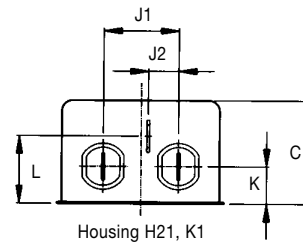
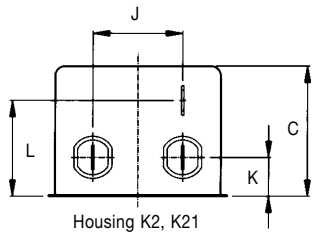

Top view

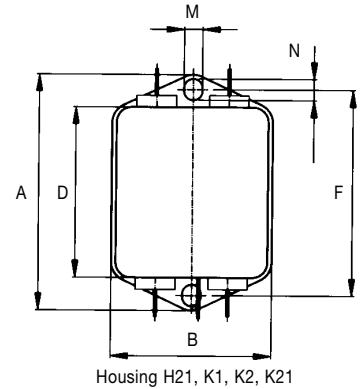

	FN 660 -3-6 K1	FN 660 -10/-16 K2, K21	FN 660 -20 L1	Tol.* mm
A		85	105	± 0.5
B		54	99.5 ± 1	± 0.5
C	30	40	38	± 1
D		65	84.5	± 1
E			79	± 0.5
F		75	95	± 0.2
G			51	± 0.1
J	27 ^(J1) 8.5 ^(J2)	27	40	± 0.5
K	7	12	9.5	± 0.5
L		29.5	19	± 0.5
M		5.3	4.4	± 0.1
N		6.3	6	± 0.1
W	AWG 16			-
Y		6		± 1
Z	300	140 + 5		+ 10

Front view

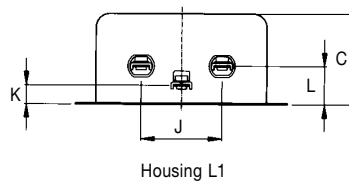

Top view

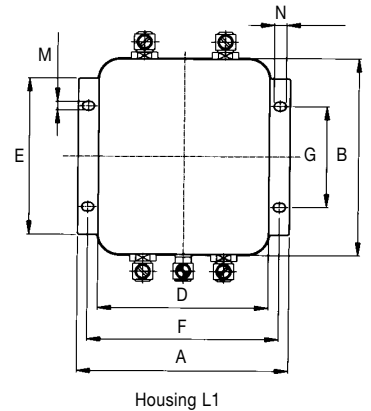

* Measurements share this common tolerance unless otherwise stated.

All dimensions in mm; 1 inch = 25.4 mm

Mouser Electronics

Authorized Distributor

Click to View Pricing, Inventory, Delivery & Lifecycle Information:

Schaffner:

[FN660-20-06](#) [FN660-6-06](#) [FN660-10-06](#) [FN660-3-06](#) [FN660-16-06](#) [FN660B-20-06](#) [FN660B-6-06](#) [FN660-1-06](#)
[FN660-20-10](#) [FN660-16-10](#) [FN660-16-03](#) [FN660-20-03](#) [FN660B-10-06](#) [FN660B-16-06](#)