

GRM31CR70J106KA01#

"#" indicates a package specification code.

Available   Complies with RoHS

< List of part numbers with package codes >
 GRM31CR70J106KA01L , GRM31CR70J106KA01K , GRM31CR70J106KA01B

Shape

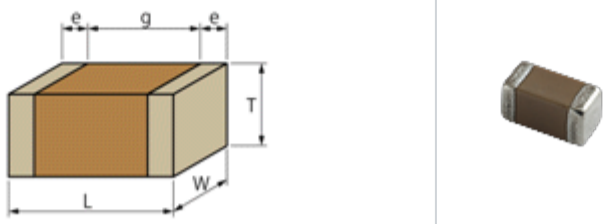
	
L size	3.2 ± 0.2mm
W size	1.6 ± 0.2mm
T size	1.6 ± 0.2mm
External terminal width e	0.3 to 0.8mm
Distance between external terminals g (Min.)	1.5mm
Size code in mm(inch)	3216 (1206)

References

Packaging	Specifications	Minimum quantity
L	Embossed tape (180mm)	2000
K	Embossed tape (330mm)	6000
B	Packing in bulk	1000

Mass (typ.)	
1 piece	52mg
Reel (180mm)	160g

Specifications

Capacitance	10µF ± 10%
Rated voltage	6.3Vdc
Temperature characteristics (complied standard)	X7R(EIA)
Capacitance change rate	± 15%
Temperature range of temperature characteristics	-55 to 125
Operating temperature range	-55 to 125

Attention

- 1.This datasheet is downloaded from the website of Murata Manufacturing Co., Ltd. Therefore, it ' s specifications are subject to change or our products in it may be discontinued without advance notice. Please check with our sales representatives or product engineers before ordering.
- 2.This datasheet has only typical specifications because there is no space for detailed specifications. Therefore, please review our product specifications or consult the approval sheet for product specifications before ordering.

▪ Frequency characteristics (ESR, Impedance)

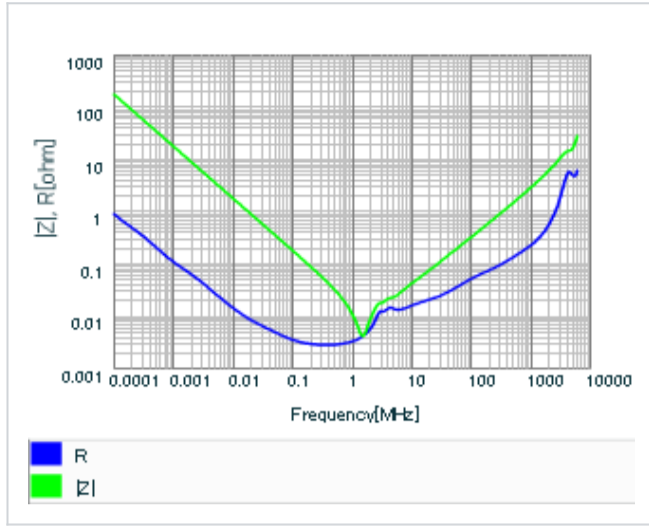

▪ S parameter (Smith chart S11)

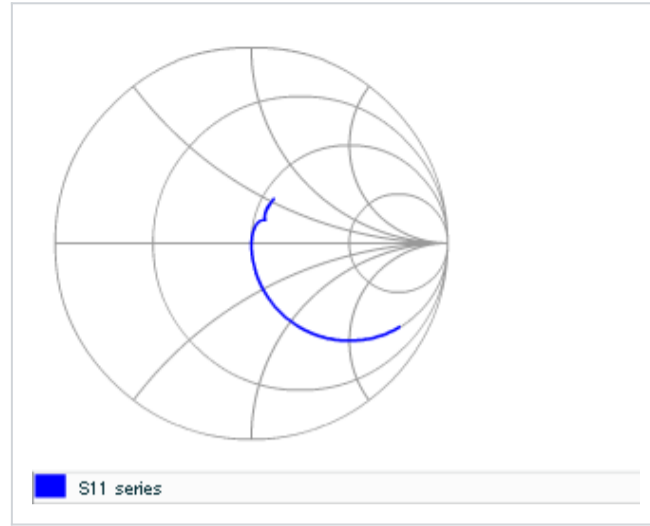

▪ DC bias characteristics

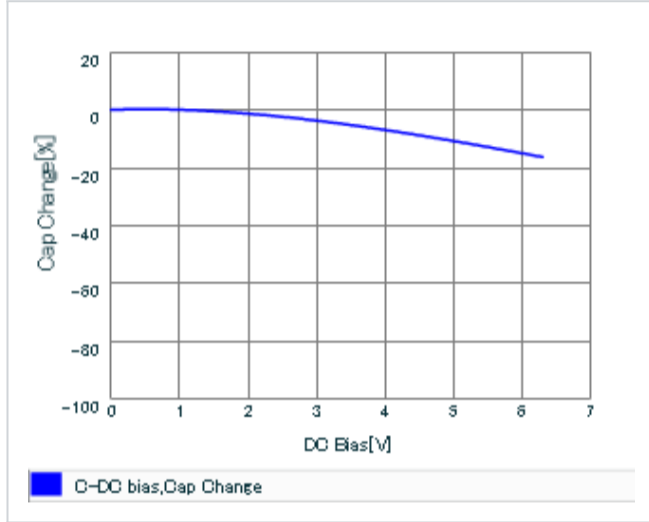

▪ AC voltage characteristics

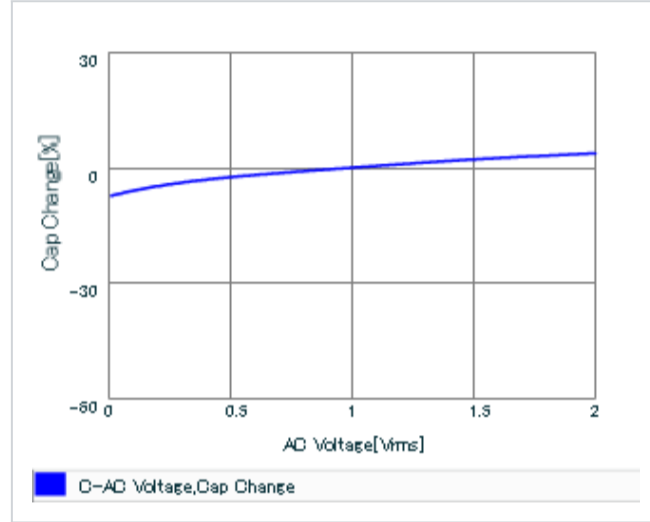

▪ Capacitance - temperature characteristics

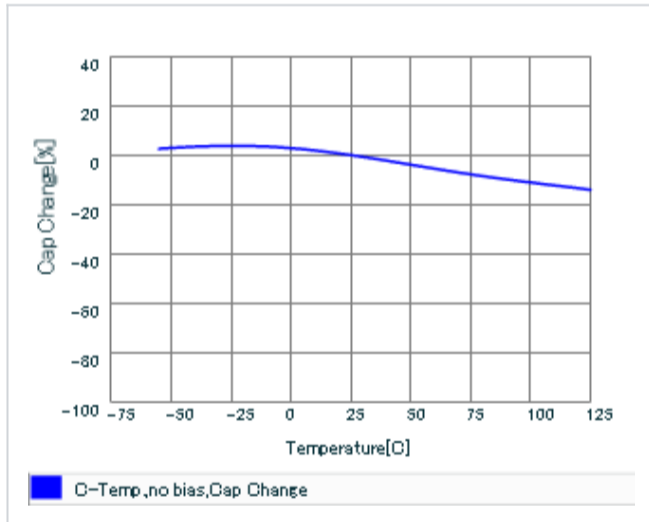

▪ Calorific property by ripple current

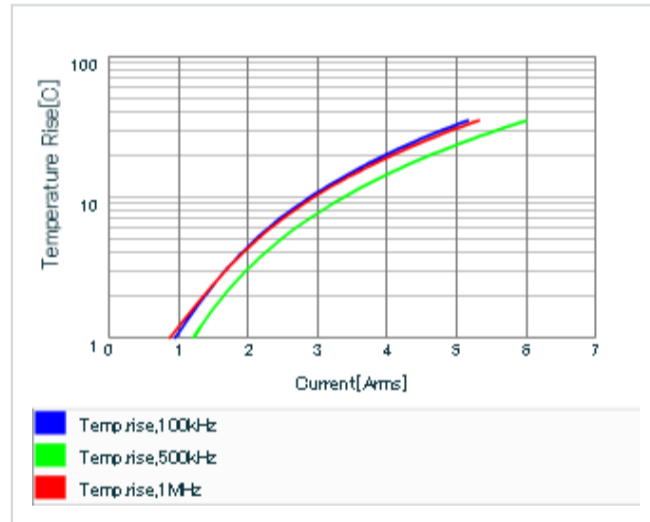

This PDF data has only typical specifications because there is no space for detailed specifications. Therefore, please review our product specifications or consult the approval sheet for product specifications before ordering.