

<b>Title</b>	<b><i>Reference Design Report for a 12 W Non-Isolated, Buck Topology, Power Factor Corrected, LED Driver Using LinkSwitch<sup>™</sup>-PH LNK405EG</i></b>
<b>Specification</b>	90 VAC – 265 VAC Input; 36 V, 330 mA Output
<b>Application</b>	LED Driver
<b>Author</b>	Applications Engineering Department
<b>Document Number</b>	RDR-257
<b>Date</b>	January 6, 2011
<b>Revision</b>	1.0

### **Summary and Features**

- Dramatically simplifies off-line, power factor corrected, LED driver design
  - Single-stage, power factor corrected, non-isolated LED driver
  - Compact with extremely low component count
  - High power factor >0.9 across line and load
  - Very high efficiency >85%, 87% typical
  - Low THD, <20% at 230 VAC
  - No output current sensing required
- Advanced performance features
  - Compensates for inductance tolerance
  - Compensates for input voltage variations
  - Compensates for output voltage variations
  - Frequency jittering greatly reduces EMI filter costs
- Advanced protection and safety features
  - Auto-restart protection for short-circuit
  - Hysteretic thermal shutdown

### **PATENT INFORMATION**

The products and applications illustrated herein (including transformer construction and circuits external to the products) may be covered by one or more U.S. and foreign patents, or potentially by pending U.S. and foreign patent applications assigned to Power Integrations. A complete list of Power Integrations' patents may be found at [www.powerint.com](http://www.powerint.com). Power Integrations grants its customers a license under certain patent rights as set forth at <http://www.powerint.com/ip.htm>.

## Table of Contents

1	Introduction.....	4
2	Power Supply Specification .....	7
3	Schematic.....	8
4	Circuit Description .....	9
5	PCB Layout .....	10
6	Bill of Materials .....	11
6.1	Electrical.....	11
6.2	Optional OVP Circuit .....	11
6.3	Mechanical .....	12
7	Heat Sink Assembly .....	13
8	Inductor Specification .....	14
8.1	Electrical Diagram .....	14
8.2	Electrical Specifications.....	14
8.3	Materials.....	14
8.4	Inductor Build Diagram.....	14
9	Performance Data .....	15
9.1	Efficiency.....	15
9.2	Line and Load Regulation.....	16
9.3	Power Factor .....	17
9.4	THD.....	18
9.5	Harmonics .....	19
9.6	Test Data.....	21
9.6.1	Test Data, 13 LED Load.....	21
9.6.2	Test Data, 12 LED Load.....	21
9.6.3	Test Data, 11 LED Load.....	21
9.6.4	230 VAC, 50 Hz Harmonics Data, $P_{IN} = 14.529$ W.....	22
9.6.5	115 VAC, 60 Hz Harmonics Data, $P_{IN} = 13.96$ W.....	23
10	Waveforms .....	24
10.1	Input Line Current.....	24
10.2	Drain Voltage and Current Normal Operation.....	25
10.3	Drain Voltage and Current Start-up Operation .....	26
10.4	Output Current, Normal Condition, $V_{OUT} \sim 36$ V .....	27
10.5	Output Current Ripple, $V_{OUT} \sim 36$ V.....	28
10.6	Output Current and Voltage at Power-up, Power-down .....	29
10.7	Output Short.....	30
10.8	Open Load/LED Condition.....	30
11	Thermal Measurements.....	31
11.1	Thermal Test Set-up.....	31
11.2	Thermal Test Results .....	31
12	Conducted EMI Measurements .....	32
12.1	Conducted EMI Test Set-up .....	32
12.1.1	Configuration A: Solder Side of Driver Facing Grounded T8 Fixture.....	32
12.1.2	Configuration B: Component Side of Driver Facing Grounded T8 Fixture..	33
12.2	Conducted EMI Test Results.....	34



12.3 Configuration A Conducted Emission ..... 34  
12.4 Configuration B Conducted Emission ..... 36  
13 Power Line Transient Tests ..... 38  
14 Revision History ..... 39

**Important Note:**

Although this board is designed to satisfy safety isolation requirements, the engineering prototype has not been agency approved. Therefore, all testing should be performed using an isolation transformer to provide the AC input to the prototype board.



## 1 Introduction

The document describes a non-isolated, power-factor corrected, low THD, high efficiency LED driver designed to drive an LED string with a nominal voltage of 36 V at a current of 330 mA from an input voltage range of 90 VAC to 265 VAC. It is designed to fit inside a T8 tube fixture.

The LinkSwitch-PH has been developed to cost effectively design a single-stage power factor corrected LED driver with primary-side constant current control. The LinkSwitch-PH controller was optimized for LED driver applications with minimal external parts count and control of the output current through the LED load without the use of an optocoupler.

The LinkSwitch-PH monolithically integrates the 725 V power MOSFET and controller. The controller consists of an oscillator, PWM, 6 V regulator, BYPASS pin programming functions, over-temperature protection, frequency jittering, cycle-by-cycle current limit, leading edge blanking, and charge controller for output CC (constant-current) control.

The LinkSwitch-PH also provides a sophisticated range of protection features including auto-restart for control loop open/short faults and output short-circuit conditions. Accurate hysteretic thermal shutdown ensures safe average PCB temperatures under all conditions.

The non-isolated power factor corrected buck presented in this report shows how LinkSwitch-PH dramatically simplifies off-line, high-efficiency, power factor corrected LED driver design with very low parts count.

This document contains the LED driver specification, schematic, PCB diagram, bill of materials, conducted EMI measurements, thermal measurements, power line transient tests, inductor documentation and typical performance characteristics.





Figure 1 – Populated Circuit Board Photograph.

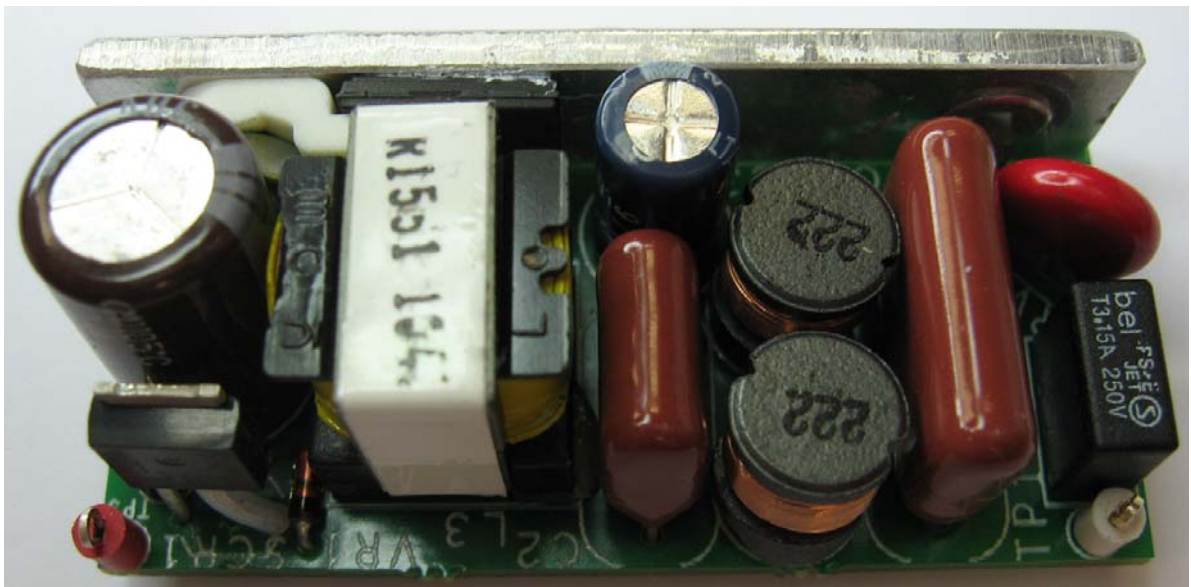


Figure 2 – Populated Circuit Board Photograph, Top.



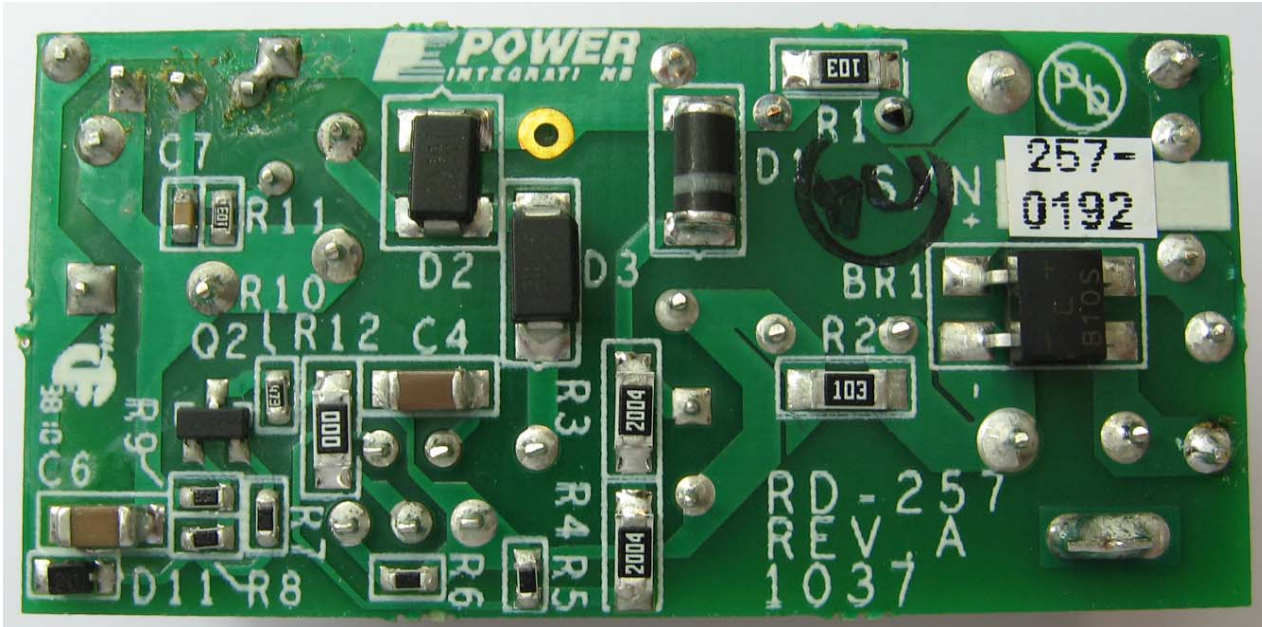


Figure 3 – Populated Circuit Board Photograph, Bottom.

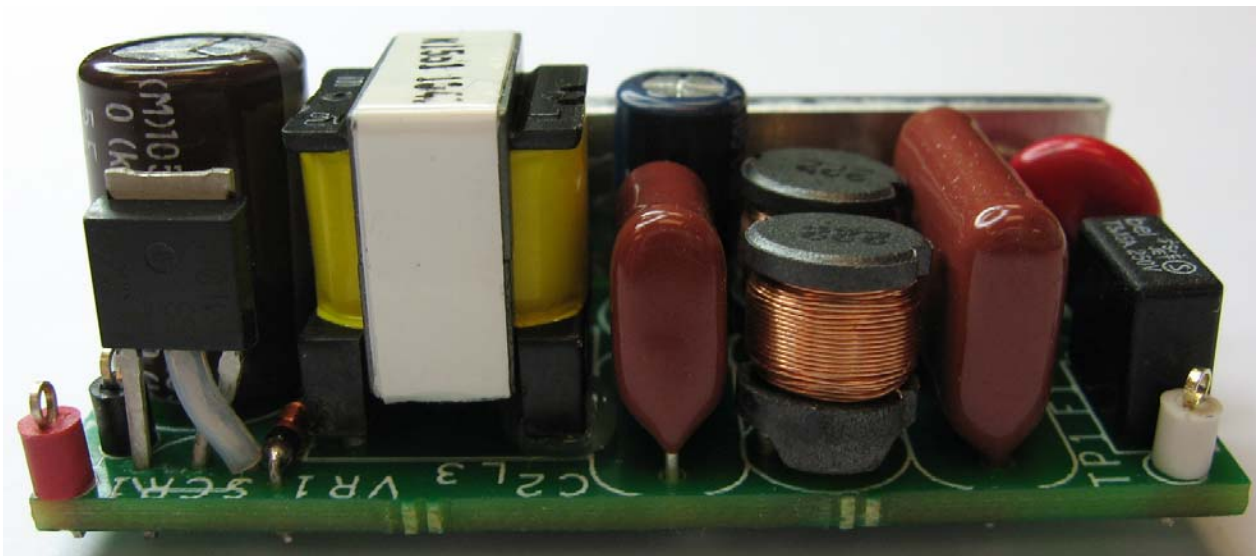


Figure 4 – Side View Showing SCR Rework.

**Note: The SCR on this board has been replaced with a higher current surge rating SCR for improved reliability during open load conditions. The original footprint on the board caters for a TO-92 package and the board will be revised to fit the TO-251 package on a future revision.**



## 2 Power Supply Specification

The table below represents the minimum acceptable performance of the design. Actual performance is listed in the results section.

Description	Symbol	Min	Typ	Max	Units	Comment
<b>Input</b>						
Voltage	$V_{IN}$	90		265	VAC	2 Wire – no P.E.
Frequency	$f_{LINE}$	47	50/60	63	Hz	
<b>Output</b>						
LED Voltage	$V_{OUT}$	30	36	38	V	
LED Current			330		mA	
<b>Total Output Power</b>						
Continuous Output Power	$P_{OUT}$		12		W	
<b>Environmental</b>						
Conducted EMI		Meets CISPR22B / EN55022B				
Safety		Non isolated				
Line Transient				2.5	kV	Ringwave (500 A)
Efficiency		85				
Harmonic		Class C				61000-3-2
Power Factor		0.9				
Ambient Temperature	$T_{AMB}$		25		°C	





### 3 Schematic

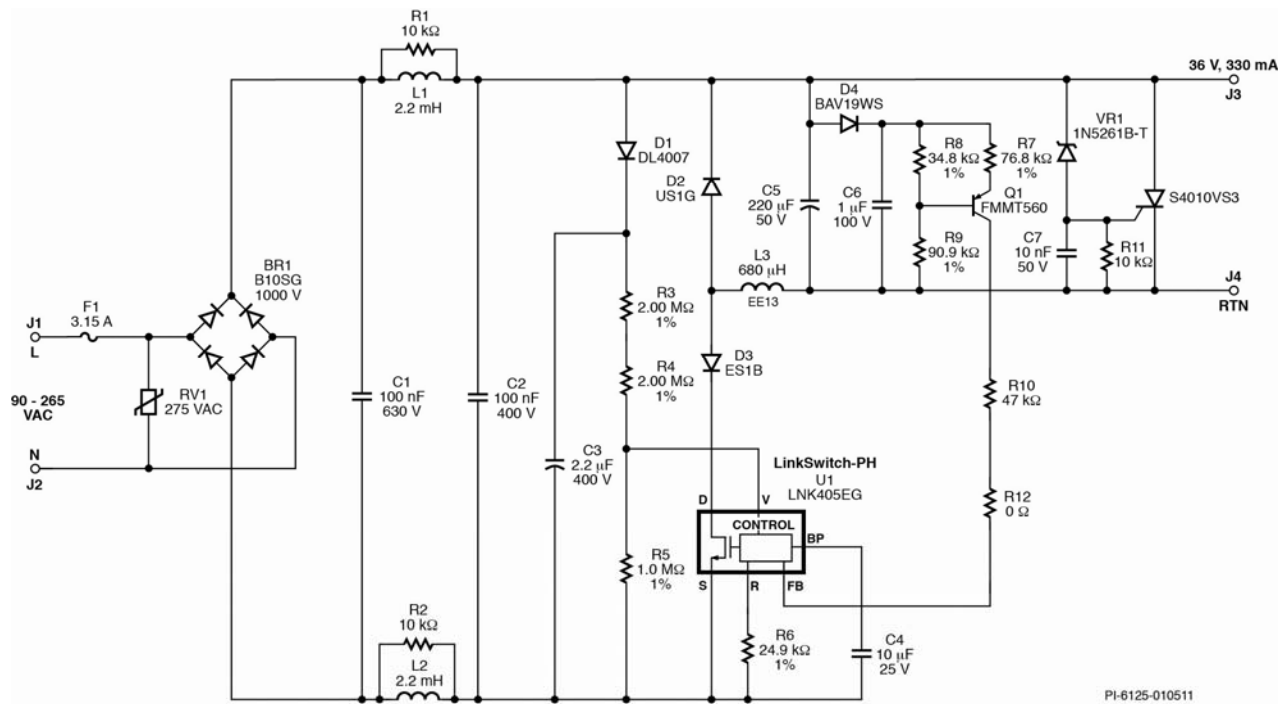


Figure 5 – Schematic.





## 4 Circuit Description

The LinkSwitch-PH (U1) is a highly integrated primary side controller intended for use in LED driver applications. The LinkSwitch-PH provides high power factor in a single-stage conversion topology while regulating the output current in a wide range of input and output voltage variations typical in LED driver application environment. All of the control circuitry responsible for these functions plus a high-voltage power MOSFET is incorporated into the device.

Capacitor C1, C2, and differential choke L1, and L2 perform EMI filtering while maintaining high-power factor. This input filter network plus the frequency jittering feature of LinkSwitch-PH allows compliance to Class B emission limits. Resistor R1 and R2 were used to damp the resonance of the EMI filter, preventing peaks in EMI.

The buck power circuit with floating output connection composed of U1 (power switch + control), D2 (free-wheeling diode), C5 (output capacitor), and L3 (output inductor). Diode D3 was used to prevent negative voltage appearing across drain-source of U1 especially near the zero-crossing of the input voltage. Diode D1 and C3 detect the peak AC line voltage. The voltage across C3 along with R3, R4, and R5 sets current fed into the V pin. This current is used by U1 to control line undervoltage (UV), overvoltage (OV), and provide feed-forward current which in conjunction with the FEEDBACK pin current provides constant current to the LED load.

The FEEDBACK pin current used by U1 for output voltage feedback is provided by the voltage to current converter network formed by R7-R10, Q1, C6, and D4. Output voltage is converted to feedback current by the following relation:

$$I_{FB} \approx k \times V_{OUT} \text{ where}$$

$$k = \frac{1}{R7} * \frac{R8}{R8 + R9}$$

The voltage across R8 was chosen to be high enough to eliminate or minimize the effect of the temperature and  $V_{CE}$  dependence on the  $V_{BE}$  voltage of Q1

The board also has an optional OVP circuit formed by VR1, SCR1, R11 and C7. During open load condition SCR1 will conduct and force U1 to enter into auto-restart condition.



### 5 PCB Layout

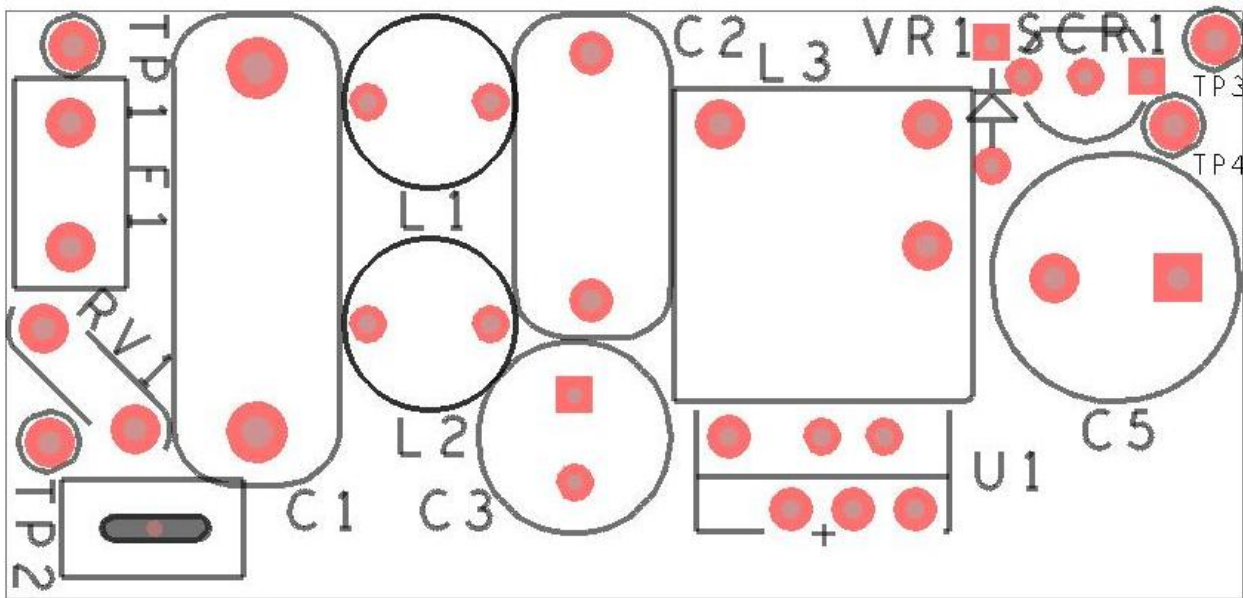


Figure 6 – Printed Circuit Layout,, Top, 2" (50.8 mm) x 0.95" (24.1 mm).

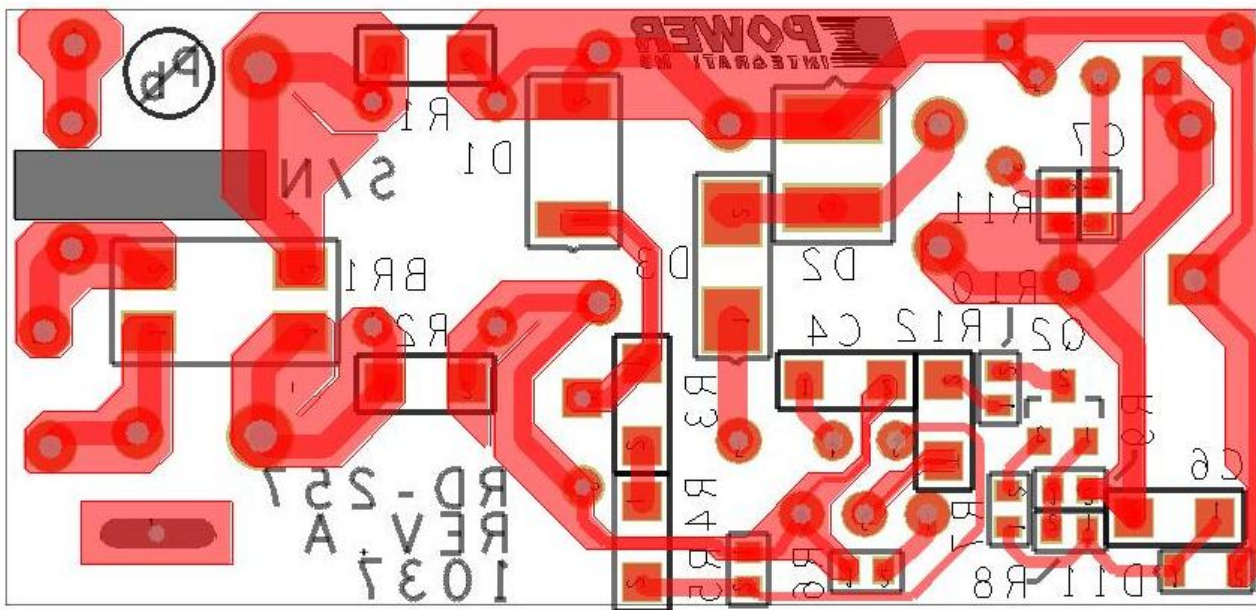


Figure 7 – Printed Circuit Layout,, Bottom.

## 6 Bill of Materials

### 6.1 Electrical

Item	Qty	Ref Des	Description	Mfg Part Number	Mfg
1	1	BR1	1000 V, 0.8 A, Bridge Rectifier, SMD, MBS-1, 4-SOIC	B10S-G	Comchip
2	1	C1	100 nF, 630 V, Film	ECQ-E6104KF	Panasonic
3	1	C2	100 nF, 400 V, Film	ECQ-E4104KF	Panasonic
4	1	C3	2.2 $\mu$ F, 400 V, Electrolytic, (6.3 x 11)	TAB2GM2R2E110	LTEC
5	1	C4	10 $\mu$ F, 25 V, Ceramic, X7R, 1206	ECJ-3YB1E106M	Panasonic
6	1	C5	220 $\mu$ F, 50 V, Electrolytic, Very Low ESR, 42 m $\Omega$ , (10 x 16)	EKZE500ELL221MJ16S	Nippon Chemi-Con
7	1	C6	1 $\mu$ F, 100 V, Ceramic, X7R, 1206	ECJ-3YB1E105K	Panasonic
8	1	D1	1000 V, 1 A, Rectifier, Glass Passivated, DO-213AA (MELF)	DL4007-13-F	Diodes Inc
9	1	D2	400 V, 1 A, Ultrafast Recovery, 35 ns, SMB Case	US1G	Diodes Inc
10	1	D3	100 V, 1 A, Ultrafast Recovery, 25 ns, DO-214AC	ES1B-13-F	Diodes Inc
11	1	D4	100 V, 0.2 A, Fast Switching, 50 ns, SOD-323	BAV19WS-7-F	Diode Inc.
12	1	F1	3.15 A, 250 V, Slow, RST	507-1181	Belfuse
13	2	L1 L2	2.2 mH, 0.19 A, Ferrite Core	CTCH895F-222K	CTParts
14	1	L3	EE13 680 $\mu$ H Inductor	SNX R1551	Santronics USA
15	1	Q1	PNP, Small Signal BJT, 500 V, 0.15 A, SOT23	FMMT560TA	Zetex
16	2	R1 R2	10 k $\Omega$ , 5%, 1/4 W, Thick Film, 1206	ERJ-8GEYJ103V	Panasonic
17	2	R3 R4	2.00 M $\Omega$ , 1%, 1/4 W, Thick Film, 1206	ERJ-8ENF2004V	Panasonic
18	1	R5	1.00 M $\Omega$ , 1%, 1/16 W, Thick Film, 0603	ERJ-3EKF1004V	Panasonic
19	1	R6	24.9 k $\Omega$ , 1%, 1/16 W, Thick Film, 0603	ERJ-3EKF2492V	Panasonic
20	1	R7	76.8 k $\Omega$ , 1%, 1/16 W, Thick Film, 0603	ERJ-3EKF7682V	Panasonic
21	1	R8	34.8 k $\Omega$ , 1%, 1/16 W, Thick Film, 0603	ERJ-3EKF3482V	Panasonic
22	1	R9	90.9 k $\Omega$ , 1%, 1/16 W, Thick Film, 0603	ERJ-3EKF9092V	Panasonic
23	1	R10	47 k $\Omega$ , 5%, 1/10 W, Thick Film, 0603	ERJ-3GEYJ473V	Panasonic
24	1	R12	0 $\Omega$ , 5%, 1/4 W, Thick Film, 1206	ERJ-8GEY0R00V	Panasonic
25	1	RV1	275 V, 23 J, 7 mm, RADIAL	V275LA4P	Littlefuse
26	1	U1	LinkSwitch-PH, LNK405EG, eSIP	LNK405EG	Power Integrations

### 6.2 Optional OVP Circuit

Item	Qty	Ref Des	Description	Mfg Part Number	Mfg
1	1	VR1	47 V, 5%, 500 mW, DO-35	1N5261B-T	Diodes Inc
2	1	SCR1	SCR, 400 V, 10 A, TO-251	S4010VS3	Littelfuse
3	1	R11	10 k $\Omega$ , 5%, 1/10 W, Thick Film, 0603	ERJ-3GEYJ103V	Panasonic
4	1	C7	10 nF 50 V, Ceramic, X7R, 0603	ECJ-1VB1H103K	Panasonic



### 6.3 Mechanical

Item	Qty	Ref Des	Description	Mfg Part Number	Mfg
1	1	HSK	RD257_HSK		
2	1	SCREW1	SCREW MACHINE PHIL Flat head 4-40 X 1/4 SS		
3	1	ESIP CLIP1	Heat sink Hardware, Edge Clip 16.5 mm L x 7.5 mm W x 0.5 mm H	PH-3	
4	1	NUT1	Nut, Hex 4-40, SS		
5	1	TE1	Terminal, Eyelet, Tin Plated Brass, Zierick PN 190	190	Zierick
6	1	TP1	Test Point, WHT, Miniature THRU-HOLE MOUNT	5002	Keystone
7	2	TP2 TP4	Test Point, BLK, Miniature THRU-HOLE MOUNT	5001	Keystone
8	1	TP3	Test Point, RED, Miniature THRU-HOLE MOUNT	5000	Keystone



## 7 Heat Sink Assembly

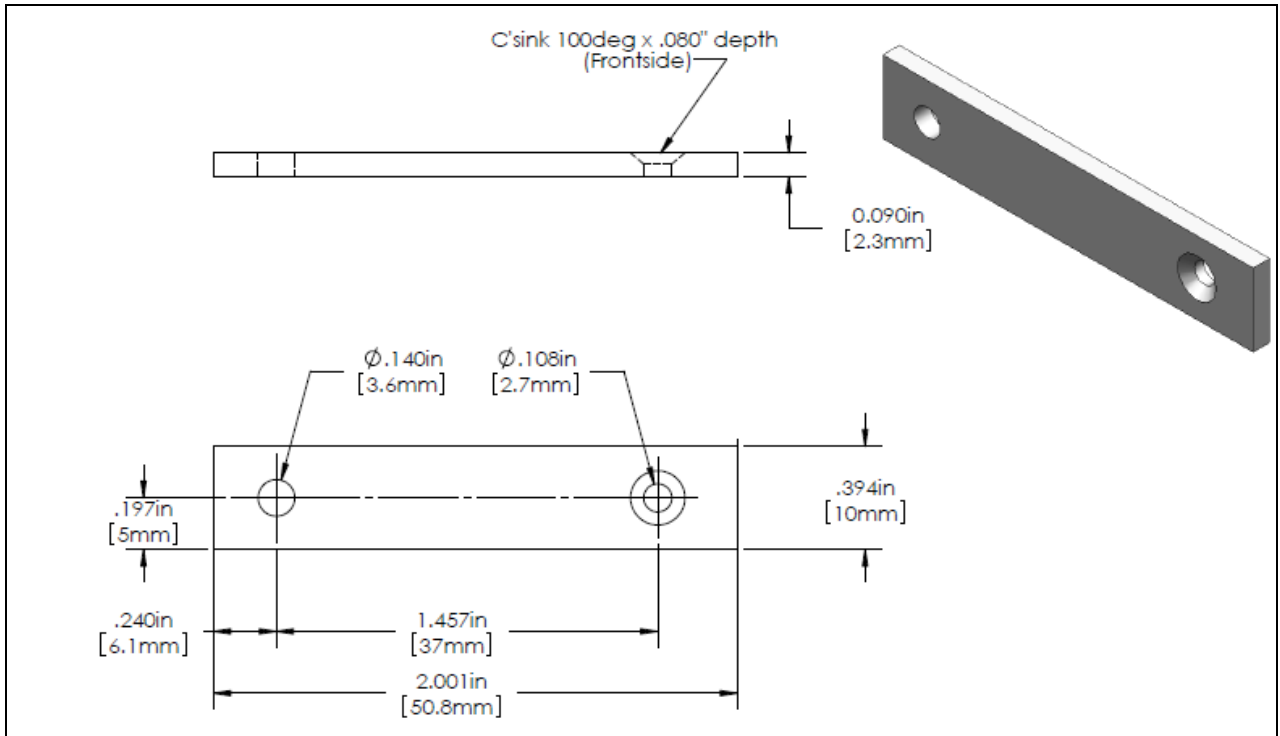


Figure 8 – Heat Sink Dimensions.

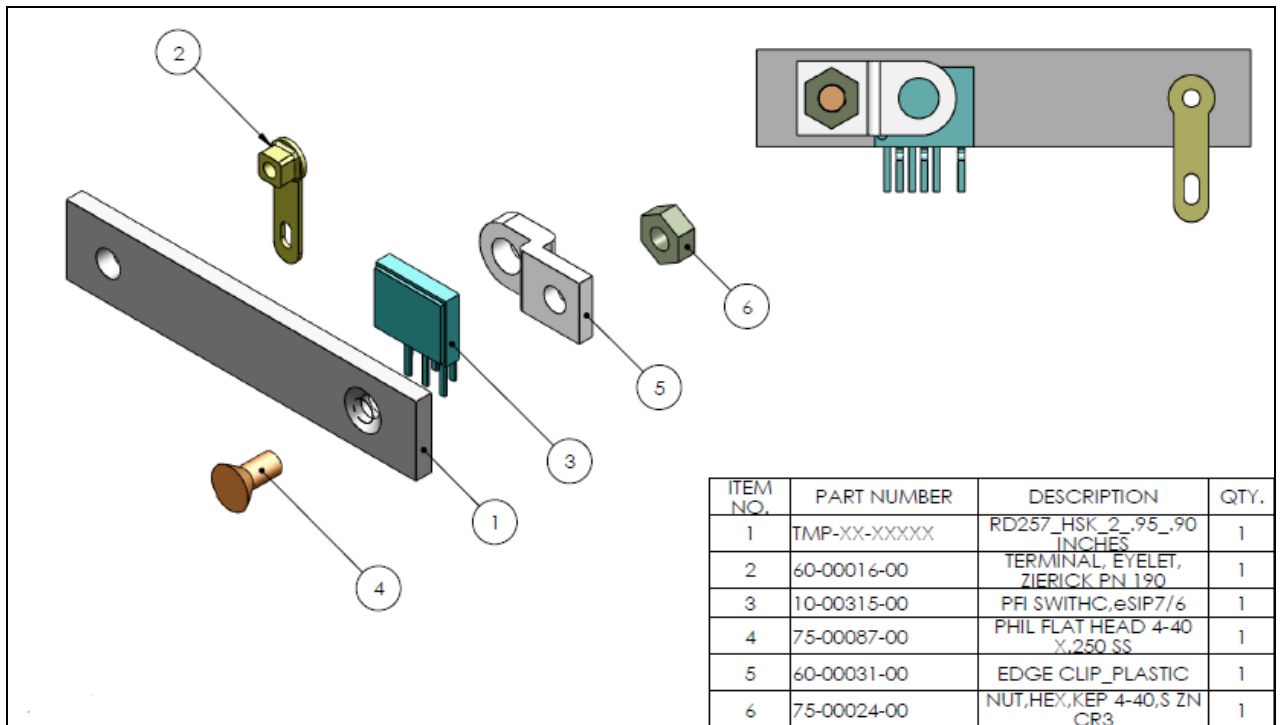


Figure 9 – Heat Sink Assembly Drawing.



## 8 Inductor Specification

### 8.1 Electrical Diagram

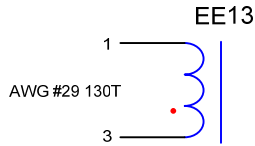


Figure 10 – Inductor Electrical Diagram.

### 8.2 Electrical Specifications

Inductance	Pins 1-3, all other windings open, measured at 66 kHz, 0.4 VRMS	680 $\mu$ H $\pm$ 5%
Resonant Frequency	Pins 1-3, all other windings open	1 MHz (Min.)

### 8.3 Materials

Item	Description
[1]	Core: PC44 EE13 (NC2H)
[2]	Bobbin: EE13, Vertical, 10 pins, 5/5.
[3]	Magnet Wire: #29 AWG.
[4]	Tape: 3M 1298 Polyester Film, 7.5 mm wide.

### 8.4 Inductor Build Diagram

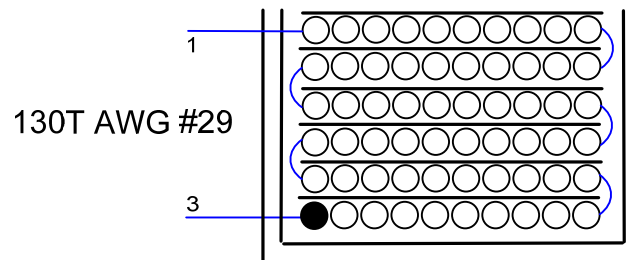


Figure 11 – Inductor Build Diagram.

## 9 Performance Data

The following data were measured using 3 sets of load (i.e. 11, 12, and 13 LED strings to represent the load range of 30 V ~ 36 V output voltage). Refer to the table on Section 9.6 for the complete set of test data values. All measurements performed at room temperature.

### 9.1 Efficiency

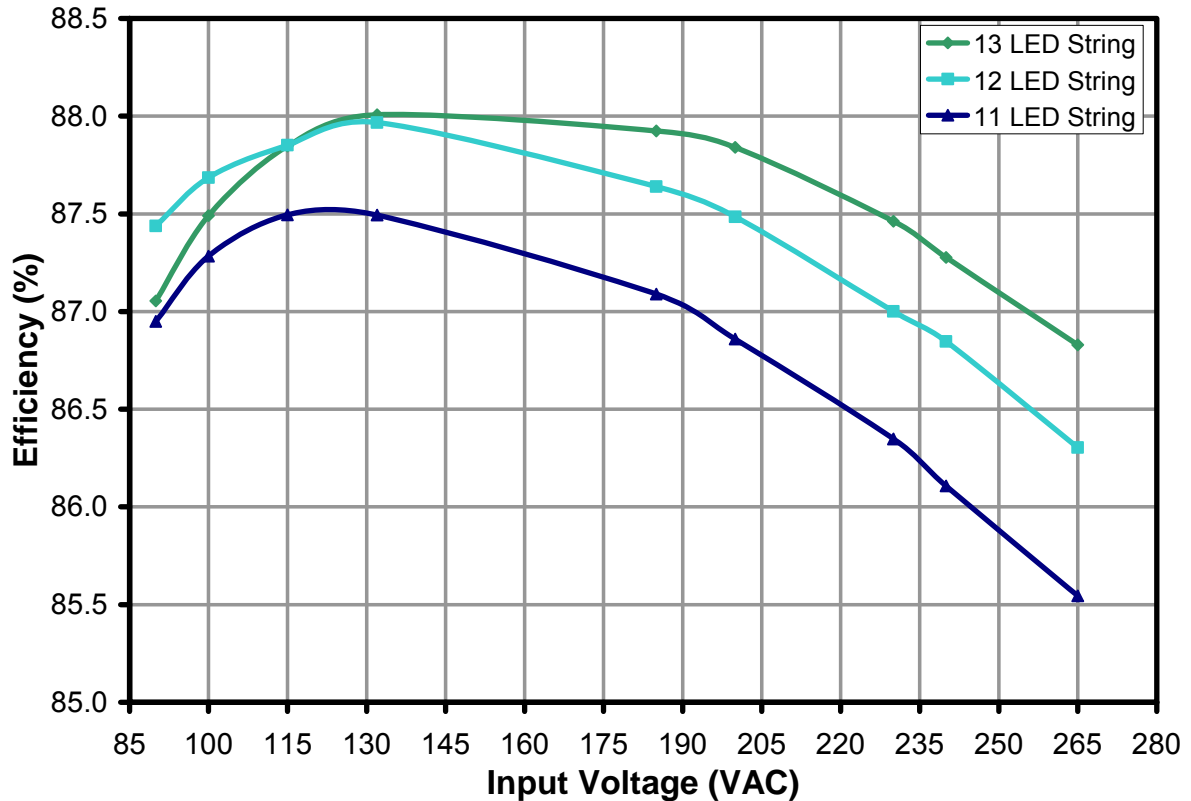


Figure 12 – Efficiency vs. Load and Input Voltage.





### 9.2 Line and Load Regulation

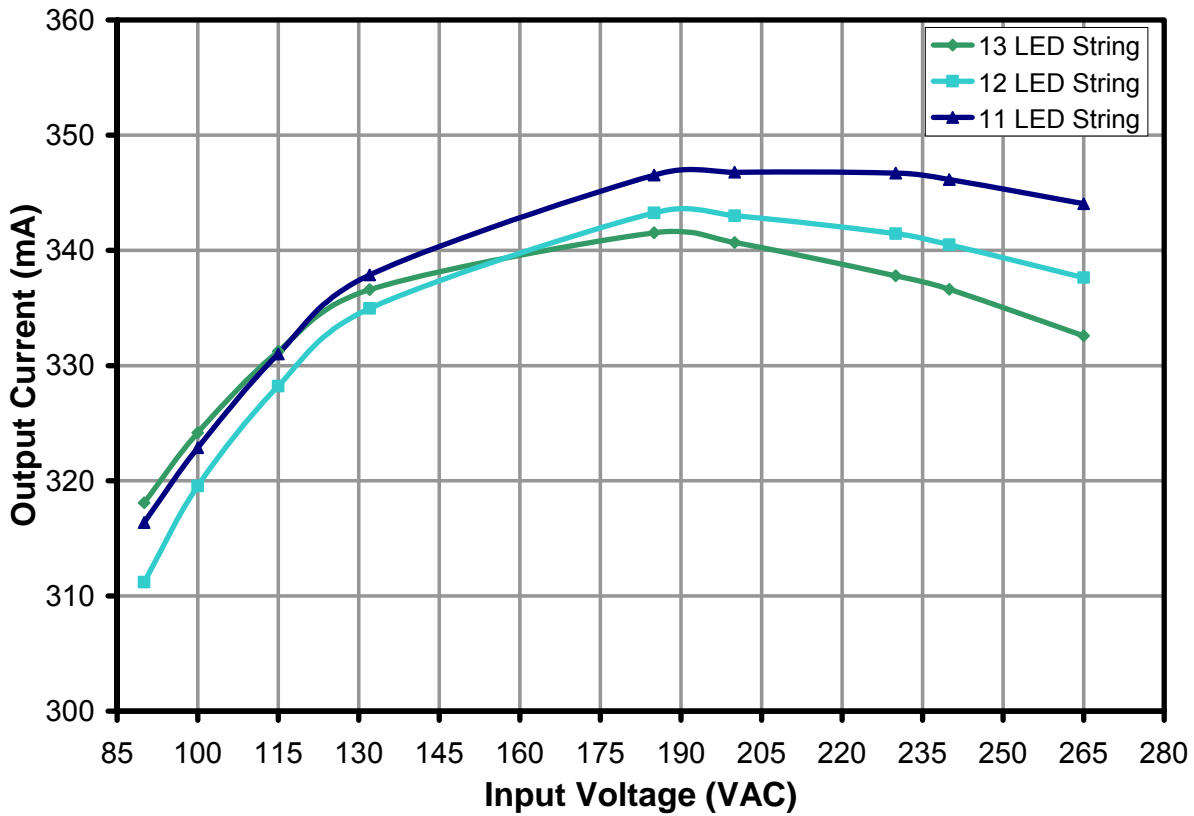


Figure 13 – Regulation vs. Load and Input Voltage.



### 9.3 Power Factor

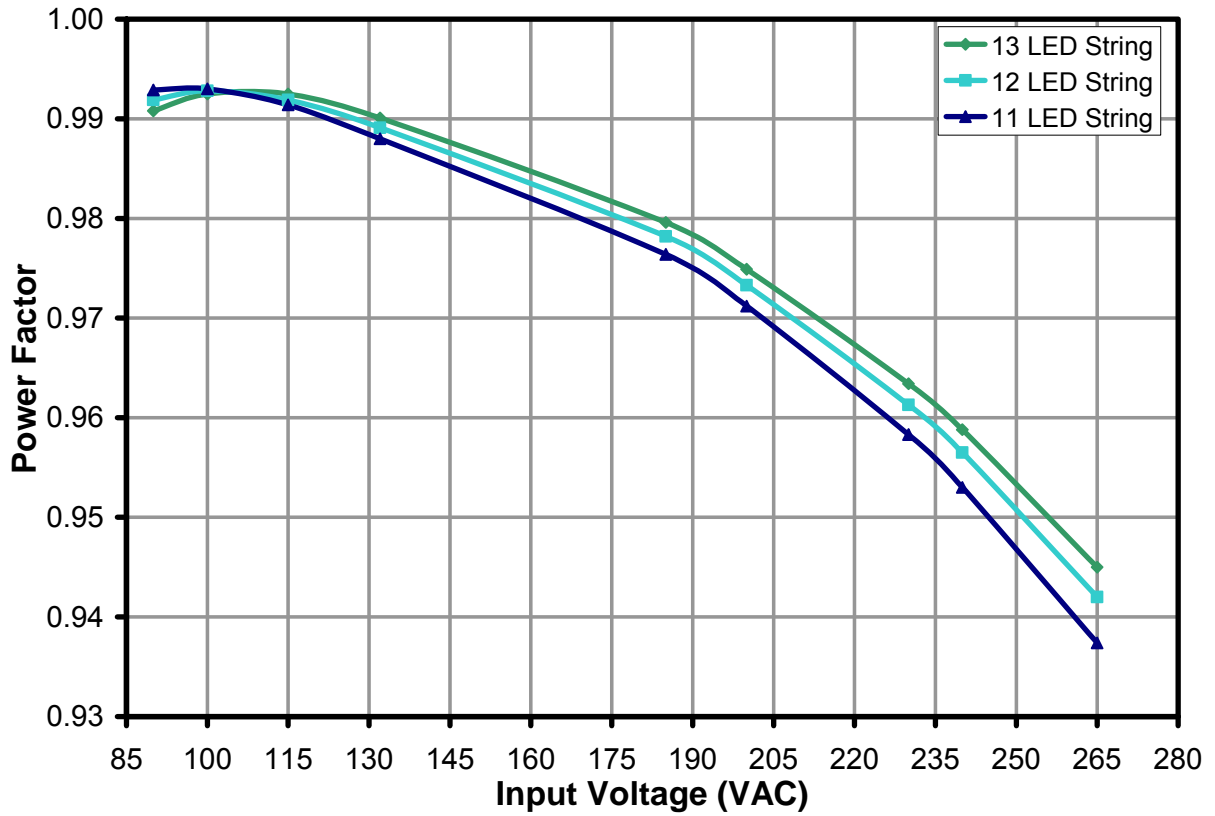


Figure 14 – Power Factor vs. Load and Input Voltage.



### 9.4 THD

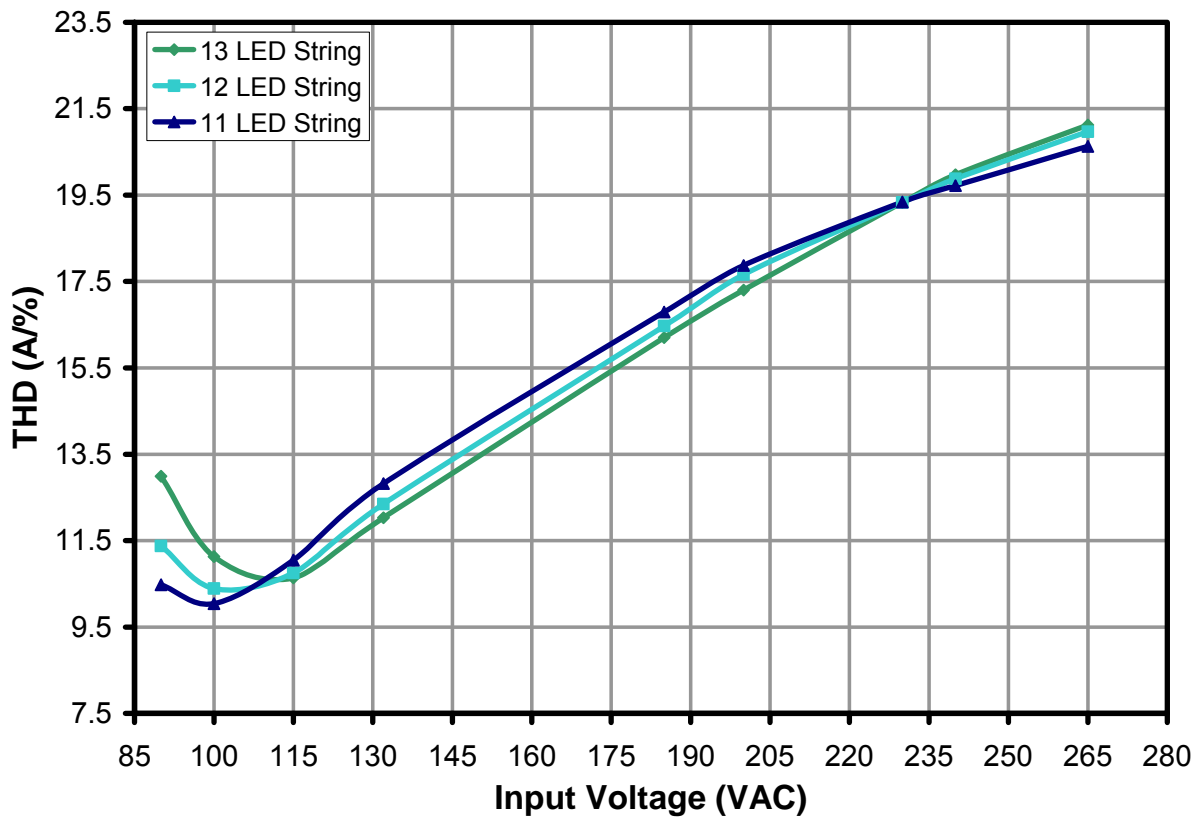


Figure 15 – THD vs. Load and Input Voltage.



### 9.5 Harmonics

Per IEC 61000-3-2 (2005) for Class C compliance for an active input power <25 W requires meeting Class D limits. Where Figures 15 and 16 show Class D limits these are intended to show the limits for Class C compliance (Class D limits).

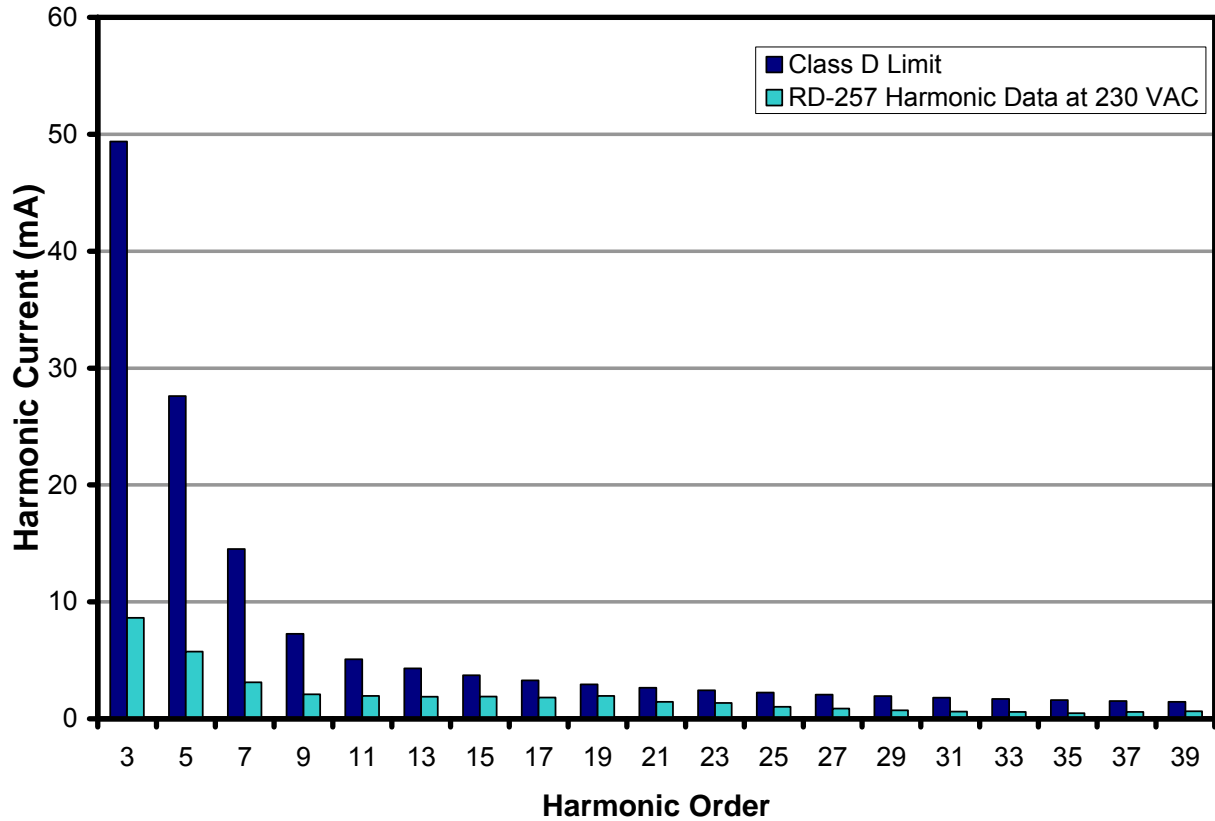


Figure 16 – 230 VAC Input, 50 HZ Current Harmonics.



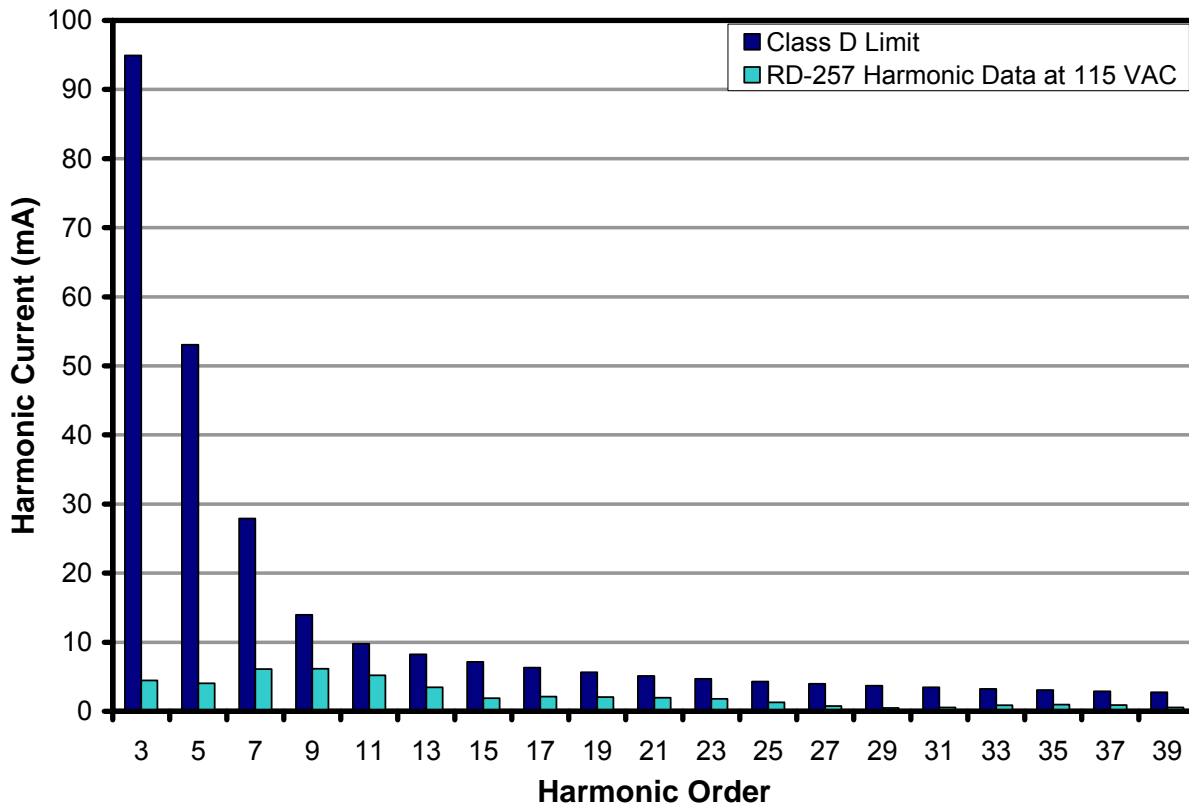


Figure 17 – 115 VAC Input, 60 Hz Current Harmonics.



## 9.6 Test Data

All measurements were taken with the board at open frame, 25°C ambient

### 9.6.1 Test Data, 13 LED Load

V <sub>IN</sub> (VAC)	F <sub>LINE</sub> (Hz)	P <sub>IN</sub> (W)	PF	A-THD (%)	I <sub>OUT</sub> (mA)	V <sub>OUT</sub> (V)	P <sub>OUT</sub> (W)	Efficiency (%)
90	60	13.68	0.991	12.99	318.1	36.99	11.91	87.1
100	60	13.87	0.993	11.13	324.2	37.00	12.14	87.5
115	60	14.12	0.993	10.64	331.3	37.03	12.40	87.8
132	60	14.31	0.990	12.03	336.6	37.04	12.59	88.0
185	50	14.55	0.980	16.20	341.5	37.03	12.79	87.9
200	50	14.52	0.975	17.30	340.7	37.01	12.76	87.8
230	50	14.46	0.963	19.33	337.8	37.02	12.65	87.5
240	50	14.43	0.959	19.97	336.6	37.01	12.59	87.3
265	50	14.32	0.945	21.12	332.6	37.00	12.43	86.8

### 9.6.2 Test Data, 12 LED Load

V <sub>IN</sub> (VAC)	F <sub>LINE</sub> (Hz)	P <sub>IN</sub> (W)	PF	A-THD (%)	I <sub>OUT</sub> (mA)	V <sub>OUT</sub> (V)	P <sub>OUT</sub> (W)	Efficiency (%)
90	60	12.45	0.992	11.38	311.2	34.53	10.89	87.4
100	60	12.75	0.993	10.39	319.6	34.56	11.18	87.7
115	60	13.07	0.992	10.75	328.2	34.59	11.48	87.9
132	60	13.33	0.989	12.35	335.0	34.62	11.73	88.0
185	50	13.72	0.978	16.47	343.3	34.60	12.03	87.6
200	50	13.74	0.973	17.66	343.0	34.62	12.02	87.5
230	50	13.74	0.961	19.33	341.5	34.62	11.95	87.0
240	50	13.73	0.957	19.88	340.5	34.59	11.92	86.8
265	50	13.69	0.942	20.97	337.6	34.61	11.82	86.3

### 9.6.3 Test Data, 11 LED Load

V <sub>IN</sub> (VAC)	F <sub>LINE</sub> (Hz)	P <sub>IN</sub> (W)	PF	A-THD (%)	I <sub>OUT</sub> (mA)	V <sub>OUT</sub> (V)	P <sub>OUT</sub> (W)	Efficiency (%)
90	60	11.67	0.993	10.48	316.4	31.67	10.15	86.9
100	60	11.88	0.993	10.04	322.9	31.69	10.37	87.3
115	60	12.16	0.991	11.05	331.0	31.72	10.64	87.5
132	60	12.39	0.988	12.82	337.9	31.71	10.84	87.5
185	50	12.80	0.976	16.79	346.5	31.72	11.14	87.1
200	50	12.84	0.971	17.87	346.8	31.72	11.15	86.9
230	50	12.91	0.958	19.34	346.7	31.71	11.15	86.3
240	50	12.92	0.953	19.72	346.2	31.71	11.13	86.1
265	50	12.93	0.937	20.63	344.1	31.73	11.06	85.5



9.6.4 230 VAC, 50 Hz Harmonics Data,  $P_{IN} = 14.529$  W

## 9.6.4.1 EN61000-3-2

n	Measured (mA)	Base I Harmonics (mA/W)	230 V Limit (mA)	Remarks
1	64.070			
2	0.050			
3	8.630	3.40000	49.399	Pass
5	5.750	1.90000	27.605	Pass
7	3.120	1.00000	14.529	Pass
9	2.080	0.50000	7.265	Pass
11	1.960	0.35000	5.085	Pass
13	1.870	0.29615	4.303	Pass
15	1.890	0.25667	3.729	Pass
17	1.830	0.22647	3.290	Pass
19	1.960	0.20263	2.944	Pass
21	1.440	0.18333	2.664	Pass
23	1.340	0.16739	2.432	Pass
25	1.030	0.15400	2.237	Pass
27	0.870	0.14259	2.072	Pass
29	0.730	0.13276	1.929	Pass
31	0.610	0.12419	1.804	Pass
33	0.590	0.11667	1.695	Pass
35	0.470	0.11000	1.598	Pass
37	0.580	0.10405	1.512	Pass
39	0.640	0.09872	1.434	Pass





9.6.5 115 VAC, 60 Hz Harmonics Data,  $P_{IN} = 13.96$  W

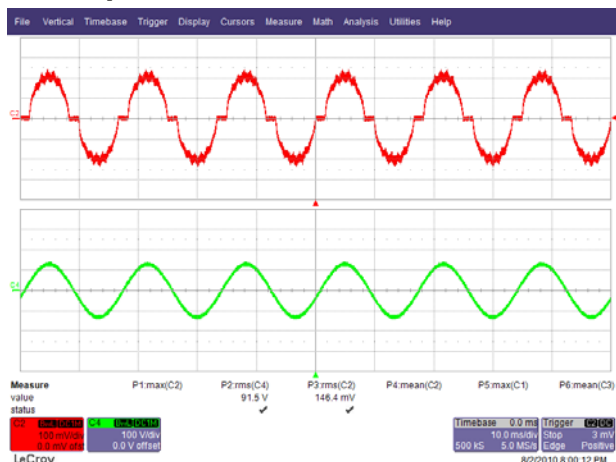
## 9.6.5.1 EN61000-3-2

n	Measured (mA)	Base I Harmonics (mA/W)	115 V Limit (mA)	Remarks
1	121.260			
2	0.210			
3	4.450	3.40000	94.928	Pass
5	4.060	1.90000	53.048	Pass
7	6.110	1.00000	27.920	Pass
9	6.150	0.50000	13.960	Pass
11	5.210	0.35000	9.772	Pass
13	3.470	0.29615	8.269	Pass
15	1.900	0.25667	7.166	Pass
17	2.110	0.22647	6.323	Pass
19	2.060	0.20263	5.657	Pass
21	1.960	0.18333	5.119	Pass
23	1.790	0.16739	4.674	Pass
25	1.270	0.15400	4.300	Pass
27	0.770	0.14259	3.981	Pass
29	0.480	0.13276	3.707	Pass
31	0.540	0.12419	3.467	Pass
33	0.870	0.11667	3.257	Pass
35	0.960	0.11000	3.071	Pass
37	0.890	0.10405	2.905	Pass
39	0.540	0.09872	2.756	Pass

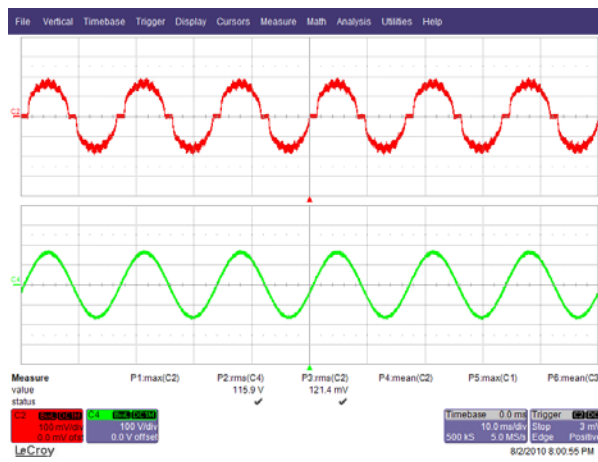


## 10 Waveforms

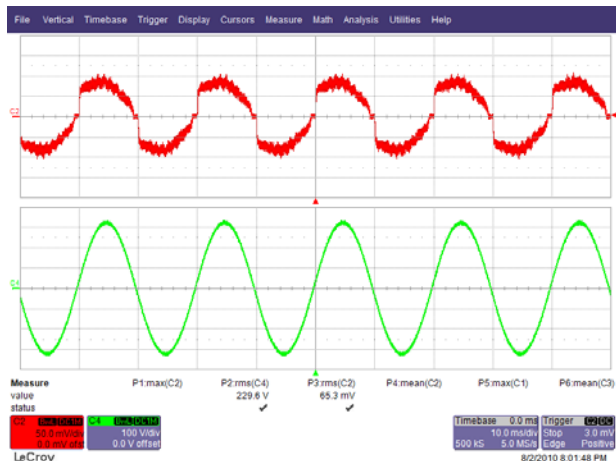
### 10.1 Input Line Current



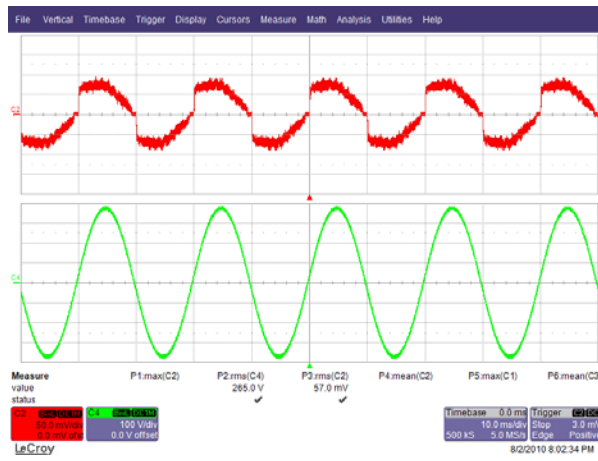
**Figure 18** – 90 VAC 60 Hz, Full Load.  
 Upper:  $I_{IN}$ , 100 mA / div.  
 Lower:  $V_{IN}$ , 100 V, 10 ms / div.



**Figure 19** – 115 VAC 60 Hz, Full Load.  
 Upper:  $I_{IN}$ , 100 mA / div.  
 Lower:  $V_{IN}$ , 100 V, 10 ms / div.



**Figure 20** – 230 VAC 50 Hz, Full Load.  
 Upper:  $I_{IN}$ , 50 mA / div.  
 Lower:  $V_{IN}$ , 100 V, 10 ms / div.

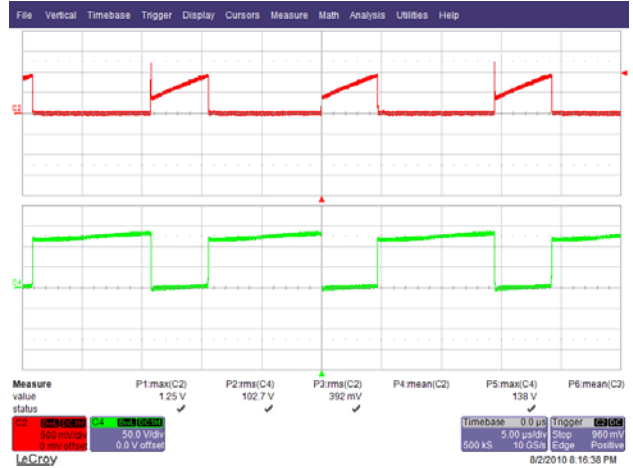


**Figure 21** – 265 VAC 50 Hz, Full Load.  
 Upper:  $I_{IN}$ , 50 mA / div.  
 Lower:  $V_{IN}$ , 100 V, 10 ms / div.

### 10.2 Drain Voltage and Current Normal Operation



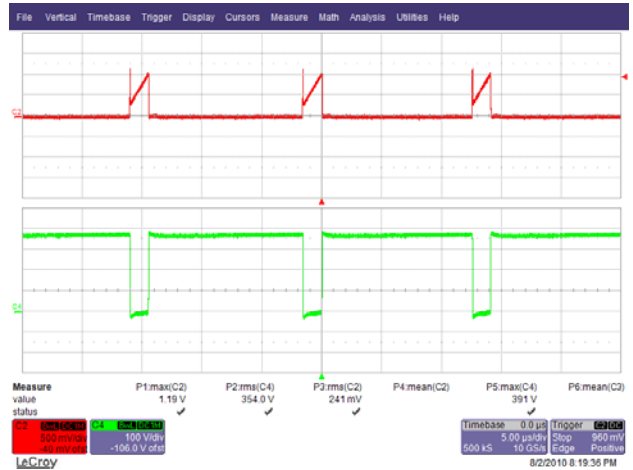
**Figure 22** – 90 VAC 60 Hz, Full Load.  
Upper:  $I_{DRAIN}$ , 500 mA / div.  
Lower:  $V_{DRAIN}$ , 50 V, 5 ms / div.



**Figure 23** – 90 VAC 60 Hz, Full Load.  
Upper:  $I_{DRAIN}$ , 500 mA / div.  
Lower:  $V_{DRAIN}$ , 50 V, 5 μs / div.



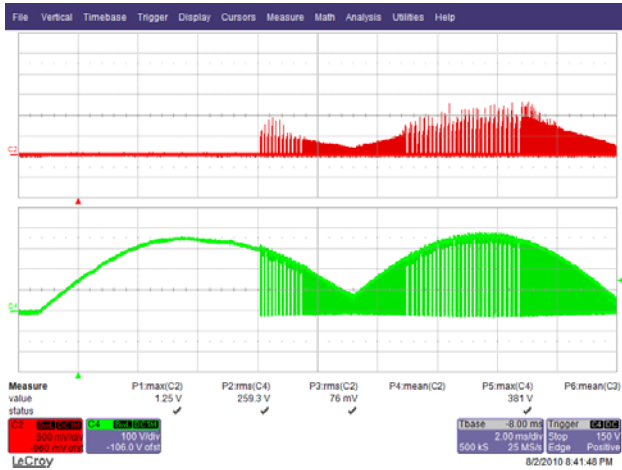
**Figure 24** – 265 VAC 50 Hz, Full Load.  
Upper:  $I_{DRAIN}$ , 500 mA / div.  
Lower:  $V_{DRAIN}$ , 100 V, 5 ms / div.



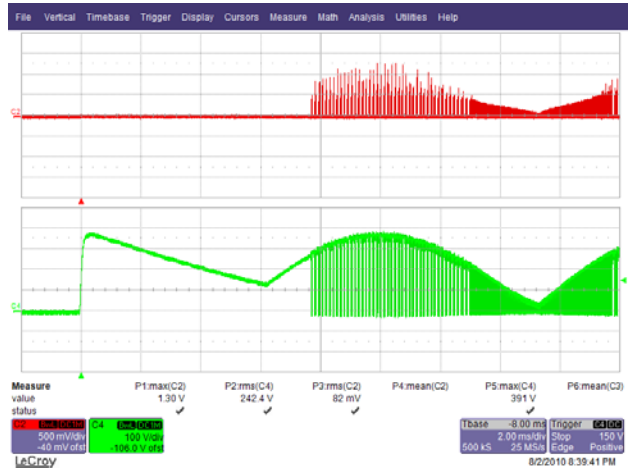
**Figure 25** – 265 VAC 50 Hz, Full Load.  
Upper:  $I_{DRAIN}$ , 500 mA / div.  
Lower:  $V_{DRAIN}$ , 100 V, 5 μs / div.



### 10.3 Drain Voltage and Current Start-up Operation



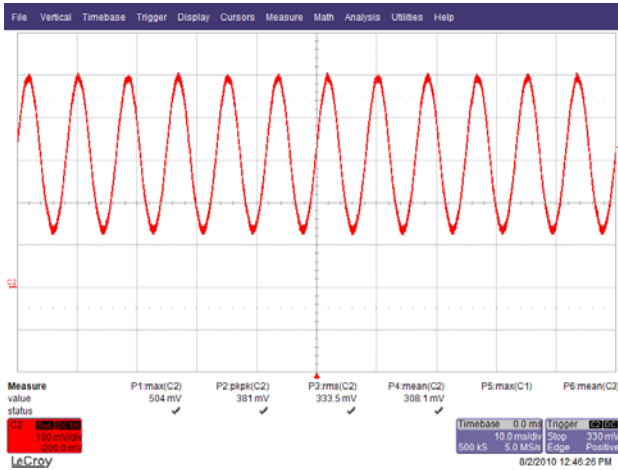
**Figure 26** – 265 VAC 50 Hz, 0° Full Load Start-up.  
 Upper:  $I_{DRAIN}$ , 500 mA / div.  
 Lower:  $V_{DRAIN}$ , 100 V, 2 ms / div.



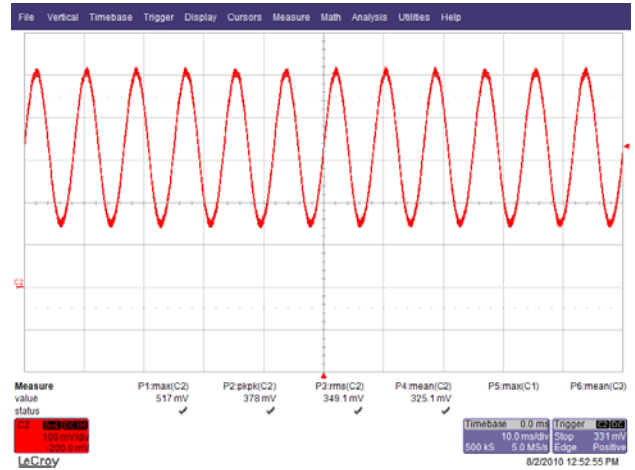
**Figure 27** – 265 VAC 50 Hz, 90° Full Load Start-up.  
 Upper:  $I_{DRAIN}$ , 500 mA / div.  
 Lower:  $V_{DRAIN}$ , 100 V, 2 ms / div.



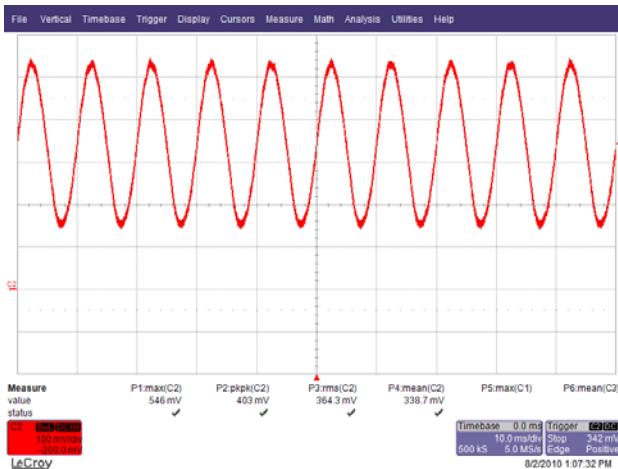
### 10.4 Output Current, Normal Condition, $V_{OUT} \sim 36 V$



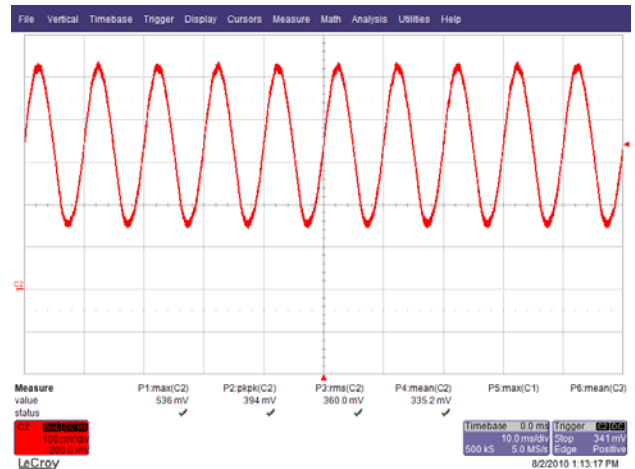
**Figure 28** – 90 VAC 60 Hz, Full Load.  
 $I_{OUT}$ , 100 mA / div., 10 ms / div.



**Figure 29** – 115 VAC 60 Hz, Full Load.  
 $I_{OUT}$ , 100 mA / div., 10 ms / div.

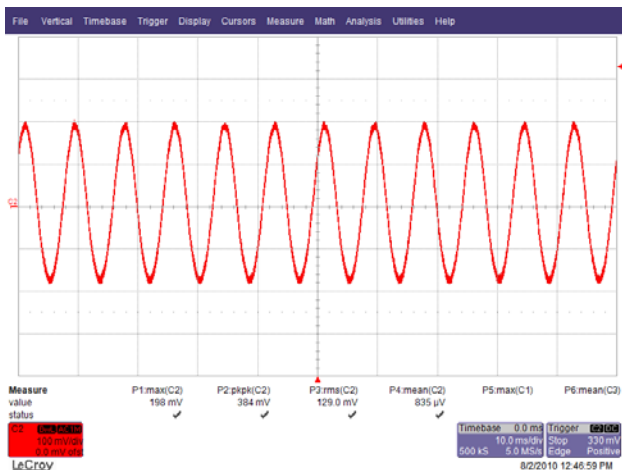


**Figure 30** – 230 VAC 50 Hz, Full Load.  
 $I_{OUT}$ , 100 mA / div., 10 ms / div.

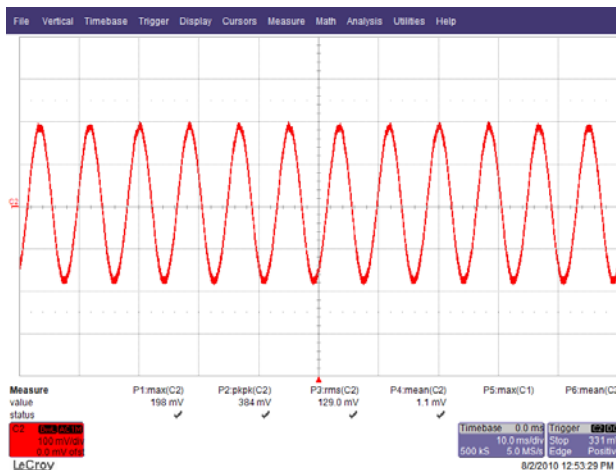


**Figure 31** – 265 VAC 50 Hz, Full Load.  
 $I_{OUT}$ , 100 mA / div., 10 ms / div.

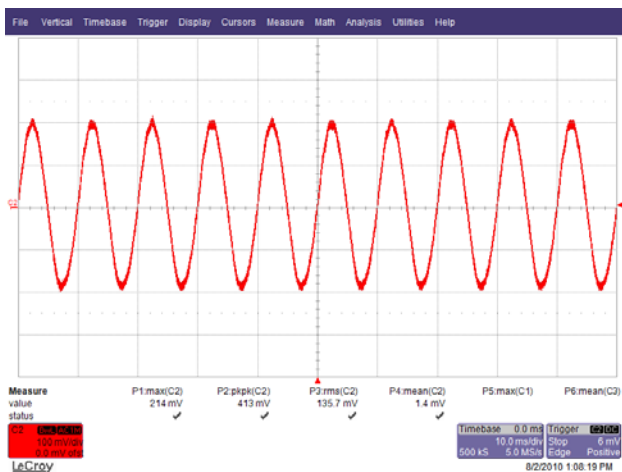
### 10.5 Output Current Ripple, $V_{OUT} \sim 36 V$



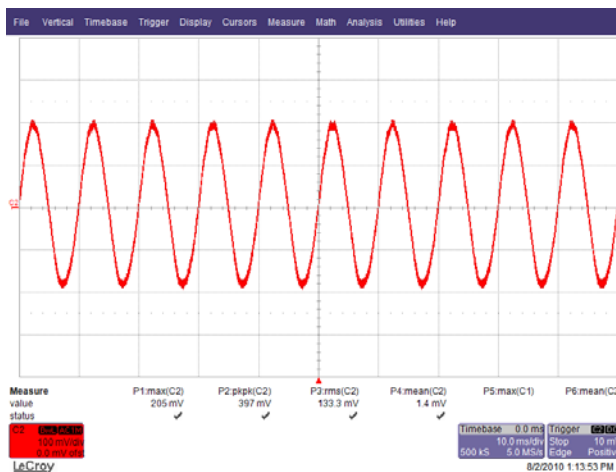
**Figure 32** – 90 VAC 60 Hz, Full Load.  $I_{OUT}$ , AC Coupled, 100 mA / div., 10 ms / div.



**Figure 33** – 115 VAC 60 Hz, Full Load.  $I_{OUT}$ , AC Coupled, 100 mA / div., 10 ms / div.



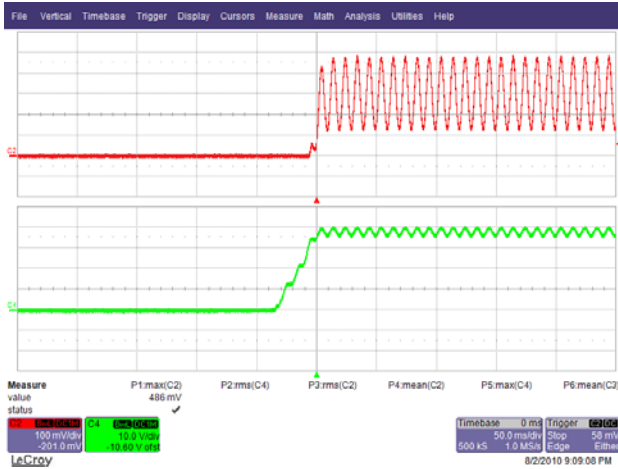
**Figure 34** – 230 VAC 50 Hz, Full Load.  $I_{OUT}$ , AC Coupled, 100 mA / div., 10 ms / div.



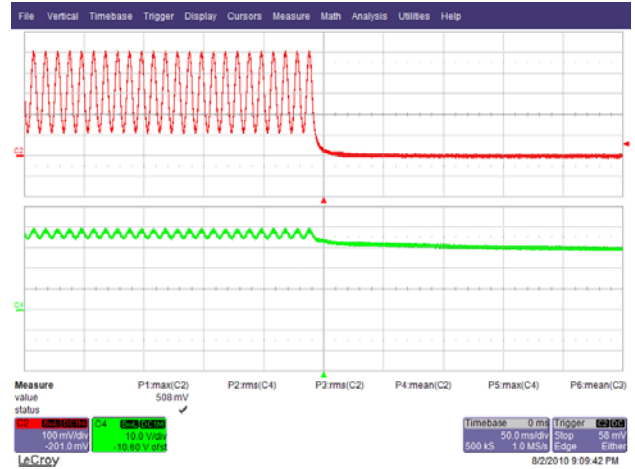
**Figure 35** – 265 VAC 50 Hz, Full Load.  $I_{OUT}$ , AC Coupled, 100 mA / div., 10 ms / div.



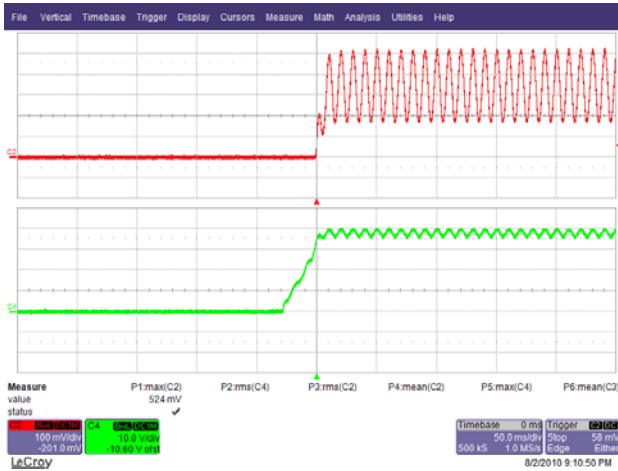
### 10.6 Output Current and Voltage at Power-up, Power-down



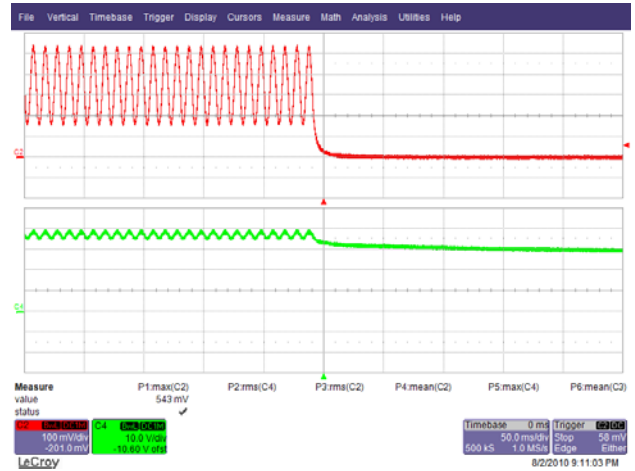
**Figure 36** – 90 VAC 60Hz, Output Rise.  
Upper:  $I_{OUT}$ , 100 mA / div.  
Lower:  $V_{OUT}$ , 10 V, 50 ms / div.



**Figure 37** – 90 VAC 60Hz, Output Fall.  
Upper:  $I_{OUT}$ , 100 mA / div.  
Lower:  $V_{OUT}$ , 10 V, 50 ms / div.



**Figure 38** – 265 VAC 50 Hz, Output Rise.  
Upper:  $I_{OUT}$ , 100 mA / div.  
Lower:  $V_{OUT}$ , 10 V, 50 ms / div.

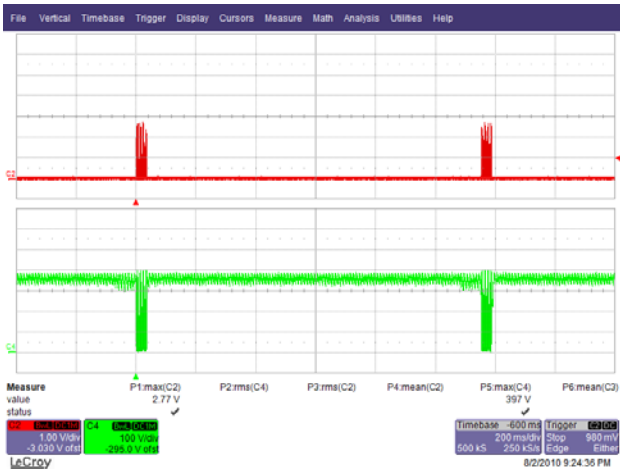


**Figure 39** – 265 VAC 50 Hz, Output Fall.  
Upper:  $I_{OUT}$ , 100 mA / div.  
Lower:  $V_{OUT}$ , 10 V, 50 ms / div.

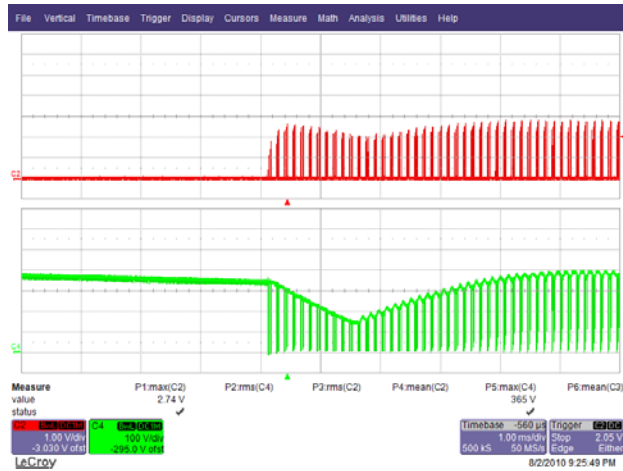




### 10.7 Output Short

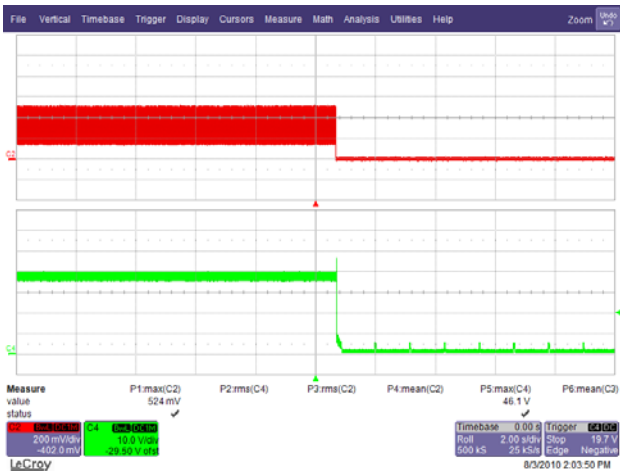


**Figure 40** – 265 VAC 60 Hz, Output Short.  
Upper:  $I_{DRAIN}$ , 1 A / div.  
Lower:  $V_{DRAIN}$ , 100 V, 200 ms / div.

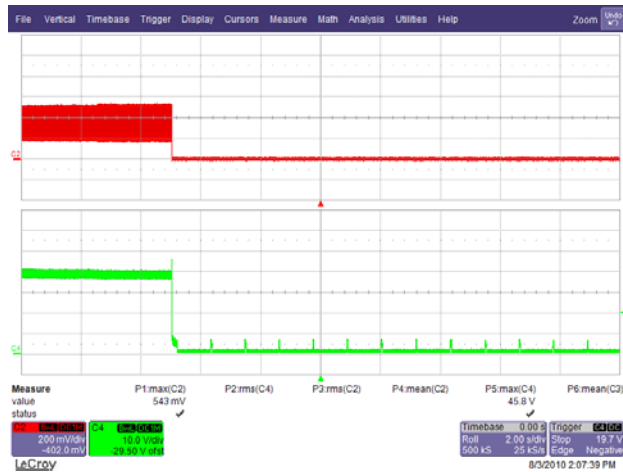


**Figure 41** – 265 VAC 60 Hz, Output Short.  
Upper:  $I_{DRAIN}$ , 1 A / div.  
Lower:  $V_{DRAIN}$ , 100 V, 10 ms / div.

### 10.8 Open Load/LED Condition



**Figure 42** – 90 VAC 60 Hz, Open Load.  
CH2:  $I_{OUT}$ , 200 mA / div.  
CH4:  $V_{OUT}$ , 10 V, 1s / div.



**Figure 43** – 265 VAC 60 Hz, Open Load.  
CH2:  $I_{OUT}$ , 200 mA / div.  
CH4:  $V_{OUT}$ , 10 V, 1s / div.



## 11 Thermal Measurements

### 11.1 Thermal Test Set-up

Thermal Measurements were done with the buck board inside the T8 fixture operated at room temperature. The ambient measurement location inside the assembly is shown below.

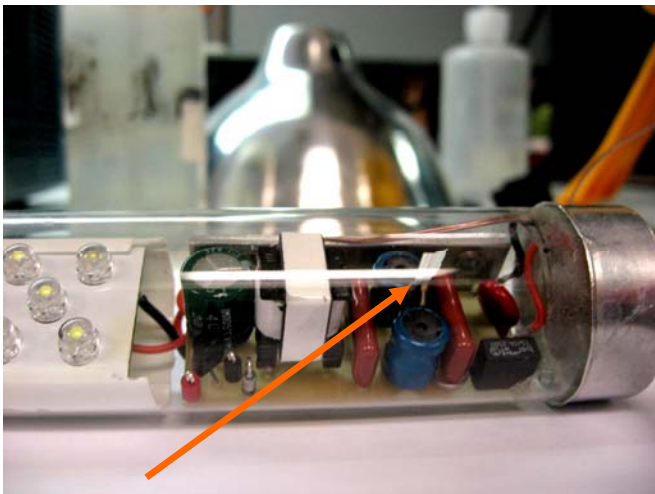


Figure 44 – Ambient Inside Location.

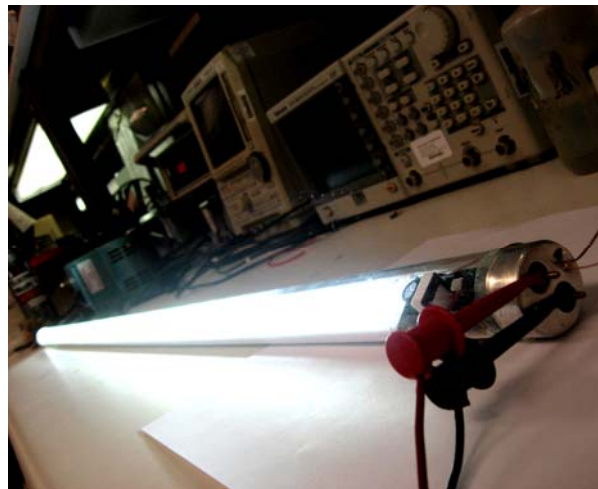


Figure 45 – Thermal Measurement Set-up.

### 11.2 Thermal Test Results

Component / Location	Absolute Temperature, (°C)	
Ambient Inside	66	55
LinkSwitch-PH	83	80
Output Inductor, Wire	76	76
Output Inductor, Core	75	74
EMI Diff-Choke	74	62
Output Capacitor	70	68
Free Wheel Diode	72	69
Ambient (room)	27	26
<b>Input Condition</b>		
$V_{OUT}$ , V	35.54	35.48
$I_{OUT}$ , mA	334.00	321.00
$P_{OUT}$ , W	11.87	11.39
$V_{IN}$ , VAC	90.00	265.00

## 12 Conducted EMI Measurements

### 12.1 Conducted EMI Test Set-up

Conducted EMI were measured with the LED Board inside the T8 tube together with the LED load .The tube is mounted on a typical T8 holder and the metal body of the fixture was connected to earth ground.

Two different set-ups were measured corresponding to the position of the driver with respect to the grounded fixture.

#### 12.1.1 Configuration A: Solder Side of Driver Facing Grounded T8 Fixture

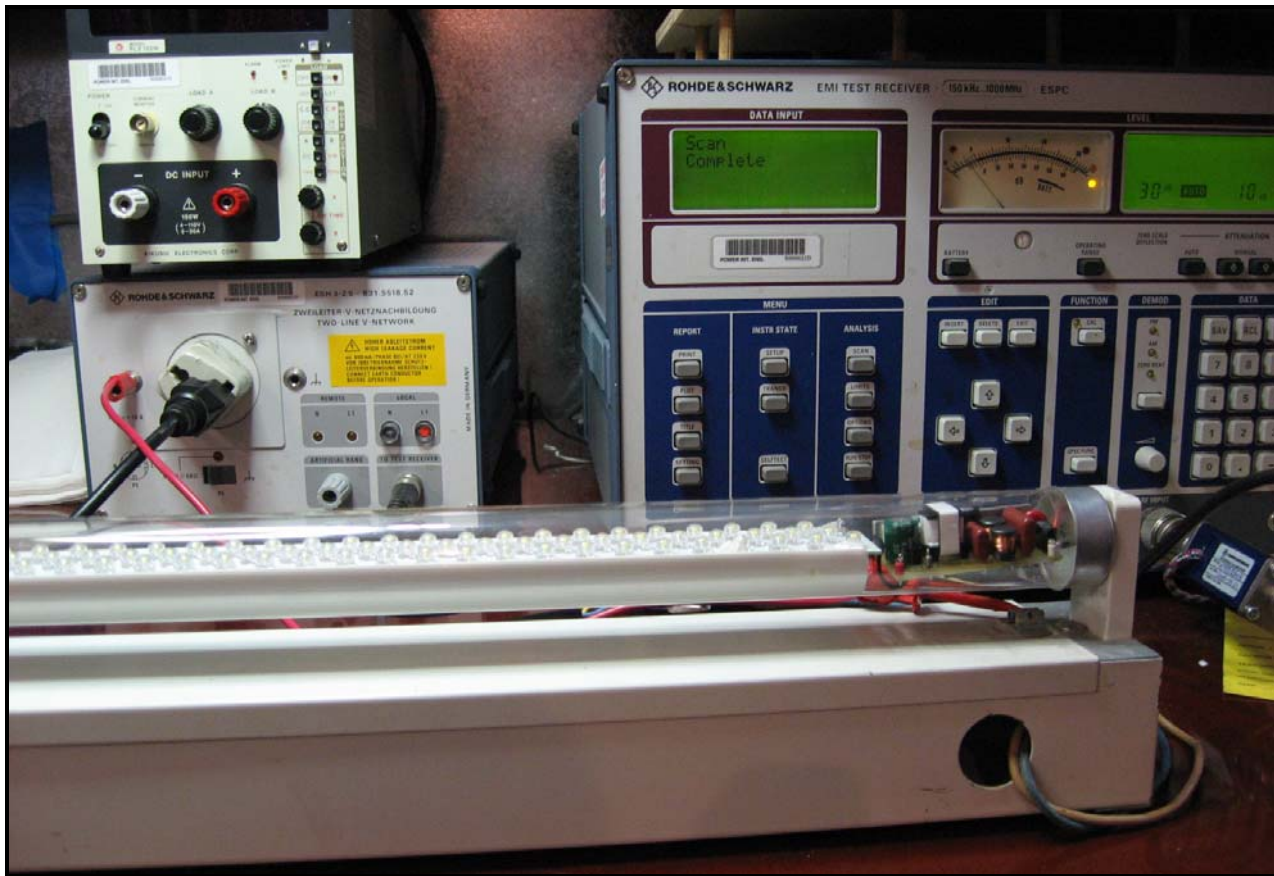


Figure 46 – Configuration A EMI Measurement Set-up.

## 12.1.2 Configuration B: Component Side of Driver Facing Grounded T8 Fixture

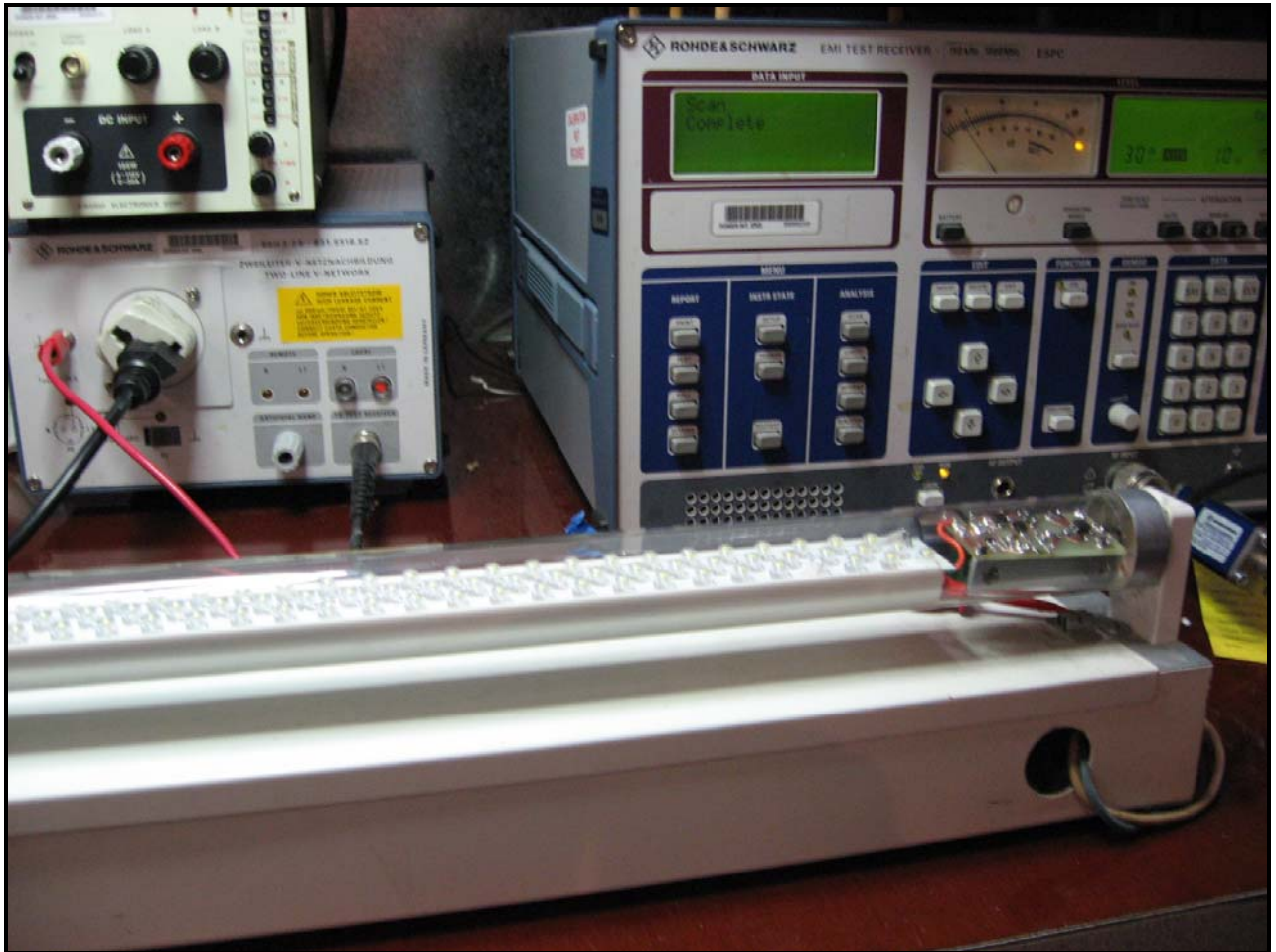


Figure 47 – Configuration B EMI Measurement Set-up.

## 12.2 Conducted EMI Test Results

### 12.3 Configuration A Conducted Emission



EDIT PEAK LIST (Final Measurement Results)					
TRACE		FREQUENCY	LEVEL dBµV		DELTA LIMIT dB
Trace1:	EN55015Q				
Trace2:	EN55015A				
Trace3:	---				
2	Average	67.8393045788 kHz	36.50	L1 gnd	
2	Average	126.977840157 kHz	40.85	N gnd	
2	Average	130.825395691 kHz	43.64	N gnd	
2	Average	133.454986145 kHz	48.07	N gnd	
2	Average	138.873793737 kHz	42.63	N gnd	
2	Average	165.693318812 kHz	36.82	L1 gnd	-18.34
1	Quasi Peak	198.193645035 kHz	53.04	L1 gnd	-10.64
2	Average	198.193645035 kHz	43.54	L1 gnd	-10.13
1	Quasi Peak	264.49018761 kHz	44.90	L1 gnd	-16.38
2	Average	264.49018761 kHz	36.27	L1 gnd	-15.01
1	Quasi Peak	332.507282579 kHz	46.51	L1 gnd	-12.87
2	Average	332.507282579 kHz	35.69	L1 gnd	-13.69
1	Quasi Peak	397.727746704 kHz	45.29	L1 gnd	-12.61
2	Average	397.727746704 kHz	33.62	L1 gnd	-14.27
1	Quasi Peak	598.084042089 kHz	44.56	L1 gnd	-11.43

Figure 48 – Conducted EMI, ~36 V Load, 115 VAC, 60 Hz, and EN55022 B Limits.





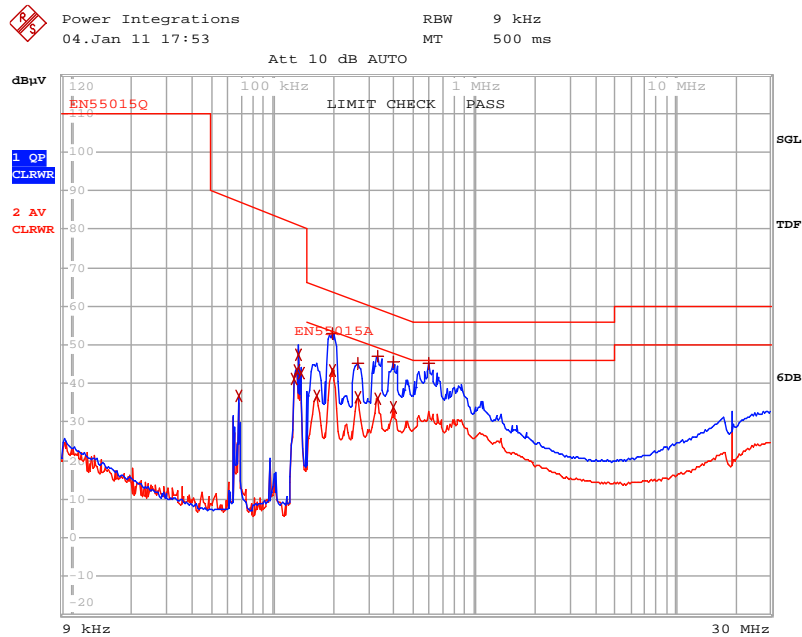


EDIT PEAK LIST (Final Measurement Results)			
TRACE	FREQUENCY	LEVEL dBµV	DELTA LIMIT dB
Trace1:	EN55015Q		
Trace2:	EN55015A		
Trace3:	---		
2 Average	126.977840157 kHz	39.02 L1 gnd	
2 Average	130.825395691 kHz	44.17 L1 gnd	
2 Average	133.454986145 kHz	39.70 N gnd	
2 Average	137.49880568 kHz	30.25 L1 gnd	
2 Average	165.693318812 kHz	34.81 L1 gnd	-20.35
1 Quasi Peak	198.193645035 kHz	53.67 L1 gnd	-10.01
2 Average	198.193645035 kHz	45.06 L1 gnd	-8.62
1 Quasi Peak	264.49018761 kHz	48.20 L1 gnd	-13.08
2 Average	264.49018761 kHz	38.63 L1 gnd	-12.65
1 Quasi Peak	332.507282579 kHz	43.95 L1 gnd	-15.43
2 Average	332.507282579 kHz	34.59 L1 gnd	-14.79
1 Quasi Peak	397.727746704 kHz	41.02 L1 gnd	-16.87
1 Quasi Peak	660.656865747 kHz	44.23 L1 gnd	-11.76
2 Average	660.656865747 kHz	33.59 L1 gnd	-12.40
2 Average	19.2717727102 MHz	30.90 L1 gnd	-19.09

Figure 49 – Conducted EMI, ~36 V Load, 230 VAC, 60 Hz, and EN55022 B Limits.



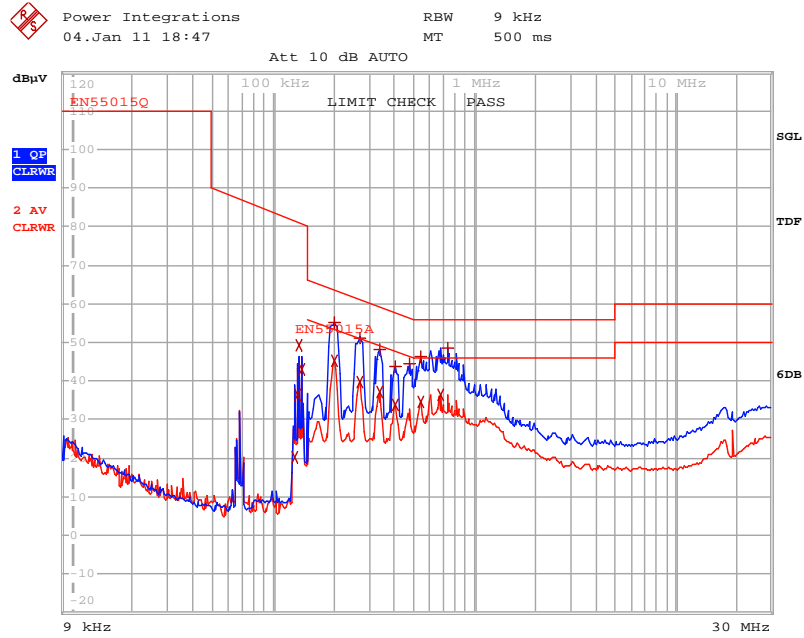
### 12.4 Configuration B Conducted Emission



EDIT PEAK LIST (Final Measurement Results)				
TRACE	FREQUENCY	LEVEL dBµV	DELTA	LIMIT dB
Trace1:	EN55015Q			
Trace2:	EN55015A			
Trace3:	---			
2 Average	67.8393045788 kHz	36.63	L1 gnd	
2 Average	126.977840157 kHz	40.99	L1 gnd	
2 Average	130.825395691 kHz	43.32	N gnd	
2 Average	133.454986145 kHz	47.40	L1 gnd	
2 Average	138.873793737 kHz	42.48	L1 gnd	
2 Average	165.693318812 kHz	36.70	N gnd	-18.46
1 Quasi Peak	198.193645035 kHz	53.11	N gnd	-10.56
2 Average	198.193645035 kHz	43.49	N gnd	-10.18
1 Quasi Peak	264.49018761 kHz	45.24	N gnd	-16.05
2 Average	264.49018761 kHz	36.40	N gnd	-14.88
1 Quasi Peak	332.507282579 kHz	47.00	N gnd	-12.38
2 Average	332.507282579 kHz	36.07	N gnd	-13.31
1 Quasi Peak	397.727746704 kHz	45.76	N gnd	-12.13
2 Average	397.727746704 kHz	33.81	N gnd	-14.08
1 Quasi Peak	598.084042089 kHz	45.24	N gnd	-10.75

Figure 50 – Phase L1: Conducted EMI, ~36 V Load, 115 VAC, 60 Hz, and EN55022 B Limits.





EDIT PEAK LIST (Final Measurement Results)					
TRACE1:		EN55015Q			
TRACE2:		EN55015A			
TRACE3:		---			
TRACE		FREQUENCY	LEVEL dBµV		DELTA LIMIT dB
2	Average	128.247618558 kHz	20.13	L1 gnd	
2	Average	130.825395691 kHz	36.31	L1 gnd	
2	Average	133.454986145 kHz	49.08	L1 gnd	
2	Average	137.49880568 kHz	43.09	N gnd	
1	Quasi Peak	200.175581485 kHz	55.08	N gnd	-8.51
2	Average	202.1773373 kHz	45.17	N gnd	-8.34
1	Quasi Peak	267.135089486 kHz	51.19	N gnd	-10.01
2	Average	267.135089486 kHz	39.86	N gnd	-11.34
1	Quasi Peak	335.832355405 kHz	48.18	N gnd	-11.11
2	Average	335.832355405 kHz	37.06	N gnd	-12.24
1	Quasi Peak	401.705024172 kHz	43.65	N gnd	-14.16
2	Average	401.705024172 kHz	34.00	N gnd	-13.81
1	Quasi Peak	471.030732902 kHz	44.63	N gnd	-11.85
1	Quasi Peak	536.076911993 kHz	46.34	N gnd	-9.65
2	Average	536.076911993 kHz	34.66	N gnd	-11.34
2	Average	673.936068749 kHz	36.58	N gnd	-9.41
1	Quasi Peak	737.073953121 kHz	48.69	N gnd	-7.30

Figure 51 – Phase N: Conducted EMI, ~36 V Load, 230 VAC, 60 Hz, and EN55022 B Limits.





### 13 Power Line Transient Tests

The unit was subjected to  $\pm 2500$  V 100 kHz ring wave, both at 115 VAC and 230 VAC. A test failure was defined as a non-recoverable interruption of output requiring supply repair or recycling of input voltage.

Level (V)	Input Voltage (VAC)	Injection Location	Injection Phase (°)	Type	Test Result (Pass/Fail)
$\pm 2500$	115	L1, L2	0	100 kHz Ring Wave (500 A)	Pass
$\pm 2500$	115	L1, L2	90	100 kHz Ring Wave (500 A)	Pass
$\pm 2500$	230	L1, L2	0	100 kHz Ring Wave (500 A)	Pass
$\pm 2500$	230	L1, L2	90	100 kHz Ring Wave (500 A)	Pass

Note: 500 V Differential Surge test was also carried out and the unit still pass (no damage). However the surge rating of C3 (450 V for 400 V rated) was exceeded. To limit the peak voltage at C3, a higher value capacitance must be used at the peak detector. A 4.7  $\mu$ F capacitor was tested and C3 peak voltage was limited to 464 V. A 450 V rated capacitor is recommended to avoid stressing C3 during these tests.

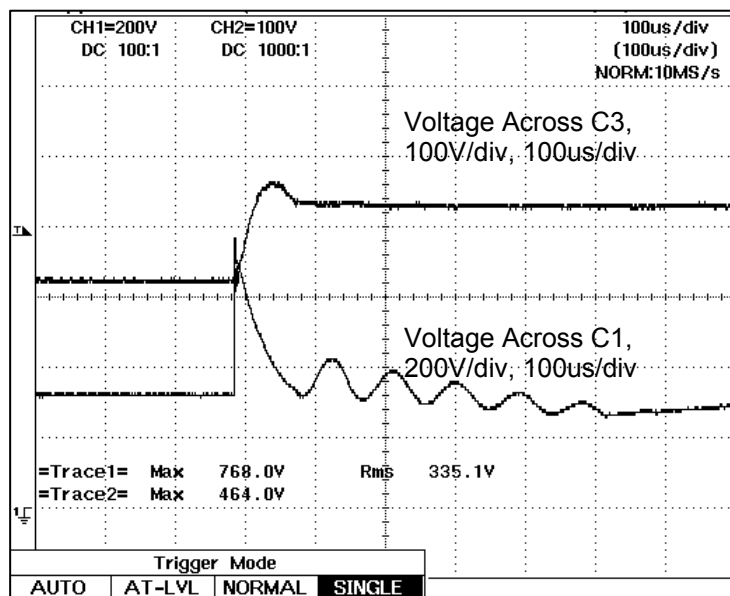


Figure 52 – 500 V Differential Surge, 230 VAC, 90°.



**14 Revision History**

<b>Date</b>	<b>Author</b>	<b>Revision</b>	<b>Description &amp; changes</b>	<b>Reviewed</b>
06-Jan-11	CA	1.0	Initial Release	Apps & Mktg



---

**For the latest updates, visit our website: [www.powerint.com](http://www.powerint.com)**

Power Integrations reserves the right to make changes to its products at any time to improve reliability or manufacturability. Power Integrations does not assume any liability arising from the use of any device or circuit described herein. POWER INTEGRATIONS MAKES NO WARRANTY HEREIN AND SPECIFICALLY DISCLAIMS ALL WARRANTIES INCLUDING, WITHOUT LIMITATION, THE IMPLIED WARRANTIES OF MERCHANTABILITY, FITNESS FOR A PARTICULAR PURPOSE, AND NON-INFRINGEMENT OF THIRD PARTY RIGHTS.

**PATENT INFORMATION**

The products and applications illustrated herein (including transformer construction and circuits external to the products) may be covered by one or more U.S. and foreign patents, or potentially by pending U.S. and foreign patent applications assigned to Power Integrations. A complete list of Power Integrations' patents may be found at [www.powerint.com](http://www.powerint.com). Power Integrations grants its customers a license under certain patent rights as set forth at <http://www.powerint.com/ip.htm>.

The PI Logo, TOPSwitch, TinySwitch, LinkSwitch, DPA-Switch, PeakSwitch, CAPZero, SENZero, LinkZero, HiperPFS, HiperTFS, Qspeed, EcoSmart, Clampless, E-Shield, Filterfuse, StackFET, PI Expert and PI FACTS are trademarks of Power Integrations, Inc. Other trademarks are property of their respective companies. ©Copyright 2011 Power Integrations, Inc.

---

## Power Integrations Worldwide Sales Support Locations

**WORLD HEADQUARTERS**

5245 Hellyer Avenue  
San Jose, CA 95138, USA.  
Main: +1-408-414-9200  
Customer Service:  
Phone: +1-408-414-9665  
Fax: +1-408-414-9765  
*e-mail:*  
[usasales@powerint.com](mailto:usasales@powerint.com)

**GERMANY**

Rueckertstrasse 3  
D-80336, Munich  
Germany  
Phone: +49-89-5527-3911  
Fax: +49-89-5527-3920  
*e-mail:*  
[eurosales@powerint.com](mailto:eurosales@powerint.com)

**JAPAN**

Kosei Dai-3 Building  
2-12-11, Shin-Yokohama,  
Kohoku-ku, Yokohama-shi,  
Kanagawa 222-0033  
Japan  
Phone: +81-45-471-1021  
Fax: +81-45-471-3717  
*e-mail:* [japansales@powerint.com](mailto:japansales@powerint.com)

**TAIWAN**

5F, No. 318, Nei Hu Rd., Sec. 1  
Nei Hu District  
Taipei 114, Taiwan R.O.C.  
Phone: +886-2-2659-4570  
Fax: +886-2-2659-4550  
*e-mail:*  
[taiwansales@powerint.com](mailto:taiwansales@powerint.com)

**CHINA (SHANGHAI)**

Rm 1601/1610, Tower 1  
Kerry Everbright City  
No. 218 Tianmu Road West  
Shanghai, P.R.C. 200070  
Phone: +86-021-6354-6323  
Fax: +86-021-6354-6325  
*e-mail:*  
[chinasales@powerint.com](mailto:chinasales@powerint.com)

**INDIA**

#1, 14<sup>th</sup> Main Road  
Vasanthanagar  
Bangalore-560052  
India  
Phone: +91-80-4113-8020  
Fax: +91-80-4113-8023  
*e-mail:*  
[indiasales@powerint.com](mailto:indiasales@powerint.com)

**KOREA**

RM 602, 6FL  
Korea City Air Terminal B/D, 159-6  
Samsung-Dong, Kangnam-Gu,  
Seoul, 135-728  
Korea  
Phone: +82-2-2016-6610  
Fax: +82-2-2016-6630  
*e-mail:* [koreasales@powerint.com](mailto:koreasales@powerint.com)

**EUROPE HQ**

1st Floor, St. James's House  
East Street, Farnham  
Surrey GU9 7TJ  
United Kingdom  
Phone: +44 (0) 1252-730-141  
Fax: +44 (0) 1252-727-689  
*e-mail:*  
[eurosales@powerint.com](mailto:eurosales@powerint.com)

**CHINA (SHENZHEN)**

Rm A, B & C 4<sup>th</sup> Floor, Block C,  
Electronics Science and  
Technology Building  
2070 Shennan Zhong Road  
Shenzhen, Guangdong,  
P.R.C. 518031  
Phone: +86-755-8379-3243  
Fax: +86-755-8379-5828  
*e-mail:*  
[chinasales@powerint.com](mailto:chinasales@powerint.com)

**ITALY**

Via De Amicis 2  
20091 Bresso MI  
Italy  
Phone: +39-028-928-6000  
Fax: +39-028-928-6009  
*e-mail:*  
[eurosales@powerint.com](mailto:eurosales@powerint.com)

**SINGAPORE**

51 Newton Road,  
#19-01/05 Goldhill Plaza  
Singapore, 308900  
Phone: +65-6358-2160  
Fax: +65-6358-2015  
*e-mail:*  
[singaporesales@powerint.com](mailto:singaporesales@powerint.com)

**APPLICATIONS HOTLINE**

World Wide +1-408-414-9660

**APPLICATIONS FAX**

World Wide +1-408-414-9760

