

Plug-in unit with static trapeziform handle

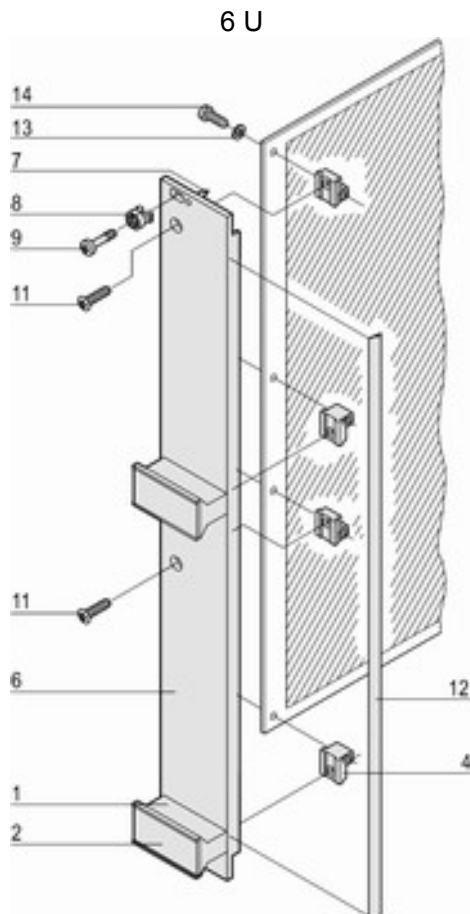

Product illustrations are exemplary illustrations and can deviate from supplied products.

Part no.: 20848-672

Features:

- Handle without extraction function
- Front panel shielded



Technical information:

Height	Width
6 U	4 HP

Downloads:

User Manual ([Log in](#) Required)
User Manual ([Log in](#) Required)
User Manual ([Log in](#) Required)

To gain access to the additional information you must [Log in](#).
If you do not yet have a user name, you may [Register here](#).

Add to basket



Delivery comprises: kit

Item	Qty	Description
1	2	Plastic handle, trapezium shape, PPE, grey
2	2	Identification plate, Al, 1.5 mm, anodised, cut edges plain
4	4	Board bracket, Zn die-cast
6	1	U front panel for trapeziform handle, front anodised, rear conductive
7	2	Alignment pin, pressed-in, stainless steel
8	2	Sleeve, PA, grey, up to 7 HP front panel width
8	4	Sleeve, PA, grey, from 8 HP front panel width
9	2	Pozidrive/slotted collar screw, St, nickel-plated, M2.5 × 11 and 12.3, up to 7 HP front panel width
9	4	Pozidrive/slotted collar screw, St, nickel-plated, M2.5 × 11 and 12.3, from 8 HP front panel width
11	2	Raised countersunk screw, St, nickel-plated, M2.5 × 8
12	1	EMC textile gasket
13	4	Washer, A2.7, DIN 125
14	4	Flathead screw, St, nickel-plated, M2.5 × 10
15	2	Hexagon nut, St, nickel-plated, M2.5
16	2	Flathead screw, St, nickel-plated, M2.5 × 12
17	2	Flathead screw, St, nickel-plated, M2.5 × 16

