

PLEASE CHECK WWW.MOLEX.COM FOR LATEST PART INFORMATION

Part Number: [54132-4597](#)
Status: **Active**
Description: 0.50mm Pitch FFC/FPC Connector, Right Angle, SMT, ZIF, Bottom Contact Style, 45 Circuits, Lead-Free

Documents:

[3D Model](#) [Packaging Specification SPK-54132-001 \(PDF\)](#)
[Drawing \(PDF\)](#) [RoHS Certificate of Compliance \(PDF\)](#)
[Product Specification PS-54132-058 \(PDF\)](#)

Agency Certification

UL E29179

General

Product Family FFC/FPC Connectors
 Series [54132](#)
 Product Name N/A
 UPC 822348116768

Physical

Circuits (Loaded) 45
 Color - Resin Black, Natural
 Contact Position Bottom
 Durability (mating cycles max) 20
 Entry Angle 90° Angle
 Flammability 94V-0
 Mated Height 2.00mm
 Material - Metal Phosphor Bronze
 Material - Plating Mating Tin-Bismuth
 Material - Plating Termination Tin-Bismuth
 Material - Resin High Temperature Thermoplastic
 Net Weight 497.400/mg
 Number of Rows 1
 Orientation Right Angle
 PCB Locator No
 PCB Retention None
 Packaging Type Embossed Tape on Reel
 Pitch - Mating Interface 0.50mm
 Plating min - Mating 1.016µm
 Plating min - Termination 1.016µm
 Polarized to PCB Yes
 Stackable No
 Surface Mount Compatible (SMC) N/A
 Temperature Range - Operating -20°C to +85°C
 Termination Interface: Style Surface Mount
 Wire/Cable Type FFC/FPC

Electrical

Current - Maximum per Contact 0.5A
 Voltage - Maximum 50V

Material Info

Reference - Drawing Numbers

Package Specification SPK-54132-001

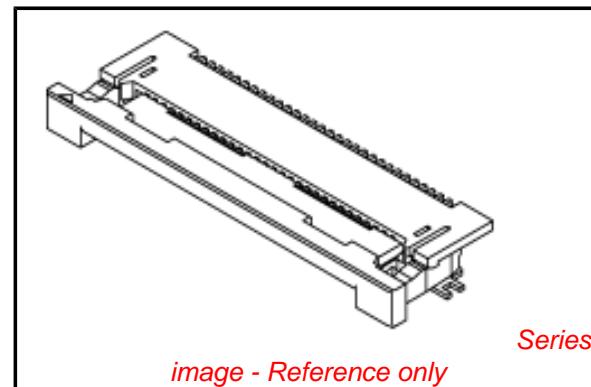

image - Reference only

EU RoHS

**ELV and RoHS
 Compliant**
**REACH SVHC
 Contains SVHC: No
 Low-Halogen Status
 Not Low-Halogen**

China RoHS



**Need more information on product
 environmental compliance?**

Email productcompliance@molex.com
 For a multiple part number RoHS Certificate of Compliance, [click here](#)

Please visit the [Contact Us](#) section for any non-product compliance questions.

Search Parts in this Series

[54132Series](#)

Product Specification

Sales Drawing

PS-54132-058, RPS-54132-064, RPS-54132-067,
RPS-54132-069, RPS-54132-074, RPS-54132-077,
RPS-54132-079
SD-54132-060, SD-54132-061

This document was generated on 03/08/2013

PLEASE CHECK WWW.MOLEX.COM FOR LATEST PART INFORMATION